

XP-60 XP-80

MUSIC WORKSTATION
64 VOICE
4x EXPANSION



OWNER'S MANUAL

Before using this unit, carefully read the sections entitled: "IMPORTANT SAFETY INSTRUCTIONS" (page 2), "USING THE UNIT SAFELY" (page 3), and "IMPORTANT NOTES" (page 4). These sections provide important information concerning the proper operation of the unit. Additionally, in order to feel assured that you have gained a good grasp of every feature provided by your new unit, Quick Start and Owner's Manual should be read in its entirety.
The manuals should be saved and kept on hand as a convenient reference.

For XP-60 Owners

Even though only the XP-80 model is referred to in this manual and in the Quick Start manual, all operations are common to both the XP-80 and XP-60.

Please substitute "XP-60" for each occurrence of "XP-80" that you find in this Owner's Manual and the Quick Start.

	CAUTION RISK OF ELECTRIC SHOCK DO NOT OPEN	
ATTENTION: RISQUE DE CHOC ELECTRIQUE NE PAS OUVRIR		
CAUTION: TO REDUCE THE RISK OF ELECTRIC SHOCK, DO NOT REMOVE COVER (OR BACK). NO USER-SERVICEABLE PARTS INSIDE. REFER SERVICING TO QUALIFIED SERVICE PERSONNEL.		



The lightning flash with arrowhead symbol, within an equilateral triangle, is intended to alert the user to the presence of uninsulated "dangerous voltage" within the product's enclosure that may be of sufficient magnitude to constitute a risk of electric shock to persons.



The exclamation point within an equilateral triangle is intended to alert the user to the presence of important operating and maintenance (servicing) instructions in the literature accompanying the product.

INSTRUCTIONS PERTAINING TO A RISK OF FIRE, ELECTRIC SHOCK, OR INJURY TO PERSONS.

IMPORTANT SAFETY INSTRUCTIONS

SAVE THESE INSTRUCTIONS

WARNING - When using electric products, basic precautions should always be followed, including the following:

1. Read all the instructions before using the product.
2. Do not use this product near water — for example, near a bathtub, washbowl, kitchen sink, in a wet basement, or near a swimming pool, or the like.
3. This product should be used only with a cart or stand that is recommended by the manufacturer.
4. This product, either alone or in combination with an amplifier and headphones or speakers, may be capable of producing sound levels that could cause permanent hearing loss. Do not operate for a long period of time at a high volume level or at a level that is uncomfortable. If you experience any hearing loss or ringing in the ears, you should consult an audiologist.
5. The product should be located so that its location or position does not interfere with its proper ventilation.
6. The product should be located away from heat sources such as radiators, heat registers, or other products that produce heat.
7. The product should be connected to a power supply only of the type described in the operating instructions or as marked on the product.
8. The power-supply cord of the product should be unplugged from the outlet when left unused for a long period of time.
9. Care should be taken so that objects do not fall and liquids are not spilled into the enclosure through openings.
10. The product should be serviced by qualified service personnel when:
 - A. The power-supply cord or the plug has been damaged; or
 - B. Objects have fallen, or liquid has been spilled into the product; or
 - C. The product has been exposed to rain; or
 - D. The product does not appear to operate normally or exhibits a marked change in performance; or
 - E. The product has been dropped, or the enclosure damaged.
11. Do not attempt to service the product beyond that described in the user-maintenance instructions. All other servicing should be referred to qualified service personnel.

For the USA

This product may be equipped with a polarized line plug (one blade wider than the other) . This is a safety feature. If you are unable to insert the plug into the outlet, contact an electrician to replace your obsolete outlet. Do not defeat the safety purpose of the plug.

For Canada

For Polarized Line Plug
CAUTION: TO PREVENT ELECTRIC SHOCK, MATCH WIDE BLADE OF PLUG TO WIDE SLOT, FULLY INSERT.
ATTENTION: POUR ÉVITER LES CHOCS ÉLECTRIQUES, INTRODUIRE LA LAME LA PLUS LARGE DE LA FICHE DANS LA BORNE CORRESPONDANTE DE LA PRISE ET POUSSER JUSQU' AU FOND.

For the U.K.

IMPORTANT: THE WIRES IN THIS MAINS LEAD ARE COLOURED IN ACCORDANCE WITH THE FOLLOWING CODE.

BLUE: NEUTRAL
 BROWN: LIVE

As the colours of the wires in the mains lead of this apparatus may not correspond with the coloured markings identifying the terminals in your plug, proceed as follows:
 The wire which is coloured BLUE must be connected to the terminal which is marked with the letter N or coloured BLACK.
 The wire which is coloured BROWN must be connected to the terminal which is marked with the letter L or coloured RED.
 Under no circumstances must either of the above wires be connected to the earth terminal of a three pin plug.

USING THE UNIT SAFELY

INSTRUCTIONS FOR THE PREVENTION OF FIRE, ELECTRIC SHOCK, OR INJURY TO PERSONS

About ⚠ WARNING and ⚠ CAUTION Notices

⚠ WARNING	Used for instructions intended to alert the user to the risk of death or severe injury should the unit be used improperly.
⚠ CAUTION	Used for instructions intended to alert the user to the risk of injury or material damage should the unit be used improperly. * Material damage refers to damage or other adverse effects caused with respect to the home and all its furnishings, as well to domestic animals or pets.

About the Symbols

	The ⚠ symbol alerts the user to important instructions or warnings. The specific meaning of the symbol is determined by the design contained within the triangle. In the case of the symbol at left, it is used for general cautions, warnings, or alerts to danger.
	The ⚡ symbol alerts the user to items that must never be carried out (are forbidden). The specific thing that must not be done is indicated by the design contained within the circle. In the case of the symbol at left, it means that the unit must never be disassembled.
	The ⚡ symbol alerts the user to things that must be carried out. The specific thing that must be done is indicated by the design contained within the circle. In the case of the symbol at left, it means that the power-cord plug must be unplugged from the outlet.

ALWAYS OBSERVE THE FOLLOWING

⚠ WARNING

- Before using this unit, make sure to read the instructions below, and the Owner's Manual.
- Do not open or perform any internal modifications on the unit. (The only exception would be where this manual provides specific instructions which should be followed in order to put in place user-installable options; see page 45.)
- When using the unit with a rack or stand recommended by Roland, the rack or stand must be carefully placed so it is level and sure to remain stable. If not using a rack or stand, you still need to make sure that any location you choose for placing the unit provides a level surface that will properly support the unit, and keep it from wobbling.
- Avoid damaging the power cord. Do not bend it excessively, step on it, place heavy objects on it, etc. A damaged cord can easily become a shock or fire hazard. Never use a power cord after it has been damaged.
- In households with small children, an adult should provide supervision until the child is capable of following all the rules essential for the safe operation of the unit.
- Protect the unit from strong impact. (Do not drop it!)
- Do not force the unit's power-supply cord to share an outlet with an unreasonable number of other devices. Be especially careful when using extension cords—the total power used by all devices you have connected to the extension cord's outlet must never exceed the power rating (watts/amperes) for the extension cord. Excessive loads can cause the insulation on the cord to heat up and eventually melt through.

⚠ WARNING

- Before using the unit in a foreign country, consult with your retailer, the nearest Roland Service Center, or an authorized Roland distributor, as listed on the "Information" page.
- Always turn the unit off and unplug the power cord before attempting installation of the circuit board (SR-JV80 series; page 45).

⚠ CAUTION

- Always grasp only the plug on the power-supply cord when plugging into, or unplugging from an outlet.
- Try to prevent cords and cables from becoming entangled. Also, all cords and cables should be placed so they are out of the reach of children.
- Never climb on top of, nor place heavy objects on the unit.
- Never handle the power cord or its plug with wet hands when plugging into, or unplugging from, an outlet.
- Before moving the unit, disconnect the power plug from the outlet, and pull out all cords from external devices.
- Before cleaning the unit, turn off the power and unplug the power cord from the outlet (page 4).
- Whenever you suspect the possibility of lightning in your area, pull the plug on the power cord out of the outlet.
- Install only the specified circuit board(s) (SR-JV80 series). Remove only the specified screws (page 45).

IMPORTANT NOTES

In addition to the items listed under “IMPORTANT SAFETY INSTRUCTIONS” and “USING THE UNIT SAFELY” on pages 2 and 3, please read and observe the following:

Power Supply

- Do not use this unit on the same power circuit with any device that will generate line noise (such as an electric motor or variable lighting system).
- Before connecting this unit to other devices, turn off the power to all units. This will help prevent malfunctions and/or damage to speakers or other devices.

Placement

- Using the unit near power amplifiers (or other equipment containing large power transformers) may induce hum. To alleviate the problem, change the orientation of this unit; or move it farther away from the source of interference.
- This device may interfere with radio and television reception. Do not use this device in the vicinity of such receivers.
- Observe the following when using the unit's floppy disk drive. For further details, refer to “Before Using Floppy Disks” (page 5).
 - Do not place the unit near devices that produce a strong magnetic field (e.g., loudspeakers).
 - Install the unit on a solid, level surface.
 - Do not move the unit or subject it to vibration while the drive is operating.
- Do not expose the unit to direct sunlight, place it near devices that radiate heat, leave it inside an enclosed vehicle, or otherwise subject it to temperature extremes. Excessive heat can deform or discolor the unit.

Maintenance

- For everyday cleaning wipe the unit with a soft, dry cloth or one that has been slightly dampened with water. To remove stubborn dirt, use a cloth impregnated with a mild, non-abrasive detergent. Afterwards, be sure to wipe the unit thoroughly with a soft, dry cloth.
- Never use benzine, thinners, alcohol or solvents of any kind, to avoid the possibility of discoloration and/or deformation.

Repairs and Data

- Please be aware that all data contained in the unit's memory may be lost when the unit is sent for repairs. Important data should always be backed up on a floppy disk, or written down on paper (when possible). During repairs, due care is taken to avoid

the loss of data. However, in certain cases (such as when circuitry related to memory itself is out of order), we regret that it may not be possible to restore the data, and Roland assumes no liability concerning such loss of data.

Memory Backup

- This unit contains a battery which powers the unit's memory circuits while the main power is off. When this battery becomes weak, the message shown below will appear in the display. Once you see this message, have the battery replaced with a fresh one as soon as possible to avoid the loss of all data in memory. To have the battery replaced, consult with your retailer, the nearest Roland Service Center, or an authorized Roland distributor, as listed on the “Information” page.

“Battery Low”

Additional Precautions

- Please be aware that the contents of memory can be irretrievably lost as a result of a malfunction, or the improper operation of the unit. To protect yourself against the risk of losing important data, we recommend that you periodically save a backup copy of important data you have stored in the unit's memory on a floppy disk.
- Unfortunately, it may be impossible to restore the contents of data that was stored on a floppy disk, in the unit's memory or another MIDI device (e.g., a sequencer) once it has been lost. Roland Corporation assumes no liability concerning such loss of data.
- Use a reasonable amount of care when using the unit's buttons, sliders, or other controls; and when using its jacks and connectors. Rough handling can lead to malfunctions.
- Never strike or apply strong pressure to the display.
- When connecting / disconnecting all cables, grasp the connector itself—never pull on the cable. This way you will avoid causing shorts, or damage to the cable's internal elements.
- A small amount of heat will radiate from the unit during normal operation.
- To avoid disturbing your neighbors, try to keep the unit's volume at reasonable levels. You may prefer to use headphones, so you do not need to be concerned about those around you (especially when it is late at night).
- When you need to transport the unit, package it in the box (including padding) that it came in, if possible. Otherwise, you will need to use equivalent packaging materials.

-
- Use only the specified expression pedal (EV-5; sold separately). By connecting any other expression pedals, you risk causing malfunction and/or damage to the unit.

Before Using Floppy Disks

Handling the Floppy Disk Drive

- Install the unit on a solid, level surface in an area free from vibration. If the unit must be installed at an angle, be sure the installation does not exceed the permissible range: upward, 5°; downward, 35°.
- Avoid using the unit immediately after it has been moved to a location with a level of humidity that is greatly different than its former location. Rapid changes in the environment can cause condensation to form inside the drive, which will adversely affect the operation of the drive and/or damage floppy disks. When the unit has been moved, allow it to become accustomed to the new environment (allow a few hours) before operating it.
- To insert a disk, push it gently but firmly into the drive—it will click into place. To remove a disk, press the EJECT button firmly. Do not use excessive force to remove a disk which is lodged in the drive.
- Never attempt to remove a floppy disk from the drive while the drive is operating (the indicator is brightly lit); damage could result to both the disk and the drive.
- Remove any disk from the drive before powering up or down.
- To prevent damage to the disk drive's heads, always try to hold the floppy disk in a level position (not tilted in any direction) while inserting it into the drive. Push it in firmly, but gently. Never use excessive force.

Handling Floppy Disks

- Floppy disks contain a plastic disk with a thin coating of magnetic storage medium. Microscopic precision is required to enable storage of large amounts of data on such a small surface area. To preserve their integrity, please observe the following when handling floppy disks:
 - Never touch the magnetic medium inside the disk.
 - Do not use or store floppy disks in dirty or dusty areas.
 - Do not subject floppy disks to temperature extremes (e.g., direct sunlight in an enclosed vehicle). Recommended temperature range: 10 to 50° C (50 to 122° F).
 - Do not expose floppy disks to strong magnetic fields, such as those generated by loudspeakers.

- Floppy disks have a “write protect” tab which can protect the disk from accidental erasure. It is recommended that the tab be kept in the PROTECT position, and moved to the WRITE position only when you wish to write new data onto the disk.

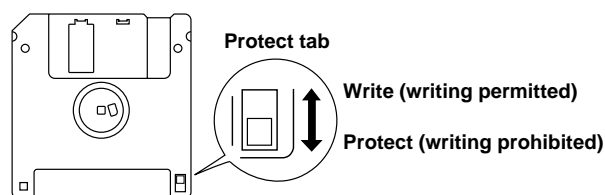

- The identification label should be firmly affixed to the disk. Should the label come loose while the disk is in the drive, it may be difficult to remove the disk.
- Put the disk back into its case for storage.

Handling and Installing the Wave Expansion Board (SR-JV80 series)

- To avoid the risk of damage to internal components that can be caused by static electricity, please carefully observe the following whenever you handle the board.
 - Before you touch the board, always first grasp a metal object (such as a water pipe), so you are sure that any static electricity you might have been carrying has been discharged.
 - When handling the board, grasp it only by its edges. Avoid touching any of the electronic components or connectors.
- Do not touch any of the printed circuit pathways or connection terminals.
- Never use excessive force when installing a circuit board. If it doesn't fit properly on the first attempt, remove the board and try again.
- When circuit board installation is complete, double-check your work.

Features of the XP-60/XP-80

Expandability

Allows four Wave Expansion Boards to be installed at the same time.

The XP-60/XP-80 can take up to four Wave Expansion Boards at one time for complex sounds that use prodigious amounts of waveform data. (p.45)

Standard MIDI File compatibility

The XP-60/XP-80 will play back music data from popular, commercial Standard MIDI File (SMF) music data releases as well as Super-MRC format song data from sequencers. (p.97, 102)

Quick and intuitive operation

Large display

A large display provides at-a-glance indication of all the related parameters. The comprehensive graphic display enables simple editing and onscreen confirming.

Enhanced operational ease

Dedicated buttons are provided for each function to simplify operation. [F1]–[F6] buttons located below the display allow intuitive editing. (p.20)

Multiple outputs

The XP-60/XP-80 is equipped with MIX OUTPUT and DIRECT OUTPUT stereo outputs. Outputs from two independent jacks allow different instrument sounds to be processed individually using external effects units and sophisticated mixing. (p.60, 68)

Click output to external equipment

A set of headphones or amp can be connected to the CLICK OUTPUT jack for audible reference click. (p.180)

High-performance synthesizer sound source

64-voice polyphony and 16-part multitimbrality

The XP-60/XP-80 is a 16-part multitimbral sound source that produces up to 64 simultaneous polyphonic notes. Effectively used with the built-in sequencer or an external computer, the XP-60/XP-80's true creative potential for music production becomes apparent. (p.19)

Powerful onboard effects

Advanced DSP (Digital Signal Processor) technology provides a wide array of studio quality effects. In addition to the multiple effects (EFX) section that features 40 different types of effects, the XP-60/XP-80 also features an independent chorus unit and reverb unit. (p.39)

Extensive Tone structure range

Ten different Structures are available for combining basic sound elements for more flexible sound making. A ring modulator and booster enhance creating sounds. (p.49)

An array of arpeggio and cutting options

With the [ARPEGGIO] on, you can create various arpeggios and simulate cutting techniques simply by pressing a chord. You can even specify the rhythmical 'feel' you want. (p.35)

GM System compatibility

The XP-60/XP-80 provides a mode compatible with the GM System, the standard format for desktop music (DTM) systems, and can play back commercially available GM compatible song data. (p.173)

GM System

GM (General MIDI) is an industry-wide set of specifications for sound sources, which allows music data to be created and played back regardless of manufacturer or specific models. GM compatible song data carries the GM logo () indicating that it will correctly play back on any GM compatible sound source.

Full-fledged sequencer – MRC Pro

Quick Play for immediate song playback

A song from floppy disk can be played back directly without having to load it into internal memory. (p.98)

Non-stop loop recording for smoother song creation without interruptions

While recording, destination phrase tracks can be changed so drum, bass, and melody parts can be recorded in continuous sequence. (p.109)

RPS (Realtime Phrase Sequencing) – a powerful feature for onstage performance

With RPS, your own patterns can be assigned to a key and played back simply by pressing that key. This makes intricate phrases easier to play. (p.150)

Chain Play for continuous playback of specified songs

Chain Play plays back songs on a disk in the sequence you want, convenient when using the XP-60/XP-80's sequencer in performance. (p.153)

Groove Quantize for creating your own groove

Choose your favorite from the 71 groove templates provided. Groove templates can also be customized and 16 of them can be stored in the user area. (p.139, 142)

Preview supports Quantize functions

Preview lets you check out groove variations in real time while setting Quantize parameters. This helps you get the exact result you want with Shuffle Quantize and Groove Quantize. (p.136)

Allows playback in sync with the Roland "VS-880" hard disk recorder

You can synchronize the XP-60/XP-80 to the VS-880 and vice versa, simply by connecting these two devices via a MIDI cable and setting the necessary parameters. This allows you to digitally record a song created on the XP-60/XP-80 along with vocals and live performance on the VS-880. (p.184)

Chapter outlines

For XP-60 Owners

Even though only the XP-80 model is referred to in this manual and in the Quick Start manual, all operations are common to both the XP-80 and XP-60.

Please substitute "XP-60" for each occurrence of "XP-80" that you find in this Owner's Manual and the Quick Start.

This manual is divided into 12 chapters. But before you start reading it, we'd like to suggest going through the Quick Start booklet.

Chapter 1. An overview of the XP-80

This chapter covers XP-80 sound source and sequencer section configurations, as well as basic operation. Please be sure to read this chapter in order to fully understand the XP-80.

Chapter 2. Playing

This chapter explains how to use the XP-80 in Patch, Performance and Rhythm Set modes. Reading it is essential for understanding XP-80 operational procedures.

Chapter 3. Creating your own sounds

This chapter covers creating sounds, the parameters that make up a Patch, Performance, or Rhythm Set, and the System parameters that determine global XP-80 operation, as well as their functions. Comprehending the information in the chapter is an essential prerequisite before creating your own sounds.

Chapter 4. Playing back and recording a song

This chapter is a detailed discussion on playing back and recording a song. Understanding this chapter is essential for correctly operating the XP-80.

Chapter 5. Editing a song

This chapter explains song editing and song settings in detail. It's important to know this material when you wish to edit a pre-recorded song using the Track Edit, Microscope Edit and/or Quantize functions.

Chapter 6. Realtime Phrase Sequencing (RPS)

This chapter covers RPS in some detail, including RPS settings and how to play back a song using the RPS function.

Chapter 7. Playing songs in sequence (Chain Play)

The function that consecutively plays back songs from disk in an order you specify is called 'Chain Play.' This chapter explains Chain Play settings and how to play songs back.

Chapter 8. XP-80 memory settings (Utility mode)

This chapter goes over the various Utility functions such as storing Patch, Performance or Rhythm Set data, clearing the internal memory, etc. Being familiar with these will streamline operation procedures.

Chapter 9. Disk-related functions (Disk mode)

This chapter covers disk-related operations such as saving data to disk, loading data from disk into internal memory, etc.

Chapter 10. Using the XP-80 as the GM sound source

This chapter explains needed procedures and parameters for using the XP-80 as a GM System-compatible sound source. Read this chapter before attempting to play back commercial GM score data.

Chapter 11. Getting the full potential of the XP-80

This chapter includes various techniques that expand the XP-80's operational scope. It includes use with external MIDI devices, live performance applications and others.

Chapter 12. Supplementary material

This chapter contains a troubleshooting section for use when the XP-80 is not functioning as expected. There is also a list of error messages that you can refer to if an error message appears on the display. A list of parameters and MIDI implementation chart are also provided.

Notation used in this Owner's Manual

To make operation procedures easy to understand, the following notation system is adopted:

Characters and numbers in square brackets [] indicate buttons on the front panel. For example, [PATCH] represents the PATCH button and [ENTER] the ENTER button.

An asterisk (*) at the beginning of a paragraph indicates a note or precaution. These should not be ignored.

(p.??) refers to pages within the manual.

Columns marked by include supplementary information regarding functions or tips on operation.

<Procedure> section discusses operational steps that should be read.

(Basic Procedure) section explains basic procedures covering each function. Please read these because they'll make it easier for you later.

(Examples) section provides examples for reference.

Paragraphs that explain parameters are titled "Onscreen abbreviation indication (full name of parameter)."

Examples

RTC 1 (Realtime controller 1)

Through (Thru function switch)

In the text, parameters are referred to as "Channel parameter (PERFORM/MIDI/Part MIDI) for instance. This means the Channel parameter is found in the MIDI Group's Part MIDI display in Performance mode. Display screens will also be referred to in a similar manner; e.g., "Part MIDI display (PERFORM/MIDI)."

Mode	Display group	Display name
PERFORM/MIDI	Part MIDI	1(Koto)
Channel	1	Rx Prog Chg Switch ON
Rx Switch	ON	Rx Volume Switch ON
Tx Switch	ON	Rx Hold-1 Switch ON
Local Switch	ON	Tx Bank Select PATCH
		Tx Volume OFF
Common	K.Range	Part
		MIDI
		Effects
		Palette

For parameters located in the same display, descriptions in parentheses () are omitted; e.g., "Rx Switch parameter."

Display screens

Display screen figures in this manual may sometimes differ from factory settings.

Contents

IMPORTANT NOTES	4
Features of the XP-60/XP-80	6
Chapter outlines	7
Contents	8
Names and functions of buttons and controls	14
Chapter 1. An overview of the XP-80	18
XP-80 configuration	18
Basic configuration	18
Classification of XP-80 sound types	18
Basic operation	20
Switching modes	20
Switching displays	20
Moving the cursor	23
Modifying a value.....	23
Assigning a name	24
Chapter 2. Playing	26
Playing in Patch mode	26
Selecting a Patch.....	26
Displaying a Patch list	27
Making a Patch sound thick or thin (turning a Tone on/off)	27
Playing single notes (Solo)	28
Creating smooth pitch changes (Portamento)	28
Quick sound character changes (Sound Palette)	28
Playing in Performance mode	29
Selecting a Performance	29
Displaying a Performance's Sound List window	29
Playing fatter and richer sounds by combining Patches (Layer)	30
Splitting the keyboard to play separate Patches in different sections (Split)	30
Playing along with a song playback (XP-80 used as a multitimbral sound source).....	31
Assigning a different Patch to a Part	32
Quick sound character changes (Sound Palette)	32
Playing in Rhythm Set mode	33
Selecting a Rhythm Set	33
Displaying Sound List window of a Rhythm Set	34
Playing percussion instruments.....	34
Playing an arpeggio	35
Playing an arpeggio over a preset keyboard area.....	36
Holding an arpeggio	36
Simulating a guitar cutting technique.....	36
Playing an arpeggio from an external MIDI device.....	36
Creating an arpeggio pattern.....	36
Recording an arpeggio	37
Convenient functions for performance	37
Transposing the keyboard in octave units (Octave Shift)	37
Transposing the keyboard in semitone steps (Transpose).....	38
If 'stuck' notes occur or a note does not sound (Panic).....	38

Chapter 3. Creating your own sounds	39
Regarding effects	39
How effects units work in different modes	39
Turning effects on/off	40
Sound editing procedures	40
Editing a Patch	40
Editing a Performance	43
Editing a Rhythm Set	44
Keeping edited sound	45
Memory and data storage	45
Storing a sound you modify into user memory	46
Functions of Patch parameters	46
Settings common to the entire Patch (Common)	46
Modifying waveform and pitch (WG)	51
Modifying the brightness of sound with a filter (TVF)	54
Changing the sound's volume (TVA)	55
Modulating sounds-Adding Vibrato, Tremolo, etc./Using controllers to Change how sounds are played (LFO&Ctl)	57
Setting effects for a Patch (Effects)	60
Functions of Performance parameters	65
Settings common to the entire Performance (Common)	65
Setting the keyboard range (K.Range)	66
Making settings for each Part (Part)	66
Making MIDI settings for a Part (MIDI)	67
Setting effects for a Performance (Effects)	68
Confirming MIDI information for each Part (Info)	69
Functions of Rhythm Set parameters	70
Naming a Rhythm Set (Common)	70
Modifying waveform and pitch of a Rhythm Tone (Key WG)	70
Changing the tone (filter) of a Rhythm Tone (Key TVF)	71
Changing the volume of a Rhythm Tone (Key TVA)	72
Controlling how a Rhythm Tone will sound with controllers (Key Ctl)	72
Setting effects for a Rhythm Tone (Effects)	73
EFX effect types (EFX Parameter)	74
XP-80 operating environment setup (System parameters and their functions)	88
Setups and keyboard settings (Setup)	88
Adjusting tuning (Tune)	89
MIDI settings (MIDI)	90
Assigning sliders, pedals and other controllers (Control)	92
Arpeggio settings (Arpeg)	93
Confirming the XP-80's current conditions (Info)	95



Chapter 4. Playing back and recording a song	96
About the sequencer	96
Songs	96
Track configuration	96
Position for storing a song	96
Playing back a song	97
Playing back a song directly from disk (Quick Play)	98
Fast-forwarding or 'rewinding' a song	98
Resuming playback from the middle of a song (MIDI Update)	99
Programming songs for playback	99
Changing the Part to be played from the keyboard	99
Changing the instrument sounds for song playback	99
Silencing specific instruments 1 (Muting Phrase tracks)	100
Silencing specific instruments 2 (Turning the Receive channel off)	100
Playing back a song with a tempo change	100
Playing back a song with a constant tempo (Muting the Tempo track)	101
Playing back a Pattern	101
Playing back a song created in the S-MRC format	102
Repeatedly playing back a song (Loop Play)	102
Changing sound character during playback	102
Adjusting volume balance between Parts	103
Adjusting panning of each Part	103
Before you start to record	104
Recording process	104
How Phrase tracks, Parts and MIDI channels interact	104
Recording methods	104
Recording destinations of sequencer data	104
Selecting instrument sounds	105
Erasing the song from internal memory	105
Setting the time signature	105
Recording as you play (Realtime recording)	106
Settings for realtime recording	106
Performing realtime recording	108
Recording specific data only (Recording Select)	109
Changing the Phrase track during recording (Non-stop Loop Recording)	109
Checking instrument sounds or phrases during recording (Rehearsal)	109
Deleting unwanted data during recording (Realtime Erase)	110
Recording tempo changes	110
Changing instrument during recording	110
Modifying parameter values of each Part during recording	111
Checking MIDI messages received by each Part during recording	111
Changing the sound character of each Part during recording	111
Recording volume balance between Parts	112
Panning Parts during recording	112
Canceling recording (Undo)	112
Inputting data step by step (Step recording)	113
Inputting notes and rests	113
Assigning a Pattern to a Phrase track	114
Deleting recording (Undo)	115
Saving the recorded song to disk	115
Saving sound data along with a song	115
Saving only a song	116
Saving a song in the Standard MIDI File format	116

Chapter 5. Editing a song.....	117
Sequencer operating environment setup.....	117
Settings for an entire song.....	118
Naming a song (Song Name).....	118
Naming a Pattern (Pattern Name).....	118
Monitoring Phrase track data and settings.....	119
Locate function.....	119
Setting loop.....	120
Editing sequencer data over the specified range (Track Edit).....	121
About Track Edit.....	121
Setting the editing area.....	122
Erasing data input mistakes — 1 Erase.....	123
Deleting unwanted data portions — 2 Delete.....	124
Copying a phrase — 3 Copy.....	124
Inserting blank measures — 4 Insert Meas (Insert measure).....	126
Transposing the pitch — 5 Transpose.....	126
Modifying velocity — 6 Chg Velocity (Change velocity).....	127
Changing MIDI channel — 7 Chg Channel (Change MIDI channel).....	128
Changing note length — 8 Chg Gate Time (Change gate time).....	129
Combining two Phrase Tracks/Patterns into one — 9 Merge.....	130
Extracting and moving a part of sequencer data — 10 Extract.....	131
Shifting sequencer data backward or forward — 11 Shift Clock.....	132
Thinning out sequencer data — 12 Data Thin.....	133
Exchanging Phrase tracks/Patterns — 13 Exchange.....	134
Adjusting the song playback time — 14 Time Fit.....	134
Deleting blank measures — 15 Truncate.....	135
Aligning a song's timing (Quantize).....	136
About quantizing.....	136
Grid quantize.....	137
Shuffle quantize.....	138
Groove quantize.....	139
Editing sequencer data one at a time (Microscope Edit).....	144
Viewing the Microscope display.....	144
Viewing only specific sequencer data.....	146
Modifying sequencer data recorded in a Phrase track/Pattern.....	146
Modifying tempo change recorded on the Tempo track.....	147
Modifying data recorded on the Beat track.....	147
Setting the time signature of a Pattern.....	147
Inserting new sequencer data into a Phrase track/Pattern.....	147
Changing the tempo during a song.....	148
Changing the time signature during a song.....	148
Erasing sequencer data.....	149
Moving sequencer data.....	149
Copying sequencer data.....	149
Chapter 6. Realtime Phrase Sequencing (RPS).....	150
Getting ready to use RPS.....	150
RPS parameters.....	150
Playing using RPS.....	151
Playing a Pattern from a external MIDI keyboard using RPS.....	151
Recording performance using RPS.....	151

Chapter 7. Playing songs in sequence (Chain Play)	153
Getting ready for Chain Play	153
Saving a chain to disk.....	154
Chain play	154
Chapter 8. XP-80 memory settings (Utility mode)	155
About Utility mode	155
Storing sound data in user memory — 1 Write	156
Performance write	156
Patch write.....	156
Rhythm Set write	156
Copying sound source settings — 2 Copy	157
Performance copy	157
Patch copy.....	158
Rhythm Set copy	159
Initializing sound source settings — 3 Initialize	160
Performance initialize	160
Patch initialize.....	160
Rhythm Set initialize	160
Transmitting sound settings — 4 Data Transfer	161
Transmitting data to an external MIDI device.....	161
Transmitting data to the internal song	161
Transmitting data to user memory.....	162
Preventing user memory writing operation — 5 Protect (User memory protect)	164
Erasing the internal song — 6 Song Init (Song initialize)	164
Checking internal memory consumption — 7 Memory Info (Internal memory information)	164
Recalling factory default settings — 8 Factory (Factory preset)	165
Chapter 9. Disk-related functions (Disk mode)	166
About Disk mode	166
Loading a file from disk into the XP-80 — 1 Load	167
Saving data to disk — 2 Save	168
Formatting the disk for the XP-60/XP-80 — 3 Format	169
Making a copy of a disk — 4 Backup	170
Checking files recorded on disk — 5 Verify	170
Changing the name of disk — 6 Volume (Change volume label)	170
Deleting unwanted files — 7 Delete (Delete file)	171
Renaming a file — 8 Rename	171
Checking the contents of disk — 9 Info (Disk information)	172
Chapter 10. Using the XP-80 as the GM sound source	173
Entering GM mode	173
Initializing the sound source for GM System basic settings	173
Playing back a GM score.....	173
Modifying GM mode settings	174
Setting a Part (Part).....	174
Making effects settings in GM mode (Effects)	174
Confirming MIDI information of each Part (Info).....	175

Convenient functions in GM mode (GM Utility)	176
Copying effects settings — 2 Copy (GM Copy)	176
Initializing GM mode — 3 Initialize (GM Initialize)	176
Transmitting GM mode settings — 4 Data Transfer (GM Data Transfer)	177
Chapter 11. Getting the full potential of the XP-80	178
Techniques for using Patches	178
Reinforcing filter characteristics	178
Making the up-beat note sound at the same time you play a down-beat note	178
Holding a note with modulation retained	178
Syncing the LFO cycle to sequencer tempo	178
Modifying EFX to match the tempo of a song	178
Using a pedal switch to modify the rotary speed of the Rotary effect	179
Playing phrase loops at a song's tempo	179
Using the C1 slider to pan sounds in real time	179
Using the XP-80 to play live	179
Changing multiple sounds of an external MIDI device simultaneously	179
Changing sounds with a pedal switch	180
Using a pedal switch to start and stop playback	180
Matching the song's playback tempo with the tempo of the band that's playing	180
Playing a drum referring to a XP-80 click	180
Song making techniques	180
Recording a song with a consistent volume level regardless of keyboard playing dynamics	180
Having a song fade in or out	180
Changing a sound during a song	181
Avoiding sound dropouts in a song	182
Using external MIDI devices	182
Using the XP-80 to change the sound on an external MIDI device	182
Using the XP-80 to control external MIDI devices	182
Playing the XP-80 sound source from an external MIDI device	183
Synchronization with external MIDI devices	183
Syncing an external sequencer to the XP-80's sequencer	183
Syncing the XP-80's sequencer to an external sequencer	183
Recording a song from an external sequencer into the XP-80's sequencer	183
Synchronizing to the VS-880 Hard Disk Recorder	184
Getting ready to sync to the VS-880	184
Playing back Song files	185
Recording on the VS-880	185
Recording on the XP-80	186
Chapter 12. Supplementary material	187
Troubleshooting	187
Error messages	188
Parameter list	190
Factory preset settings	206
Arpeggio style list	213
MIDI implementation	214
Specifications	231
Quick reference of displays	232
Index	241

Names and functions of buttons and controls

Front panel

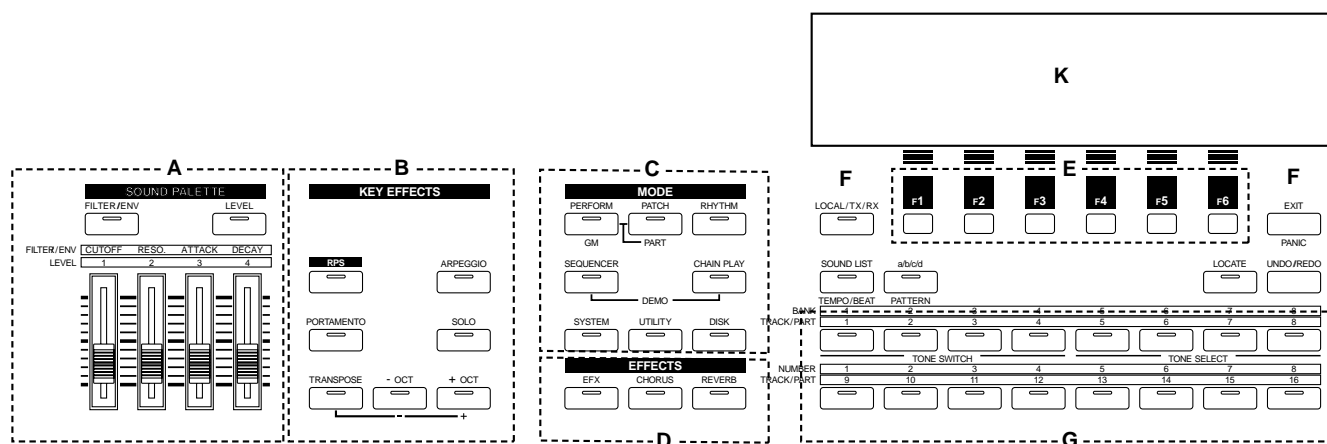

A. SOUND PALETTE section

Use the four sliders to modify sounds in real time.

[FILTER/ENV]

Press this button ON when modifying filter and/or envelope settings in real time using the four sliders (p.28, 32).

[LEVEL]

Press this button ON when adjusting volume balance in real time using the four sliders (p.28, 32).

B. KEY EFFECTS section

The buttons in this section allow you to assign various functions to the keys of the XP-80's keyboard.

[RPS]

Switches RPS on/off (p.151).

[ARPEGGIO]

Switches Arpeggiator on/off (p.35).

[PORTAMENTO]

Switches Portamento on/off (p.28).

[SOLO]

Specifies playing a single note at a time (p.28).

[TRANSCOPE]

Specifies transposing the keyboard in semitone steps (p.38).

[+OCT], [-OCT]

These buttons adjust the pitch of the keyboard in octave steps (p.37).

Pressing either of these buttons while holding down [TRANSCOPE] allows you to set the desired amount of transposition (p.38).

C. MODE section

The buttons in this section select modes. The button indicator of the selected mode will light (p.20).

D. EFFECTS section

The buttons in this section turn their respective internal effects (EFX, Chorus and Reverb) on/off.

[EFX]

Switches the multiple effects unit (EFX) on/off (p.40).

[CHORUS]

Switches Chorus on/off (p.40).

[REVERB]

Switches Reverb on/off (p.40).

E. [F1]–[F6] (Function buttons)

Each of these buttons corresponds to a function indicated at the display bottom. The functions of these buttons change depending on the selected mode or the current display (p.20).

F.

[LOCAL/TX/RX]

This button opens the LOCAL/TX/RX window for switching Local, Transmit and Receive switches on/off (p.30).

[EXIT] / [PANIC]

The function of this button changes depending on whether you hold down [SHIFT] or not.

EXIT: Press this button to return to the Play display of a mode (p.21), or when you want to cancel the current operation.

PANIC: If notes stick or do not sound, hold down [SHIFT] and press this (p.38).

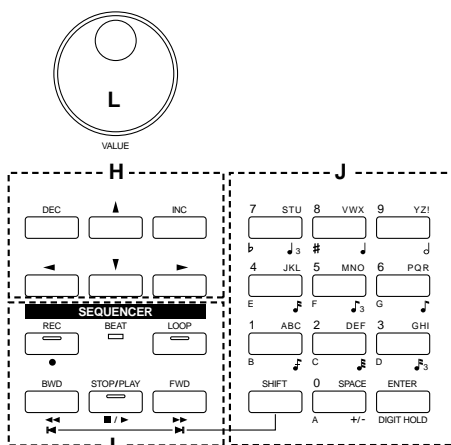

[SOUND LIST] / [TEMPO/BEAT]

The function of this button changes depending on the selected mode.

SOUND LIST: Opens the Sound List window when a sound source mode display is up (p.27, 29, 34).

TEMPO/BEAT: Press this button for selecting a tempo track or beat track when a Sequencer mode display is up. If you have temporarily modified the tempo and wish to play back the song with its initial tempo, press it while holding down [SHIFT] (p.100).

[a/b/c/d] / [PATTERN]

The function of this button changes depending on the mode on display.

a/b/c/d: Select a subgroup (a/b/c/d) when selecting a Patch/Performance/Rhythm Set using the Bank/Number method (p.26, 29, 33).

PATTERN: Select a Pattern when a Sequencer mode display is up.

[LOCATE]

This button opens the Locate window to specify and move the locate position (p.119).

[UNDO/REDO]

Press this button to restore a modified value to its previous (pre-modified) state, or when cancelling recording or a currently executing operation. Pressing this button again will restart the recording/operation (p.24).

G.

BANK [1]–[8], NUMBER [1]–[8] / TRACK / PART [1]–[16]

The functions of these buttons change depending on the display which is showing.

Play display of a sound source mode: Selects a

Patch/Performance/Rhythm Set with the Bank /Number method. Use BANK [1]–[8] buttons to select a bank and NUMBER [1]–[8] buttons to select a number (p.26, 29, 33).

Performance edit display: Use TRACK/PART [1]–[16] buttons to select the Part to be modified (p.43).

Patch edit display: TRACK/PART [1]–[4] buttons (TONE SWITCH) are used to switch a Tone on/off (p.27). Use TRACK/PART [5]–[8] buttons (TONE SELECT) to select the Tone to be modified (p.40).

Rhythm Set edit display: Use TRACK/PART [5]–[8] buttons (TONE SELECT) to select the note of the keyboard to be modified (p.44).

Sequencer mode: Use TRACK/PART [1]–[16] buttons to select a phrase track or Part (p.108). During song playback/recording, these buttons can be used to switch between the Play and Mute of a phrase track (p.100).

H.

[◀], [▶], [▲], [▼] (Cursor buttons)

Move the cursor (black box) with these (p.23).

[INC], [DEC]

Use these buttons to modify values. If you keep on holding down one button and pressing the other, the value change accelerates. If you press one of these buttons while holding down [SHIFT], the value will change in bigger increments (p.23).

I. SEQUENCER section

The buttons in this section are used for playback and recording of the XP-80's sequencer.

[REC]

Press this to begin recording (p.106, 113).

BEAT indicator

This blinks in sync with the tempo and beat of the song.

[LOOP]

Press this to turn Loop Play and Loop Recording on/off (p.102).

[BWD]

Press this to “rewind” a song. Pressing this button while holding down [SHIFT] moves you right back to the beginning of the song. If you hold down this button as you press [FWD], the song will “rewind” faster (p.98).

[STOP/PLAY]

Press this button to start or stop playback of the song.

[FWD]

Use this button to fast-forward the song. Pressing this button while holding down [SHIFT] moves you to the end of the song. If you hold down this button as you press [BWD], the song will fast-forward faster (p.98).

J.**[0]–[9] (Numeric keys)**

Use these to set a value. They can be used to enter numeric values as well as alphabetical characters and notes (p.23).

[SHIFT]

This is used in combination with other buttons. Some buttons on the front panel include grey-printed characters. They indicate the button's function when [SHIFT] is held down.

[ENTER] / [DIGIT HOLD]

The function of this button changes depending on whether [SHIFT] is being held down or not.

ENTER: Use this button to finalize a value (p.23).

DIGIT HOLD: Press this button while holding down [SHIFT] to turn the Digit Hold function on/off. With the Digit Hold on, the 100's place and 10's place will be fixed and only the 1's place will change. This means that you can select Patches simply by pressing the numeric key for the 1's place, without having to press [ENTER] (p.27).

K.**Display**

Shows various information for the currently selected function or operation.

L.**VALUE dial**

This dial is used to modify values. If you hold down [SHIFT] as you turn the VALUE dial, the value will change in greater increments (p.23).

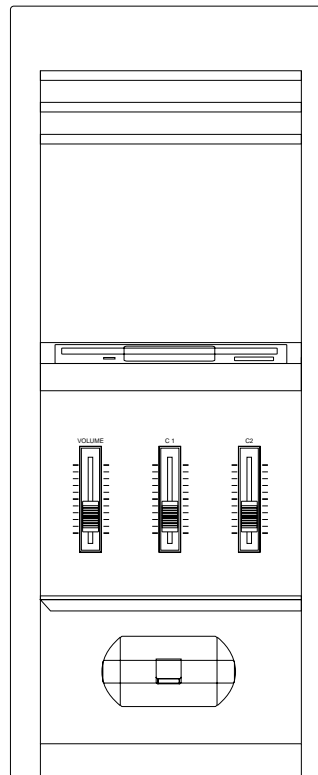
Side panel**VOLUME slider**

This slider adjusts the overall output level from the rear panel OUTPUT and PHONES jacks.

C1 slider, C2 slider

Various parameters or functions can be assigned to these sliders, so you can control the sound source section as you play (p.92).

Pitch bend / modulation lever

This allows you to control pitch bend or apply vibrato. Depending on the settings, other specified parameters can also be controlled.

Floppy disk drive

3.5" 2DD/2HD floppy disks can be used. Press the eject switch located at the lower right of the disk drive to remove a disk.

Rear panel

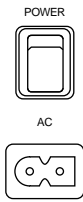

Power switch

Press to turn the power on/off.

AC inlet

Connect the AC power cable (included) to this inlet.

* With units rated for 117V operation, the AC cable is already connected to the unit.



CONTROL PEDAL 1–4 jacks

You can connect the expression pedals (EV-5; sold separately) to these jacks. By assigning a desired function to a pedal, you can use it to select or modify sound or perform various other control. You can also connect optional pedal switches to sustain sound (p.92).

HOLD jack

An optional pedal switch can be connected to this jack for use as a hold pedal.

MIDI connectors

These connectors can be connected to other MIDI devices to receive and transmit MIDI messages.

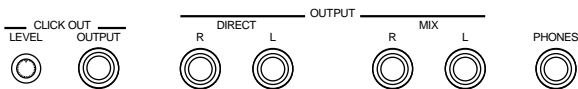

CLICK OUT LEVEL knob

Adjusts the level of the click sound to be output to external devices (p.180).

CLICK OUT OUTPUT jack

Connect a cable to this jack when sending clicks to external devices (p.180).

OUTPUT DIRECT R jack, OUTPUT DIRECT L jack

These jacks output only the direct sound (no effects applied) or EFX'd sound in stereo.

OUTPUT MIX R jack, OUTPUT MIX L jack

These jacks output the audio signal to the connected mixer/amplifier system in stereo. For mono output, use the L jack.

PHONES jack

An optional set of headphones can be connected to this jack. Make sure that your headphones have an impedance of 8–150 ohms.

Chapter 1. An overview of the XP-80

XP-80 configuration

Basic configuration

The XP-80 consists of a sound source, a sequencer and controllers.

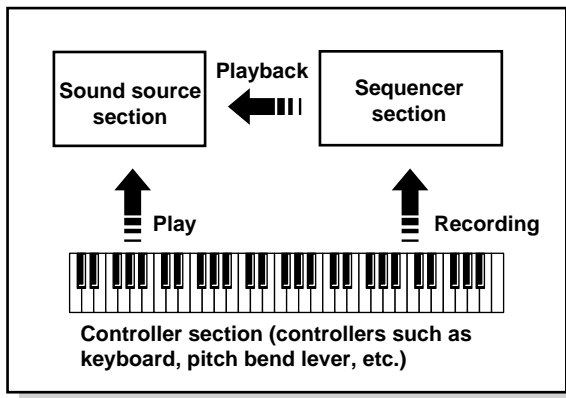

Sound source

The XP-80 sound source produces sound by responding to commands in the form of MIDI messages received from its controllers and sequencer. It will also produce sound by responding to commands received from various external devices it can be connected to.

Sequencer

The sequencer records various controller operations as MIDI messages and transmits them to the sound source. MIDI messages recorded on the sequencer can also be transmitted from the MIDI OUT connector to allow the XP-80 to also control external MIDI devices.

Controllers

Controllers include the keyboard, front panel sliders and pedals which are connected to their respective rear panel jacks. Adjusting these controllers enable you to produce or modify sound.

Classification of XP-80 sound types

XP-80 sounds are made up of the following types:

Tones

In the XP-80, the Tone is the smallest class of sound. Each Tone consists of one sound. But when you play the XP-80 you will mostly play a Patch, which is made up of several Tones. Tones therefore are the elements which collectively form a Patch.

Tone configuration:

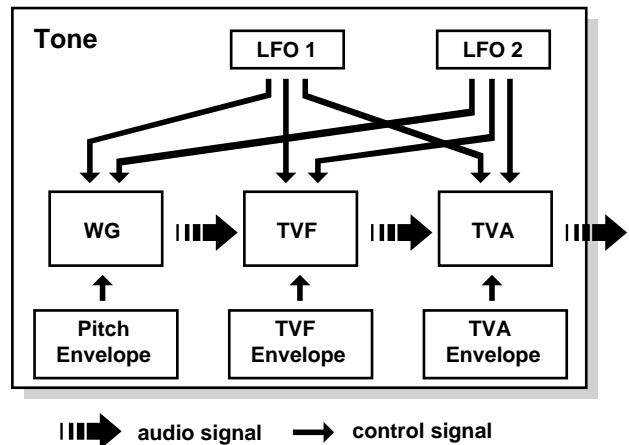

WG (Wave Generator)

Using the Wave Generator, you select a waveform and set its pitch.

TVF (Time Variant Filter)

With the Time Variant Filter, you modify the waveform's frequency characteristics.

TVA (Time Variant Amplifier)

With the Time Variant Amplifier, you set volume level and set the sound's position in a stereo soundfield.

Envelope

You use Envelope to initiate changes to occur to a sound over time. There are separate Envelopes for the WG (pitch), TVF (filter) and TVA (volume). For example, to modify a sound's attack and decay time, you would use TVA Envelope to adjust volume changes to the sound over time.

LFO (Low Frequency Oscillator)

Use the LFO to create cyclic changes (modulation) in a sound. The XP-80 has two LFOs. Either one or both can be applied to effect the WG (pitch), TVF (filter) and/or TVA (volume). To illustrate this control's action, you can apply an LFO to modify the WG (pitch) to create vibrato. If the LFO is used to modify the TVA (volume), you'll get tremolo.

Patches

Patches are the basic sound configurations that you play during a performance. Each Patch can be configured by combining up to four Tones. How the four Tones are combined is determined on the Structure display (Patch/Common).

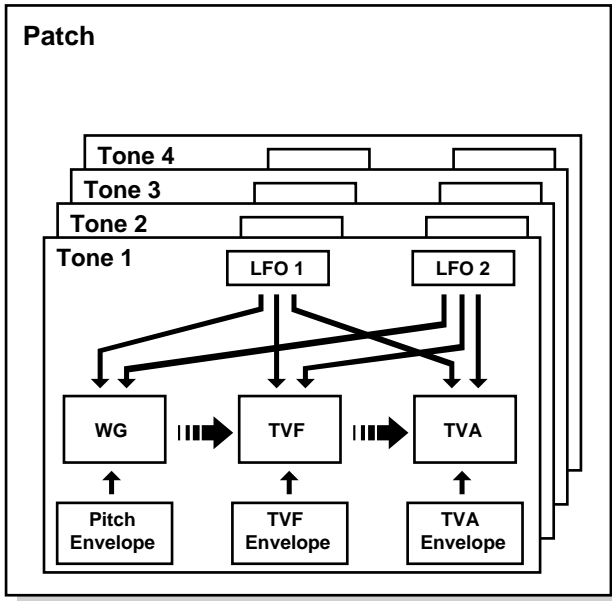

Rhythm Sets

A Rhythm Set is a grouping of percussion instruments (Rhythm Tones). Since percussion instruments generally do not play melodies, there is no need for a percussion instrument sound to be able to play a scale on the keyboard. It is however, more important that as many as possible percussion instruments be available to you at the same time. Therefore, each key (Note number) of a Rhythm Set will produce a different percussion instrument.

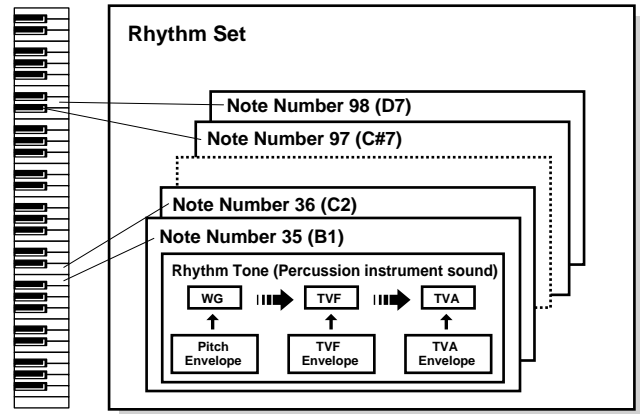

Performances

The next level in sound configuration. A single Performance groups 15 Patches and one Rhythm Set so that they can be combined to play ensembles or produce fabulously rich, thick sounds. One Performance allows a single XP-80 to control up to 16 instrument sounds. Because the XP-80 sound source can control multiple sounds (instruments) it is called a 'multitimbral sound source.'

Parts

When the XP-80 is used as a multitimbral sound source, another sound configuration called a Part comes into play. A Part contains a Patch or Rhythm Set. For multitimbral applications, the Performance consists of 16 Parts. A specific Patch can be assigned to each Part except Part 10 because Part 10 is universally set as the Drum Part to which a Rhythm Set (discussed above) is assigned. In a multitimbral context, it helps to think of a Performance as an orchestra, each Part in it being a musician, and the Patch or Rhythm Set that musician's instrument.

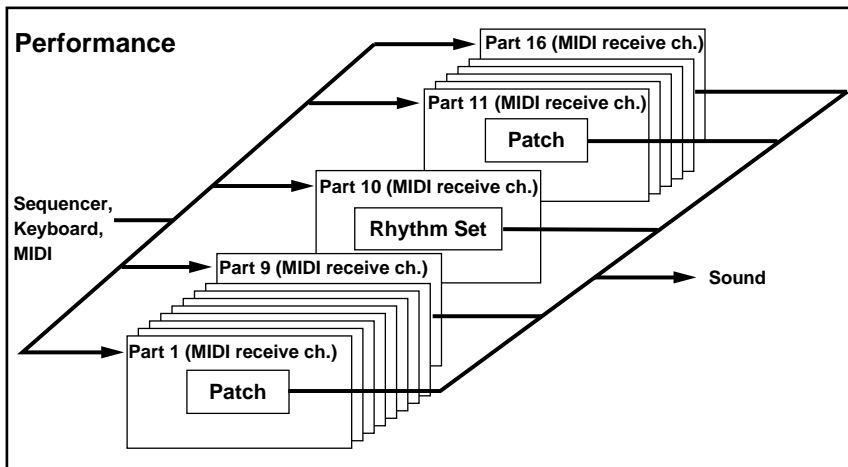

For details regarding following items, please refer to each corresponding page.

- About the Memory (p. 45)
- About the Effects (p. 39)
- About the Sequencer (p. 96)
- About the Song (p. 97)

Basic operation

Switching modes

The XP-80 has enough functions to bewilder you. To make it easy to access the functions you need for specific applications, they're grouped into modes. The mode you've selected determines how the sound source operates and what the display shows. Select a Mode button. It will light and the Play display of that selected mode will appear.

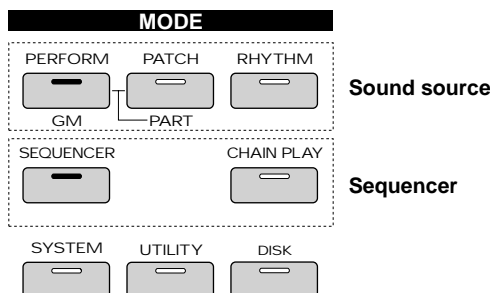

Sound source

Selecting Patch mode, Performance mode, Rhythm Set mode, and GM mode will determine sound source operation. One mode always has to be selected.

Patch mode

In this mode, you can play an individual Patch from the keyboard or modify Patch settings. If you're using an external MIDI device to control the XP-80 in this mode, it will function as a single-patch sound source.

Performance mode

This mode makes the XP-80 function as a multitimbral sound source, and Performance settings can be modified. If you're using an external MIDI device to control the XP-80 in this mode, it will function as a multitimbral sound source.

To modify the settings of a Patch that's assigned to a Part, hold down [PERFORM] and press [PATCH]. Both button indicators will light.

Rhythm Set mode

This is how you can play a Rhythm Set from the keyboard and modify the Rhythm Set settings. In this mode, the keyboard will play the Rhythm Set, but the XP-80 continues to function as a multitimbral sound source. So your effects settings of the currently selected Performance will be heard as you play the Rhythm Set. Rhythm Sets are assigned to Part 10 of the Performance. If you're using an external MIDI device to control the XP-80 in this mode, it will still function as a multitimbral sound source.

GM mode

This special mode makes the XP-80 function as a GM compatible sound source. You should select this mode when you want to play back a GM score (music data created for GM sound source).

To set GM mode, hold down [SHIFT] and press [PERFORM]. [PERFORM], [PATCH] and [RHYTHM] indicators will not light.

Sequencer

Selecting Sequencer mode and Chain Play mode determines how the sequencer will operate. One or the other of these modes has to be selected for the sequencer to operate.

Sequencer mode

For recording, playing back and editing a song.

Chain Play mode

This allows you to select the order of how you want songs to play back.

System mode

This mode is for determining global XP-80 settings such as tuning, display contrast and how MIDI messages are received.

- * Some System mode parameters relate to an entire Patch or an entire Performance. To set these parameters, press [SYSTEM] in the selected mode (Patch or Performance).

Utility mode

The mode for saving and transmitting sound source settings.

- * Some Utility mode parameters relate to an entire Patch, Performance or Rhythm Set. To set these parameters, press [UTILITY] in the selected mode (Patch, Performance or Rhythm Set).

Disk mode

For saving/loading data to/from the internal Floppy Disk.

Switching displays

Displays are grouped by mode. The bottom line displays functions corresponding to [F1]-[F6] (function buttons). Press the corresponding function button to call up the desired display.

Mode	Display group	Display name
PERFORM/Part	Part Param	1(Koto)
Patch Group	GM	Coarse Tune +12
Patch Number	108	Fine Tune 0
Part Level	Koto	Octave Shift 0
Part Pan	97	Voice Reserve(rest 0) 24
	L20	
Common K.Range Part MIDI Effects Palette		
F1	F2	F3
F4	F5	F6
Function Name		

<Procedure>

- On the Play display of a selected mode (Menu display will appear for Disk mode and Utility mode), press a function button to choose a display group.

One of the selected group's display pages will appear.

- * The number of display pages varies by group.

② Press the respective function button to call up a desired display page.

When a function button is pressed, the highlighting of the function name will disappear.

* When a function name is boxed, without being highlighted, it means that special functions like GoTo another display page or an operation execute has been assigned to that function button.

* Data may require two or more display pages if it cannot all be shown on a single page. In that case, the index mark indicating the total number of display pages and the current display page appears to the left of the function name. Repeat-pressing the function button will allow you to move to the other display pages.

* To return to the home Play display, press [EXIT].

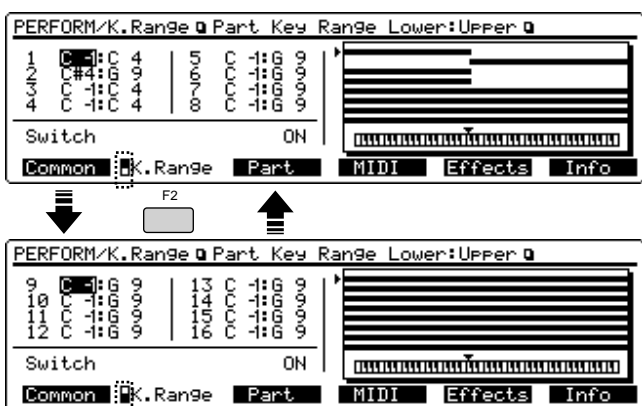

Index mark

Displays are divided into groups for each mode:

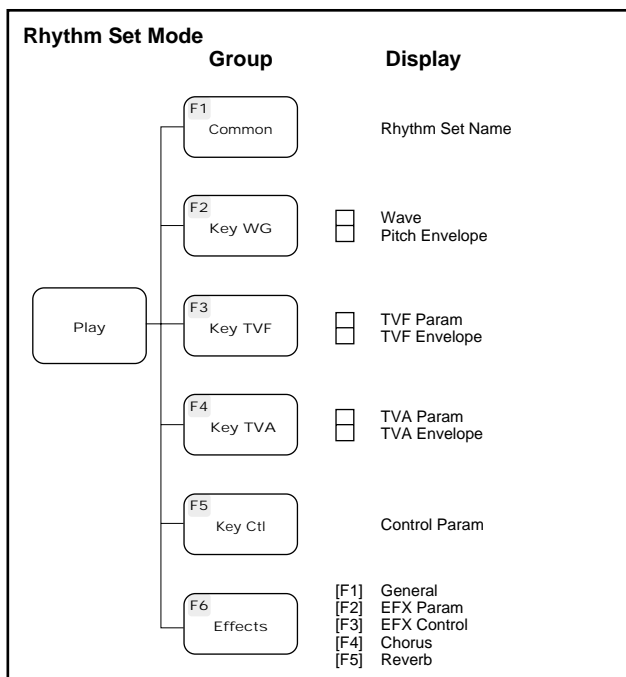
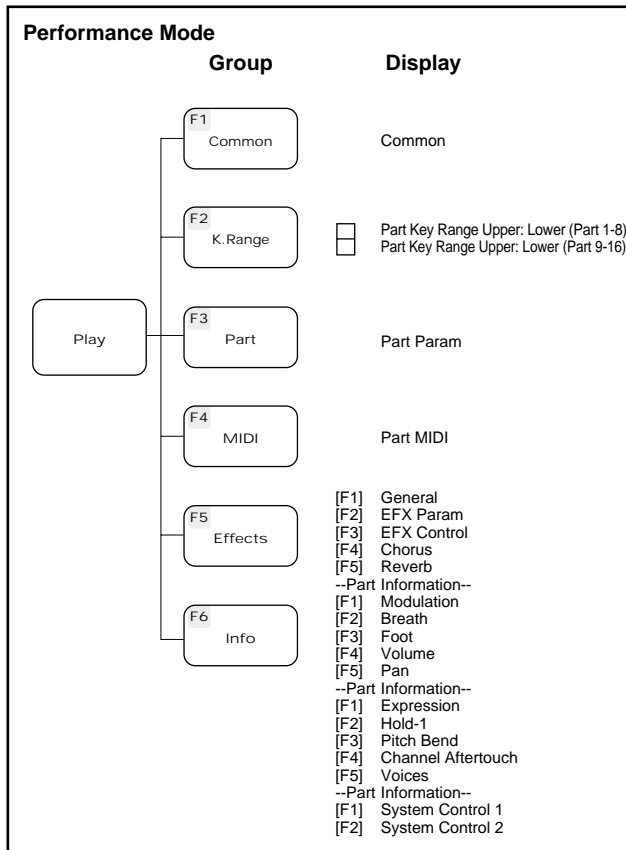
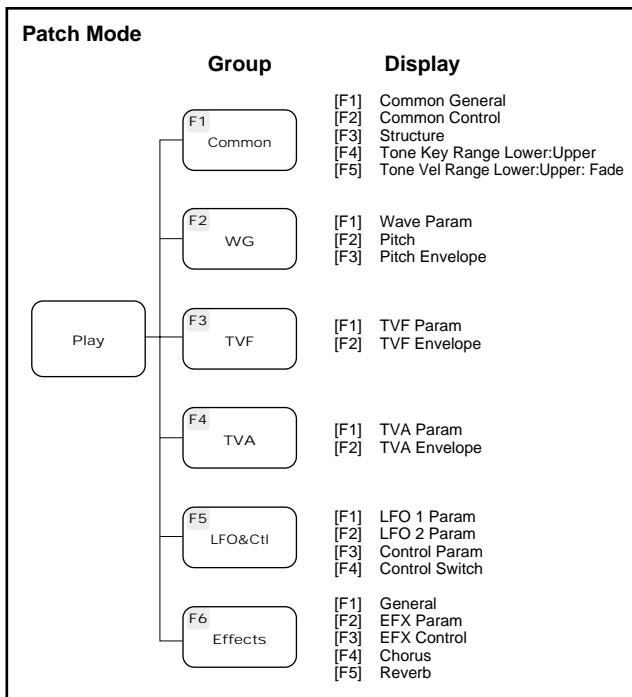

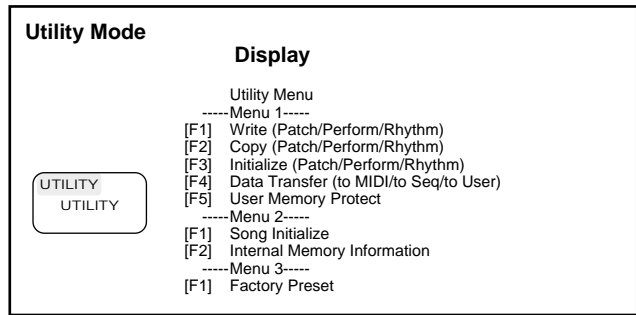
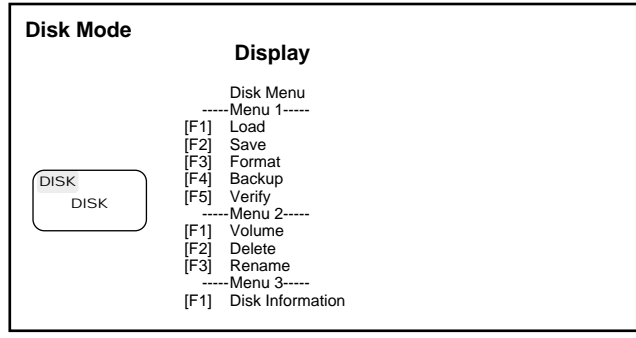
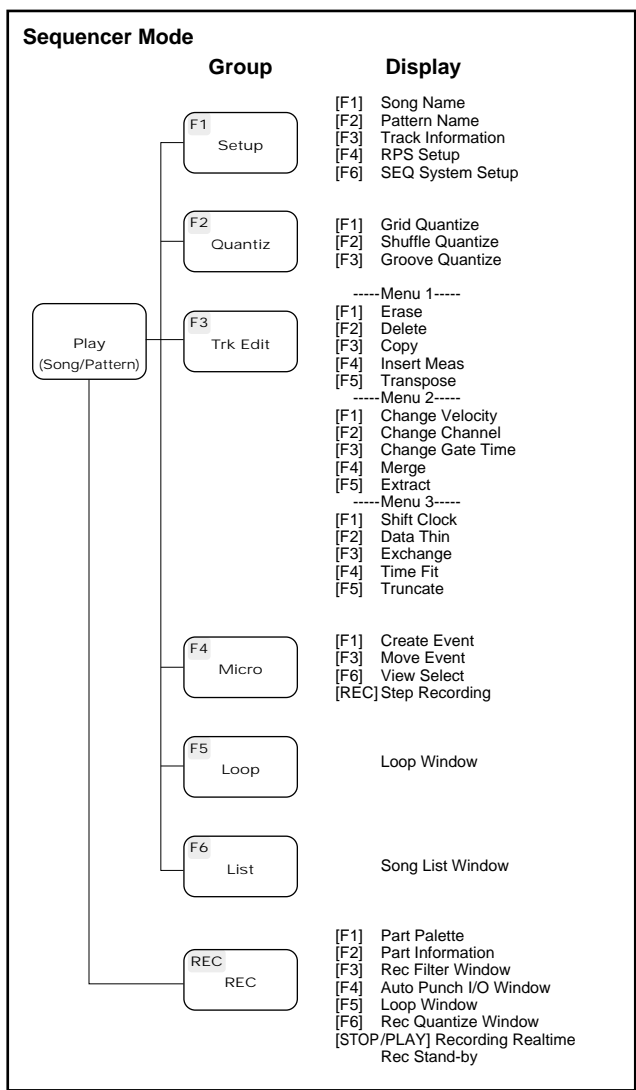
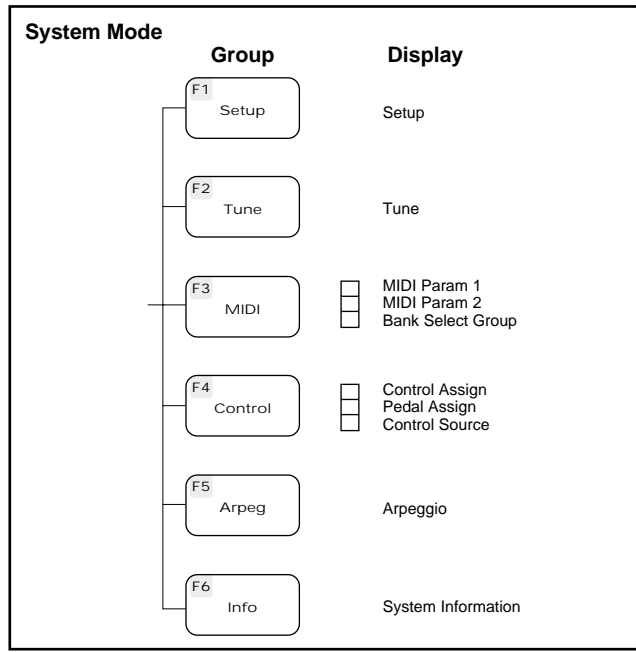
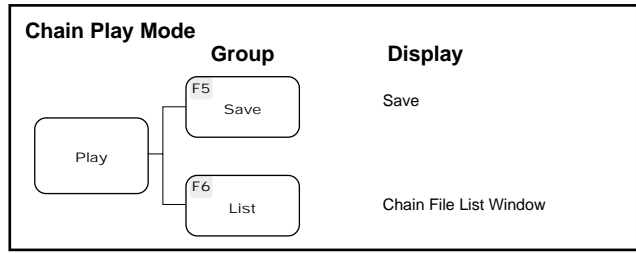
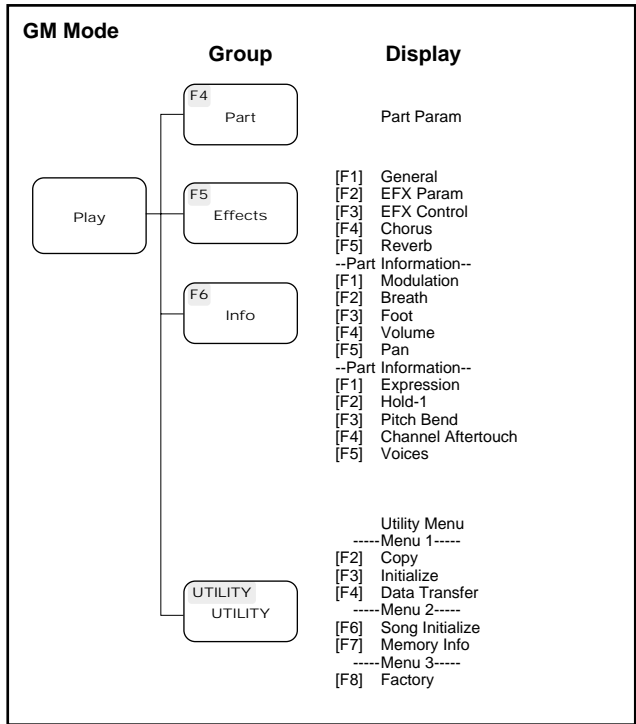

.....
 <Windows>

To assist you, a small window box may appear. It can indicate a list, confirm operation, or help input procedure depending on the situation.



Window

Windows can be opened with their respective buttons and closed by pressing [EXIT] or the button you used to open it. Some windows will close automatically after a pertinent operation is executed.

Moving the cursor

Generally a single display page indicates two or more items (parameters). Move the cursor (black box with value highlighted) to the parameter whose value you want to set or modify. Move the cursor with the [▲], [▼], [◀] and [▶] (cursor buttons).

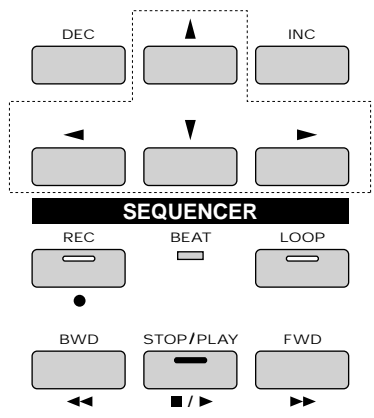

[▲]: moves the cursor up.

Pressing this button when the cursor is at the upper left parameter (home position) shifts it to the lower right parameter.

[▼]: moves the cursor down.

Pressing this button when the cursor is at the lower right parameter shifts it to the upper left parameter (home position).

[◀]: moves the cursor to the left.

Holding down [SHIFT] while you press this button shifts the cursor back to home.

[▶]: moves the cursor to the right.

* If the value of the parameter has not been finalized, the value on which cursor is positioned is only boxed without highlighting. Press [ENTER] to finalize the value and return to the normal display.

Modifying a value

To modify a value, use the VALUE dial, [INC]/[DEC] or [0]–[9] (numeric keys).

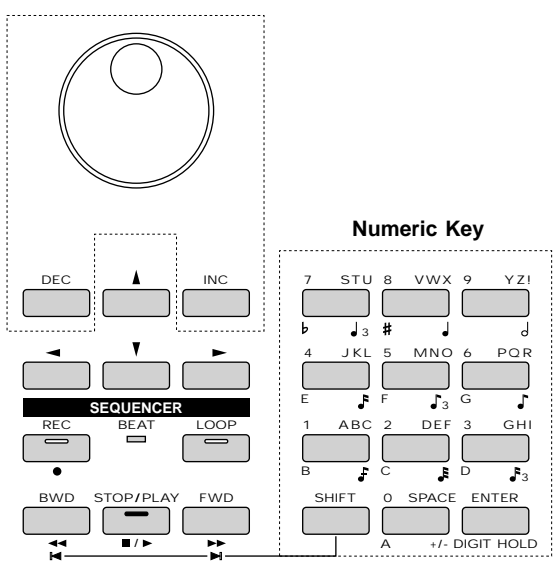

* Each parameter has a specific range, so you cannot set any value smaller than the minimum value or greater than the maximum value.

VALUE dial

Turning the VALUE dial clockwise increases the value, counterclockwise decreases the value. Holding down [SHIFT] as you move the VALUE dial increases value increments so you can make large value changes faster.

[INC] and [DEC]

Pressing [INC] increases the value, and [DEC] decreases it. Keep [INC] or [DEC] pressed for continuous adjustment. For faster value increases, keep [INC] pressed down and press [DEC]. For decreasing value faster, keep [DEC] pressed down and press [INC].

If you press [INC] or [DEC] while holding down [SHIFT], the value increments will get bigger.

[0]–[9] (Numeric Keys)

[0]–[9] are called 'numeric keys' and are for directly specifying numerical values. When you enter a number using the numeric keys, the cursor will change from a black box to a white box, and the highlight of the value will be removed. Now finalize the value by pressing [ENTER].

To go from a positive to negative value (+/-), or vice versa, hold down [SHIFT] and press [0].

* Some parameters do not require you to [ENTER] them.

(Example)

<To enter a value of 38>

Press [3] → press [8] → press [ENTER].

<To enter a value of -60>

While holding down [SHIFT] press [0] → press [6] → press [ENTER].

* You can switch from a positive to negative numerical value anytime before you press [ENTER].

Special functions of the numeric keys

You can use the numeric keys to specify non-numerical settings for some parameters.

Performance/Patch/Rhythm Set group

On the Play displays for Performance, Patch or Rhythm Set mode, you can hold down [SHIFT] and press numeric keys to specify groups.

Buttons	Group
SHIFT+0	USER
SHIFT+1	PR-A (Preset A)
SHIFT+2	PR-B (Preset B)
SHIFT+3	PR-C (Preset C)
SHIFT+4	GM (General MIDI)
SHIFT+5	XP-A (Wave Expansion Board installed in EXP-A Slot)
SHIFT+6	XP-B (Wave Expansion Board installed in EXP-B Slot)
SHIFT+7	XP-C (Wave Expansion Board installed in EXP-C Slot)
SHIFT+8	XP-D (Wave Expansion Board installed in EXP-D Slot)

* This procedure also applies when editing Performances, Patches or Rhythm Sets, and for Utility mode.

Note name

To enter a note name in Track editing mode or Microscope editing mode, hold down [SHIFT] and press the appropriate numeric key. The corresponding note name is at the lower left of each numeric key.

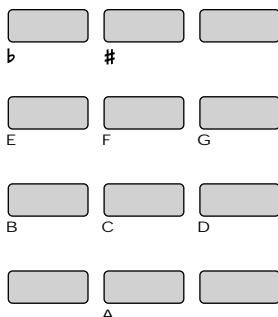

Note value

Use numeric keys to specify a note value in step recording, etc. The corresponding note value is at the lower right of each numeric key.

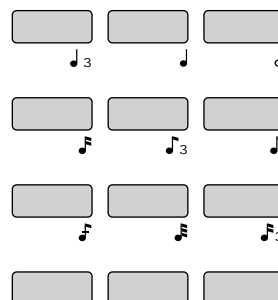

Characters

When assigning a name for Patches, Performances, files and songs, you can use the numeric keys to specify alphabetic characters.

* For details, refer to "Assigning a name" below.

Restoring a previous value (Undo)

If you wish to restore a value to its immediate previous value, press [UNDO/REDO] to return the value to its pre-modified state.

The Undo function can be used when modifying sound source settings, recording a song, editing a song, etc.

* If you are in the middle of an operation that requires rewriting large amounts of data (such as song editing), a message window will show "Memory is low!! So you cannot undo. Execute anyway?" If you are sure you won't have to undo the current operation, press [F5] (OK). Pressing [F6] (Cancel) cancels the operation.

Assigning a name

The XP-80 allows you to assign a name to data types such as: Patch, Performance, Rhythm Set, Song, Pattern, Song File, Chain File, Data File, User Groove Template File, Standard MIDI File, Volume Label

The procedure is the same for each data type.

<Procedure>

- 1 Move the cursor to where you want to input a character.
- 2 Turn the VALUE dial, or press [INC]/[DEC] to specify the character.

Available characters/symbols are:

space, A-Z, a-z, 0-9, +-*|=!/?<>()[]{};:, ""`#%&\$\@^_

Lowercase characters and some symbols (+*|=!/?<>[];:, ""\) cannot be used for filenames and volume labels.

* You can also use numeric keys to select alphabet or numeric characters.

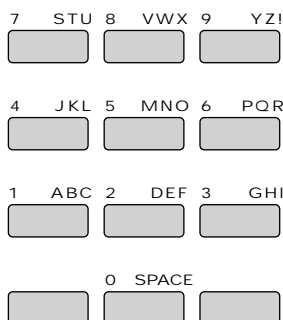

Each time you press a numeric key, the display will cycle through the characters and numerals printed above each key. For instance, pressing [1] will make the display change 1→A→B→C→1→A... To specify lowercase characters, hold down [SHIFT] and press the numeric key.

- ④ Repeat steps 1 and 2 as necessary.
- * If you enter a space in filenames or volume labels, it will be replaced with an underline “_” after the operation is executed. However, a blank entered at the end of a name will be left as a blank.

Assigning a name using a Name window

You can use a Name window to assign a name. As the Name window displays a list of characters that can be entered, you can quickly select a desired character.

<Procedure>

- ① From any display in which you can assign a name, press the following buttons to open a Name window.

Name	Button
Patch	[F1] (General)
Performance	[F1] (Common)
Rhythm Set	[F1] (Common)
Song	[F1] (SngName)
Pattern	[F2] (PtnName)
Filenames and volume labels	[F1] (Name)

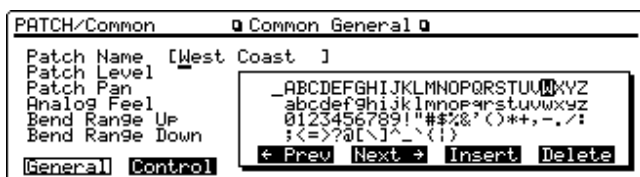

- ② Press [F3] (←Prev) or [F4] (Next→) to move the cursor to the location where you wish to input a character.
- ③ Press cursor buttons or [INC]/[DEC], or turn the VALUE dial to specify the character.

To enter a space at the cursor position, press [F5] (Insert).

To delete the character at the cursor position, press [F6] (Delete).

- ④ Repeat steps 2 and 3 as necessary.
- ⑤ After assigning a name, press [EXIT] or the button you used to open the Name window to close it.

Chapter 2. Playing

Playing in Patch mode

Patches are what you normally play during a performance. Select a Patch before playing.

Selecting a Patch

The XP-80 offers five groups of Patches (User, Presets A–C and GM) with each group having 128 Patches for a total of 640 Patches.

Up to four optional Wave Expansion Boards can be installed to provide a whopping 1,660 Patches.

USER

The XP-80's user memory contains 128 Patches that can be rewritten to create your own Patches.

PR-A–C (Presets A–C)

The XP-80 includes 384 preset Patches that are not user-rewritable. But you can call up preset Patch settings into the temporary area, modify them, and then store them in User memory.

GM (General MIDI)

GM Patches are for instruments compatible with the GM System. The aim of this system is to standardize MIDI specifications among different equipment makers or models. The XP-80 contains 128 GM Patches that are not user-rewritable. But you can call up GM Patch settings into the temporary area, modify them, and then store them in User memory.

XP-A–D (Wave Expansion Boards installed in EXP-A–D Slots)

The Patches included in optional Wave Expansion Boards are not user-rewritable. But you can call up those Patch settings into the temporary area, modify them, and then store them in User memory.

- * A Patch XP-A–D cannot be accessed if the Wave Expansion Board it belongs to has not been installed.

<Procedure>

- 1 Press [PATCH] to call up the Play display (PATCH).

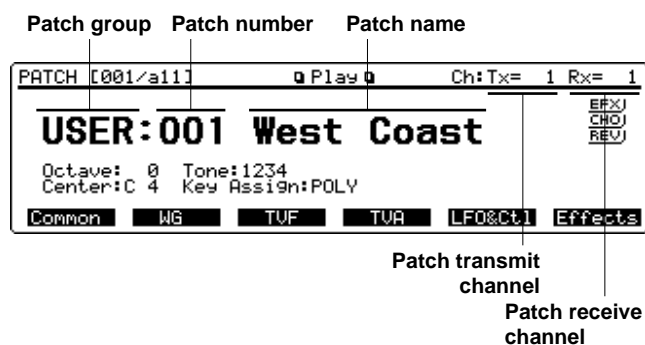

- 2 Turn the VALUE dial or press [INC]/[DEC] to select a Patch.

Selecting a Patch with Bank/Number method

You can select a Patch by combining BANK [1]–[8] and NUMBER [1]–[8] buttons in the center of the front panel. This selection style is called the 'Bank/Number method.'

When selecting a Patch on the XP-80 using the Bank/Number method, the bank/number corresponding to each Patch number is shown at the upper left of the display.

Patch number Bank/Number



Patch number: 001 002 003 ... 064 065 066 067

Bank/number: a11 a12 a13 ... a88 b11 b12 b13 ... b88

With the Bank/Number method, 64 Patches in bank 1/number 1 through bank 8/number 8 make up a single subgroup. Subgroups (a/b/c/d) can be changed in units of 64 Patches.

- * Subgroup c or d can be chosen only when selecting a Patch from a Wave Expansion Board.

<Procedure>

- 1 Press [PATCH] to call up the Play display (PATCH).
 - 2 Turn the VALUE dial, or press [INC]/[DEC] or numeric keys to select a Patch group.
 - 3 Press [a/b/c/d] to select a subgroup. Subgroups a and b will be toggled each time the button is pressed.
- * When selecting a Patch from a Wave Expansion Board, pressing this button will cycle through subgroups a, b, c, and d.
- 4 Press BANK [1]–[8] to select a bank.
 - 5 Press NUMBER [1]–[8] to select a number.

Selecting a Patch using numeric keys

You can use numeric keys to directly select a desired Patch.

<Procedure>

- 1 Press [PATCH] to call up the Play display (PATCH).
- 2 Hold down [SHIFT] and press numeric keys [0]–[8] to select a Patch group.

Patch group	Numeric key
USER	[SHIFT] + [0]
PR-A	[SHIFT] + [1]
PR-B	[SHIFT] + [2]
PR-C	[SHIFT] + [3]
GM	[SHIFT] + [4]
XP-A	[SHIFT] + [5]
XP-B	[SHIFT] + [6]
XP-C	[SHIFT] + [7]
XP-D	[SHIFT] + [8]

- ③ Use numeric keys to input a Patch number (001–128).
The Patch number and Patch name are boxed, meaning the entry has not yet been finalized.
- ④ Press [ENTER] to finalize the entry.

<Express Patch select (Digit Hold)>

With the Digit Hold function turned on, the 100's position and 10's position will be fixed when the numeric keys are used to select a Patch. This means that the numeric keys will only change the 1's position, and you won't have to press [ENTER] for each selection. The same applies to selecting Performances and Rhythm Sets.

<Procedure>

- ① Hold down [SHIFT] and press [ENTER] to turn on Digit Hold.

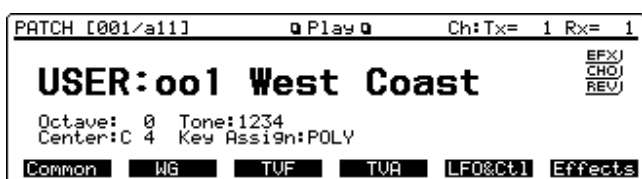

The numbers in the 100's position and 10's position will be displayed in a smaller size to indicate Digit Hold is on.

- ② When you enter a numeric key number, the 1's position will change immediately without having to press [ENTER].
- ③ To turn off Digit Hold, hold down [SHIFT] and press [ENTER] once again.

Displaying a Patch list

You can view a Patch list when selecting a Patch. Ten Patches are displayed at once for each Patch group, allowing your desired Patch to be quickly accessed. This Patch list is called the 'Sound List window.'

<Procedure>

- ① Make sure that the Play display (PATCH) is showing.
- ② Press [SOUND LIST] to display the Sound List window. The cursor is on the currently selected Patch. (Bank Select MSB=, LSB=) at the bottom line indicates the Bank Select (MSB and LSB) of the current Patch.



- ③ When changing Patches in units of 10, press either [F5] (-10) or [F6] (+10).
Patch groups can also be changed by pressing [F2] (-Group) or [F3] (+Group).
- ④ When selecting a Patch, turn the VALUE dial, or press [INC]/[DEC] or cursor buttons to move the cursor to the desired Patch.
- ⑤ Press [EXIT] to close the Sound List window.

Making a Patch sound thick or thin (turning a Tone on/off)

Since a Patch is a combination of up to four Tones, you can switch unwanted (Tones out of the four) off and get just the sound of a specific Tone.

- * Use the Tone Switch parameter (PATCH/WG/Wave Param) to set each Tone on/off. This setting can be stored as a part of Patch data. So if you want just one or two Tones to sound in a Patch, turn the others off and store that setting on a Patch. This cuts nonessential use of the XP-80's simultaneous voices.

<Procedure>

- ① Make sure that the Play display (PATCH) is showing.
- ② Press any button from [F1] (Common)–[F6] (Effect).
- ③ Use TONE SWITCH [1]–[4] (BANK [1]–[4]) to turn Tones on (indicator lights) or off (indicator off).

TONE SWITCH buttons switch Tones 1, 2, 3, and 4 on/off in sequence going from left to right.

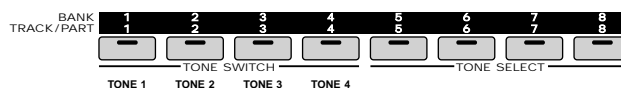

- ④ Press [EXIT] to return to the Play display (PATCH) and start playing the Patch.

"Tone:" at the display bottom center shows the numbers of Tones which are turned on. The Tones turned off are indicated with "-."

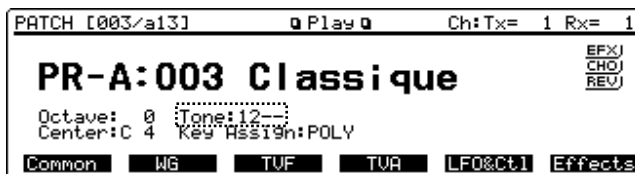

Playing single notes (Solo)

Normally, the XP-80 allows you to play chords. Pressing [SOLO] allows performance using single notes. This function is effective when performing a solo using single-note Patches like sax and flute.

- * The Solo function on/off setting can be stored as a part of each Patch setting using the Key Assign parameter (PATCH/Common/Common Control).

<Procedure>

- 1 Make sure that the Play display (PATCH) is showing.
- 2 Press [SOLO] so its indicator lights.

Now you can play a solo.

- * This setting is also shown for “Key Assign” at the bottom center of the display.

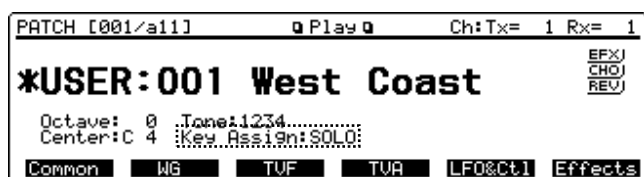

- 3 Play the XP-80 keyboard.
- * If you press [SOLO] when Single Performance is selected, the Solo function can be switched on or off for the current Part. When Layer Performance is selected, the Solo function can be switched on or off for the Parts with the Local Switch parameter (PERFORM/MIDI/Part MIDI) set ON. If a Rhythm Set is selected, [SOLO] cannot be turned on.

Creating smooth pitch changes (Portamento)

Portamento ensures a smooth pitch changeover from one note to the next note played. When [SOLO] is on (indicator lights), you can simulate techniques like violin glissandos.

- * The Portamento function on/off setting can be stored as a part of each Patch setting using the Switch parameter (PATCH/Common/Common Control).

<Procedure>

- 1 Make sure that the Play (PATCH) display is showing.
- 2 Press [PORTAMENTO]. Its indicator lights.

You're ready to play portamento.

- 3 To adjust portamento, Press [F1] (Common), then [F2] (Control) to call up the Common Control display (PATCH/Common).

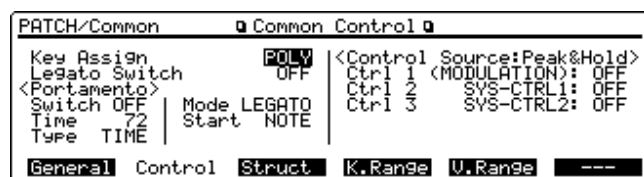

- 4 Move the cursor over to Time, Type, Mode or Start parameter.

See p.47 for each parameter's functions.

- 5 Turn the VALUE dial or press [INC]/[DEC] to get the value you want.
 - 6 Press [EXIT] to return to the Play display (PATCH) and play.
- * If you press [PORTAMENTO] when Single Performance is selected, the Portamento function can be switched on or off for the current Part. When Layer Performance is selected, the Portamento function can be switched on or off for the Parts with the Local Switch parameter (PERFORM/MIDI/Part MIDI) set ON. If a Rhythm Set is selected, [PORTAMENTO] cannot be turned on.

Quick sound character changes (Sound Palette)

With the four sliders in the Sound Palette section, you can create sound variations or volume changes in real time.

- * Sound variations or volume changes made with the Sound Palette affect only the performance. They have no effect on current Patch settings. Change the Patch and these Sound Palette settings will be lost.
- * The sound character and volume changes created using the Sound Palette will also be transmitted to the XP-80's sequencer and external MIDI devices.

Changing sound characters

<Procedure>

- 1 Make sure that the Play display (PATCH) is showing.
- 2 Press [FILTER/ENV] and its indicator lights.
- 3 Move the sliders while you play to vary the sound.

To modify the brightness, move the CUTOFF slider.

To change resonance, move the RESO. slider.

To change attack time, move the ATTACK slider.

To change decay time, move the DECAY slider.

Changing the volume of each Tone

<Procedure>

- 1 Make sure that the Play display (PATCH) is showing.
- 2 Press [LEVEL] and its indicator lights.
- 3 Move the LEVEL slider as you play the keyboard to adjust volume as desired.

Sliders 1, 2, 3, and 4 are used to change the volume of Tones 1, 2, 3, and 4, respectively.

Playing in Performance mode

There are Single and Layer Performances. The “Key Mode:LAYER” indication under the Performance name represents Layer Performance, while the “Key Mode:SINGLE” indication represents Single Performance.

Layer Performance allows playing two or more Parts simultaneously on the keyboard. Select Layer Performance if you want fat, rich sounds of two or more Patches, or play different Patches in a split keyboard’s different sections.

Single Performance plays only the Part shown in the display (current Part). Select Single Performance for playing a song using two or more instruments.

- * Make your Performance type selection with the Key Mode parameter (PERFORM/Common/Common) . The Key Mode parameter determines how the XP-80 keyboard will play the internal sound source. It has no effect on how the XP-80 sound source is played from the built-in sequencer or an external MIDI device.

Selecting a Performance

The XP-80 offers three groups of Performances (User, Presets A and B) with each group having 32 Performances. A total of 96 Performances is available.

USER

The XP-80 user memory includes 32 Performances that can be rewritten to produce your own Performances.

PR-A–B (Preset A–B)

The XP-80 contains 64 preset Performances that cannot be rewritten. But you can call up preset Performance settings into the temporary area, modify them, and then store them in user memory.

<Procedure>

- 1 Press [PERFORM] to call up the Play display (PERFORM).

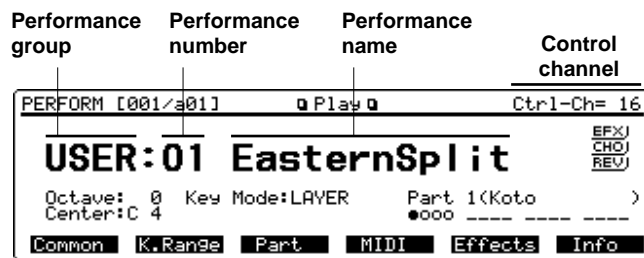

- 2 Turn the VALUE dial or press [INC]/[DEC] to select a Performance.

Selecting a Performance with Subgroup/Number method

You can select a Performance using TRACK/PART [1]–[16] at front panel center. Each Performance group contains 32 Performances, so you can choose a Performance using 16 buttons in subgroups a and b.

If you use this method to select a Performance, you’ll see the subgroup and number corresponding to each Performance number at the upper left of the display.

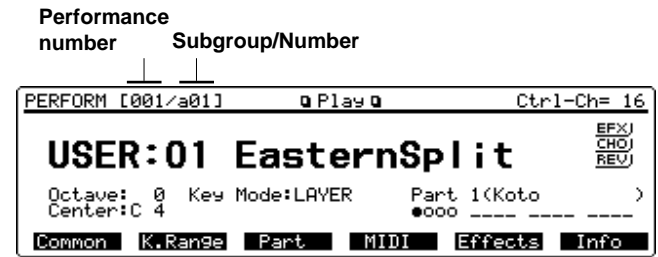

Performance number: 01 02 03 ... 16 17 18 19 ... 32

Subgroup/number: a01 a02 a03 ... a16 b01 b02 b03 ... b16

<Procedure>

- 1 Press [PERFORM] to call up the Play display (PERFORM).
- 2 Turn the VALUE dial, or press [INC]/[DEC] or numeric keys to select a Performance group.
- 3 Press [a/b/c/d] to select a subgroup. Subgroups a and b will toggle with each button press.
- 4 Press a button from TRACK/PART [1]–[16] to select a number.

Selecting a Performance using numeric keys

You can choose a Performance with direct numeric key input.

<Procedure>

- 1 Press [PERFORM] to call up the Play display (PERFORM).
- 2 Hold down [SHIFT] and press numeric keys [0]–[2] corresponding to your desired Performance group.

Performance group Numeric key

USER [SHIFT] + [0]

PR-A [SHIFT] + [1]

PR-B [SHIFT] + [2]

- 3 Use numeric keys to input the Performance number (001–032).

The Performance number and Performance name are boxed, indicating that the Performance has not yet been finalized.

- 4 Press [ENTER] to finalize the entry.

- * Using Digit Hold, a Performance can be selected simply by specifying the 1’s place number (p.27).

Displaying a Performance’s Sound List window

A Performance Sound List window can be viewed. Ten Performances are displayed in sequential order at one time for each Performance group so you can quickly select the desired Performance.

<Procedure>

- 1 Make sure that the Play display (PERFORM) is showing.
- 2 Press [SOUND LIST] to display the Sound List window.

The cursor is at the current Performance. (Bank Select MSB=, LSB=) at the bottom line indicates the Bank Select (MSB and LSB) of the current Patch.

- ③ When changing Performances in units of 10, press either [F5] (-10) or [F6] (+10).

Holding down either button will change Performance groups as well. Performance groups can also be changed by pressing [F2] (-Group) or [F3] (+Group).

- ④ When selecting a Performance, turn the VALUE dial, or press [INC]/[DEC] or cursor buttons to move the cursor to the desired Performance.
- ⑤ Press [EXIT] to close the Sound List window.

Playing fatter and richer sounds by combining Patches (Layer)

If a Layer Performance is selected, you can play all Parts with the Local Sw parameter (PERFORM/MIDI/Part MIDI) ON. Combining the Parts will produce, thicker, fatter sounds.

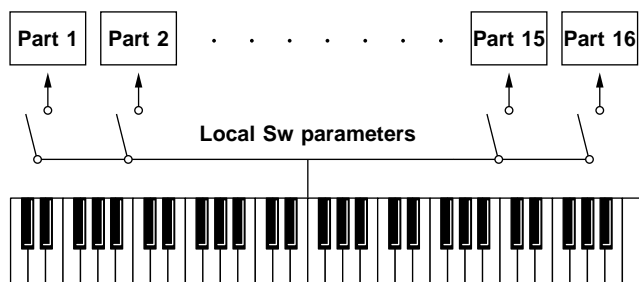

<Procedure>

- ① Make sure that Play display (PERFORM) is showing.
- ② Note “Key Mode:LAYER” is below the Performance name.

If “Key Mode:SINGLE” is displayed, it means that a Single Performance is selected. Change it to Layer Performance.

- ③ Press [LOCAL/TX/RX] to open the LOCAL/TX/RX window.



- ④ Press [F5] (K.Mode) to select LAYER. Pressing this button again re-selects SINGLE.

* If you set the Key Mode parameter in the LOCAL/TX/RX window, the Key Mode parameter (PERFORM/Common/Common) value will also change.

- ⑤ Making sure that the cursor is positioned at the Local Sw parameter, press TRACK/PART [1]–[16] to turn on the Part you want to hear (indicator lit).

The display will indicate “o” for the Parts with Local Sw parameter ON and “-” for the Parts with Local Sw parameter OFF.

* The setting you make in the LOCAL/TX/RX window will also affect the Local Sw parameter value (PERFORM/MIDI/Part MIDI).

- ⑥ After you complete your settings, press [LOCAL/TX/RX] or [EXIT] to close the LOCAL/TX/RX window and return to the Play display (PERFORM). Now start playing.

The lower right of the display will indicate “o” for the Parts with Local Sw parameter ON and “-” for the Parts with Local Sw parameter OFF. The cursor is located on the current Part selected.

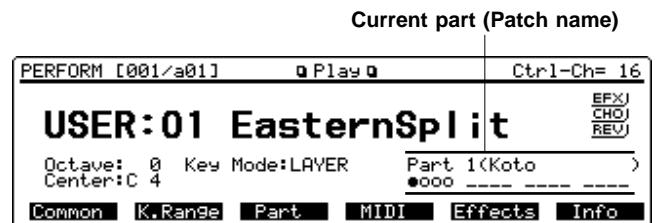

Splitting the keyboard to play separate Patches in different sections (Split)

If you’ve selected a Layer Performance, you can split the keyboard to play separate Patches with different sections of the keyboard. As the note range that plays each Part can be specified individually, you can split the keyboard into a maximum of 16 sections.

For instance, you can play strings in the lower note section, piano in the higher note section and both sounds in the middle note section.

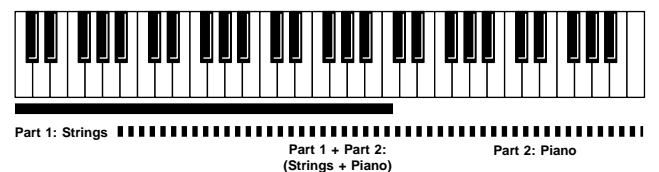

* If a K.Range Lower:Upper display(PATCH/Common) has been set, sounds are produced in the overlapping sections between the key ranges specified for the Patch and Performance.

<Procedure>

- ① Make sure that the Play display (PERFORM) is showing.
- ② Press [LOCAL/TX/RX] to open the LOCAL/TX/RX window.
- ③ If you have selected a Single Performance, Press [F5] (K.Mode) to select LAYER.

Pressing this button again re-selects SINGLE.

* If you set the Key Mode parameter in the LOCAL/TX/RX window, the Key Mode parameter (PERFORM/Common/Common) value will also change.

- ④ Making sure that the cursor is positioned at the Local Sw parameter and press a button from TRACK/PART [1]–[16] so the button indicator of the Part you wish to play lights.

On the display, Parts with Local Sw parameter ON are shown with “o,” and those with Local Sw parameter OFF with “-.”

- * The setting you make in the LOCAL/TX/RX window will also affect the Local Sw parameter value (PERFORM/MIDI/Part MIDI).
- ⑤ Make sure that the Key Range parameter is set ON. If OFF, press [F6] (K.Range) to set it ON.
- * If the Key Range parameter is OFF, the keyboard cannot be split even when you set the key range.
- * If you set the Key Range parameter in the LOCAL/TX/RX window, the switch parameter (PERFORM/K.Range/Part Key Range Lower:Upper) value will also change.
- ⑥ After completing your settings, press [LOCAL/TX/RX] or [EXIT] to close the LOCAL/TX/RX window.
- ⑦ Press [F2] (K.Range) to call up the Part Key Range Lower:Upper display (PERFORM/Common).

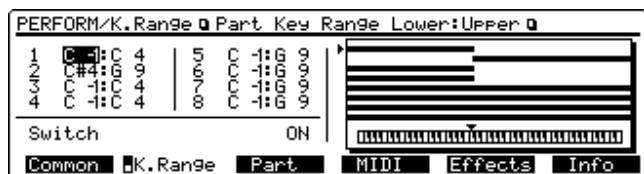

- * Part Key Range Lower:Upper display (PERFORM/Common) is available in two pages: one for displaying Parts 1 through 8 and the other for displaying Parts 9 through 16. To flip between these two pages, press [F2] (K.Range).
- ⑧ Move the cursor to a Part with Local Sw parameter ON and specify the note range while confirming this operation on the display.

The value at left of each Part indicates the lowest note (lower) and the value at right indicates the highest note (upper).

- * By specifying sections for different Parts so that they overlap each other, you can combine two or more Patches only in a specific section.
- ⑨ After completing your settings, press [EXIT] to return to the Play display (PERFORM) and start playing.

Playing along with a song playback (XP-80 used as a multitimbral sound source)

When a Single Performance is selected, the XP-80's keyboard will play only the Part you selected from the keyboard, convenient when you play the keyboard along with a song playback.

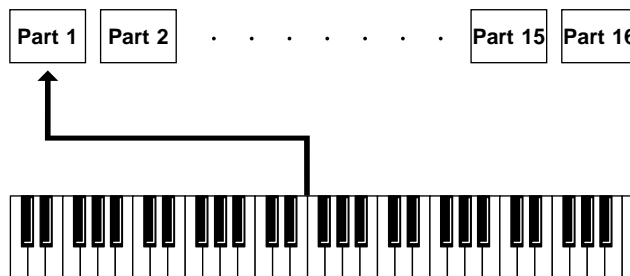

Selecting a Part you want to play on the keyboard

If a Single Performance is selected, press [◀] or [▶] to select the Part you want to play. The selected Part is called the 'current Part.'

<Procedure>

- ① Make sure that the Play display (PERFORM) is showing.
- ② Press [◀] or [▶] to choose the Part to be played.

The current Part number will be seen at the lower right of the display with the Patch name indicated within parentheses (). The cursor (●) also moves to the current Part.

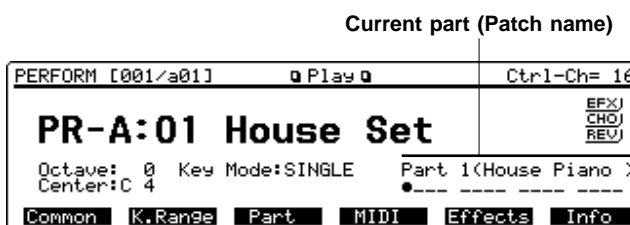

Muting a specific Part (turning Receive channel on/off)

While you play along with the playback of a song, you can turn on/off any specific Part. This allows you to turn off the melody Part for karaoke applications or for practicing the muted Part.

<Procedure>

- ① Press [LOCAL/TX/RX] to open the LOCAL/TX/RX window.
- ② Move the cursor to the Rx Switch parameter and press a button from TRACK/PART [1]-[16] to mute the Part. The button indicator of the muted Part will go off.

On the display, Parts which are on are shown with “o,” and those off are shown with “-.”

- * The setting you make in the LOCAL/TX/RX window will also affect the Rx Switch parameter value (PERFORM/MIDI/Part MIDI).

Assigning a different Patch to a Part

- * The Patch assigned to each Part can be stored as a part of a Performance using Patch Group parameter and Patch Number parameter (PERFORM/Part/Part Param).

<Procedure>

- 1 Make sure that the Play display (PERFORM) is showing.
- 2 Press [◀] or [▶] to choose the Part to which you want to assign a different Patch.
- 3 While holding down [PERFORM], press [PATCH] or [▼] to call up the Play display of the Patch assigned to a specific Part.

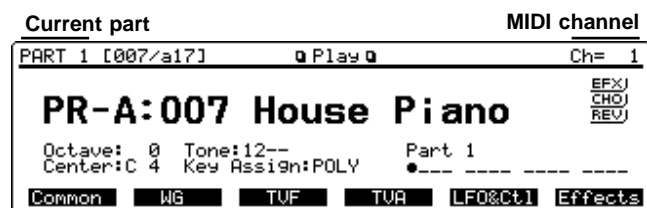

The current Part number is shown at the lower right of the display and the cursor moves to the Part.

- 4 Use the same procedure as in Patch mode to select a Patch.
- 5 Press [PERFORM] or [EXIT] or [▲] to return to the Play display (PERFORM).

Quick sound character changes (Sound Palette)

Using the Sound Palette function, you can modify sound characters of the Patch assigned to a Part or adjust the volume level of each Part.

- * Sound variations or volume changes made with the Sound Palette function affect only the performance. They have no effect on the currently selected Performance, so the Sound Palette settings cannot be saved. If you change the Performance, these settings will be lost.
- * The sound character and volume changes created using the Sound Palette will also be transmitted to the XP-80's sequencer and external MIDI devices.

Changing sound characters

- * If Single Performance is selected, the effect applies only to the current Part. With Layer Performance selected, this affects only the Parts with Local Switch parameter (PERFORM/MIDI/Part MIDI) set ON.

<Procedure>

- 1 Make sure that the Play display (PERFORM) is showing.
- 2 Press [FILTER/ENV] to light its indicator.
- 3 Move the sliders while you play the XP-80's keyboard to vary the sound.

To change brightness, move the CUTOFF slider.

To change resonance, move the RESO slider.

To change attack time, move the ATTACK slider.

To change decay time, move the DECAY slider.

Changing the level (volume) of each Part

<Procedure>

- 1 Make sure that the Play display (PERFORM) is showing.
- 2 Press [LEVEL] to light its indicator.
- 3 Press [◀] or [▶] to select the Part whose level (volume) you want to change.

If you've selected any of Parts 1-4, sliders 1, 2, 3, and 4 adjust Parts 1, 2, 3, and 4, respectively.

If you've selected any of Parts 5-8, sliders 1, 2, 3, and 4 adjust Parts 5, 6, 7, and 8, respectively.

If you've selected any of Parts 9-12, sliders 1, 2, 3, and 4 adjust Parts 9, 10, 11, and 12, respectively.

If you've selected any of Parts 13-16, sliders 1, 2, 3, and 4 adjust Parts 13, 14, 15, and 16, respectively.

- 4 Move the slider as you play to adjust the level (volume) of each Part as desired.

Playing in Rhythm Set mode

In Rhythm Set mode, you can play percussion instruments (Rhythm Tones) on the keyboard. As the Rhythm Tone assigned to each key varies by the Rhythm Set selected, you can play a wide range of percussion instruments.

Selecting a Rhythm Set

The XP-80 offers five groups of Rhythm Sets (User, Presets A-C and GM) with each group having two Rhythm Sets – a total of 10 Rhythm Sets. In addition, up to four optional Wave Expansion Boards can be installed for accessing even more percussion instruments.

USER

The XP-80's user memory contains two Rhythm Sets that can be rewritten to make up your own Rhythm Sets.

PR-A-C (Presets A-C)

The XP-80 includes six preset Rhythm Sets that are not user-rewritable. But you can call up preset Rhythm Set settings into the temporary area, modify them, and then store them in user memory.

GM (General MIDI)

GM Rhythm Sets are for instruments compatible with the General MIDI System intended to standardize MIDI specifications among different equipment makers or models. The XP-80 offers two GM Rhythm Sets that are not user-rewritable. But you can call up GM Rhythm Set settings into the temporary area, modify them, and then store them in user memory.

XP-A-D (Wave Expansion Boards installed in EXP-A-D Slots)

These Rhythm Sets are included in optional Wave Expansion Boards and are not user-rewritable. But you can call up Rhythm Set settings into the temporary area, modify them, and then store them in user memory.

* A Patch XP-A-D cannot be accessed if the Wave Expansion Board it belongs to has not been installed.

<Procedure>

- 1 Press [RHYTHM] to call up the Play display (RHYTHM).

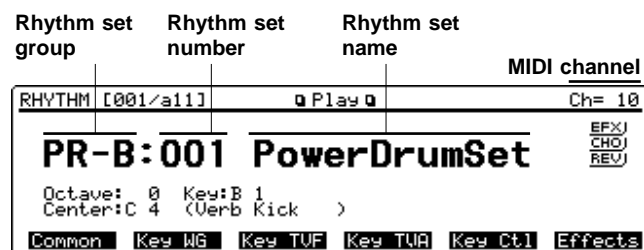

- 2 Turn the VALUE dial or press [INC]/[DEC] to select a Rhythm Set.

Selecting a Rhythm Set with Bank/Number method

You can select a Rhythm Set by combining BANK [1]-[8] and NUMBER [1]-[8] located at front panel center. This is called 'Bank/Number method.' However, when you select a Rhythm Set stored in the XP-80, Bank is fixed at 1. So specify the number by pressing NUMBER [1] or [2] only.

The bank/number corresponding to each Rhythm Set number is shown at the upper left of the display for your reference when selecting a Rhythm Set using the Bank/Number method.

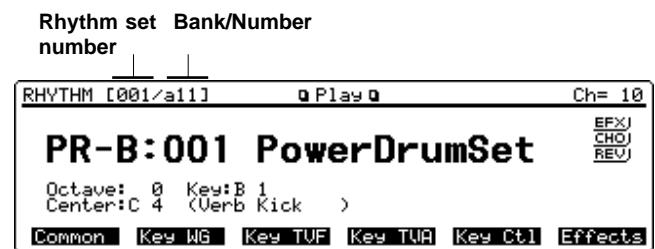

Rhythm Set number: 001 002 008

Bank/number: a11 a12 ... a18

<Procedure>

- 1 Press [RHYTHM] to call up the Play display (RHYTHM).
 - 2 Turn the VALUE dial, or press [INC]/[DEC] or numeric keys to select a Rhythm Set group.
 - 3 Press NUMBER [1]-[8] to select a number.
- * When selecting a Rhythm Set from a Wave Expansion Board, a bank and subgroup may have to be specified. For details, refer to the Owner's Manual for optional Wave Expansion Boards.

Selecting a Rhythm Set using numeric keys

Using numeric keys, you can direct input a desired Rhythm Set.

<Procedure>

- 1 Press [RHYTHM] to call up the Play display (RHYTHM).
- 2 Hold down [SHIFT] and press numeric keys [0]–[8] to select a Rhythm Set group.

Rhythm Set group Numeric key

USER	[SHIFT] + [0]
PR-A	[SHIFT] + [1]
PR-B	[SHIFT] + [2]
PR-C	[SHIFT] + [3]
GM	[SHIFT] + [4]
XP-A	[SHIFT] + [5]
XP-B	[SHIFT] + [6]
XP-C	[SHIFT] + [7]
XP-D	[SHIFT] + [8]

- 3 Use numeric keys to input a Rhythm Set number (001–002).

The Rhythm Set number and name are boxed, meaning the entry has not yet been finalized.

- 4 Press [ENTER] to finalize the entry.
- * Using Digit Hold, a Rhythm Set can be selected simply by specifying the 1's place number (p.27).

Displaying Sound List window of a Rhythm Set

The Sound List window for each Rhythm Set group is displayed so you can quickly choose a Rhythm Set.

<Procedure>

- 1 Make sure that the Play display (RHYTHM) is showing.
- 2 Press [SOUND LIST] to display the Sound List window.

The cursor is on the currently selected Rhythm Set. (Bank Select MSB=, LSB=) at the bottom line indicates the Bank Select (MSB and LSB) of the current Patch.

- 3 To call up another Rhythm Set group, press [F2] (-Group) or [F3] (+Group).
- * You can also change Rhythm Set groups by continuously pressing [F5] (-10) or [F6] (+10).
- 4 When selecting a Rhythm Set, turn the VALUE dial, or press [INC]/[DEC] or cursor buttons to move the cursor to the desired Rhythm Set.
 - 5 Press [EXIT] to close the Sound List window.

Playing percussion instruments

<Procedure>

- 1 Press [RHYTHM] to call up the Play display (RHYTHM).
- 2 Select a desired Rhythm Set.
- 3 Press a key on the keyboard to play a percussion instrument.

The key (Note name) you press and its percussion instrument name (Rhythm Tone name, the same as the Wave it uses) will be displayed below the Rhythm Set name.

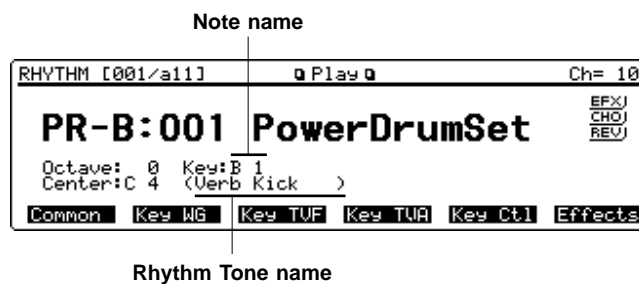

- * On the XP-60, when you want to play the percussive instrument sound assigned to the B1 key, first push [-OCT] once, then press the B2 key. Similarly, push [+OCT] once then press the C#6 or D6 key to play the percussive instrument sound assigned to the C#7 or D7 key. (On the XP-60, the leftmost white key is C2, and rightmost white key is C7.)

For details, refer to "Transposing the keyboard in octave units (Octave Shift)" (p. 37).

Playing an arpeggio

The XP-80's Arpeggiator lets you produce an arpeggio (broken chord) simply by playing a chord. In addition to normal arpeggios, you can also accurately simulate guitar cutting or strumming techniques depending on the Arpeggiator settings. The Arpeggiator can in fact be used as a handy automatic arranger.

By pressing [ARPEGGIO], the indicator lights and allows playing arpeggios from the XP-80 keyboard.

- * If you press [ARPEGGIO] to turn this function on when Single Performance is selected, the current Part will play arpeggios. When a Layer Performance is selected, an arpeggio will sound for the Part specified by the Part parameter (SYSTEM/Arpeg/Arpeggio).
- * The arpeggios played by the arpeggiator are also transmitted from the MIDI OUT connector to external MIDI devices.

(Basic Procedure)

- 1 Make sure that the Play display of a sound source mode (PERFORM, PATCH, RHYTHM or GM) is up.
- 2 Press [ARPEGGIO] to turn the Arpeggiator on.

The Arpeggio window for setting Arpeggiator parameters opens.



- * If the Play display of a sequencer mode (SEQ or CHAIN) is up, it is possible to turn the Arpeggiator on (the button indicator is lit) but the Arpeggio window will not open.
- * To change the sound while the Arpeggio window is open, use BANK [1]–[8], NUMBER [1]–[8] or [a/b/c/d].
- 3 If you wish to change the arpeggio style, move the cursor to "Arpeggio Style" and select the style you want.
- * The selection you make here will also affect the Style parameter (SYSTEM/Arpeg/Arpeggio) settings.

There are 33 arpeggio styles available. For selection, refer to the following guideline.

Playing an arpeggio according to the timing interval of a note

1/4–1/32

Playing a glissando

GLISSANDO

Playing a bass part

SYNTH BASS, SLAP BASS A, SLAP BASS B, WALK BASS

Playing a guitar

RHYTHM GTR A, RHYTHM GTR B, RHYTHM GTR C, RHYTHM GTR D, RHYTHM GTR E, 3FINGER GTR, STRUMMING GTR

Playing a keyboard instrument

KBD COMPING A, KBD COMPING B

Playing a waltz

KBD COMPING C, KBD COMPING D

Playing in reggae style

KBD COMPING E

Playing percussion instruments

PERCUSSION

- * There are also other styles besides the above, including those used for random play and for creating your own styles. For details regarding each style, refer to "Arpeggio display" (p.93).
- 4 When you wish to change the tempo of an arpeggio, move the cursor to "↓" and specify the value. If you want to play an arpeggio along with the song playback, set the tempo here.
- * This setting will also affect the Tempo parameter (SYSTEM/Arpeg/Arpeggio) settings.
- 5 To change the key range over which you want arpeggio to take place, move the cursor to "Oct" and specify the value.

If you want the arpeggio to sound using only the notes that you actually play, set this to 0. With a +1 setting, arpeggio will take place over a range up to 1 octave higher than the notes you play. A -1 setting will result in arpeggio occurring over the range down to 1 octave lower than the notes you play.

- * This setting will also affect the Octave Range parameter (SYSTEM/Arpeg/Arpeggio) settings.
- 6 To close the Arpeggio window, press [F6] (Close).

To reopen the Arpeggio window, press [F6] (Arpeg).

- * When the Arpeggio window is closed, [F6] will be assigned to re-open the Arpeggio window. If you wish to use the button's original function on each Play display, hold down [SHIFT] as you press [F6].
- * If you don't like opening the Arpeggio window each time [ARPEGGIO] is pressed, set the Arpeggio Window parameter (SYSTEM/Arpeg/Arpeggio) DISABLE.
- 7 Play a chord to produce an arpeggio.
- * If you play a chord while a song is playing back, an arpeggio will begin at the timing of the following eighth note.
- 8 To stop the arpeggio, press [ARPEGGIO] to turn off the indicator.

The Arpeggio window will also close.

Playing an arpeggio over a preset keyboard area

As soon as you press [ARPEGGIO] to turn the Arpeggiator on, the keyboard will be set to play arpeggios so conventional keyboard playing is no longer possible.

If you split the keyboard into two different areas, you can use one area for normal playing and the other for playing arpeggios. This setting, for instance, allows you to play arpeggios with the left hand and a melody with the right hand.

<Procedure>

- 1 Press [PERFORM] to call up the Play display (PERFORM).
 - 2 If you have selected a Single Performance, set the Key Mode parameter (PERFORM/Common/Common) to LAYER.
 - 3 Set the Part parameter (SYSTEM/Arpeg/Arpeggio) to the Part you want for playing arpeggio.
 - 4 Set the Local Switch parameter (PERFORM/MIDI/Part MIDI) ON for the Part you want to hear.
 - 5 Press [F2] (K.Range) to call up the Part Key Range Lower:Upper display (PERFORM/K.Range).
 - 6 Set the Switch parameter (PERFORM/K.Range) ON.
 - 7 Move the cursor to the Part you want playing arpeggio, and set the key range.
 - 8 Move the cursor to another Part (that doesn't need to play arpeggio), and set the key range so that it does not overlap with the key range for playing arpeggio.
 - 9 After you finish settings, call up the Play display (PERFORM) again and play a chord.
- * If you play an arpeggio using Layer Performance but without setting key range, the chords will sound for all Parts except for the specified Part.

Holding an arpeggio

If you play an arpeggio while pressing the hold pedal, the arpeggio will continue to be played even if you release the chord.

<Procedure>

- 1 Connect an optional pedal switch to the HOLD jack.
- 2 Play a chord while pressing the hold pedal.
- 3 To play another chord, release the pedal, press it again as you play the next chord.

Simulating a guitar cutting technique

You can simulate a guitar cutting technique by following the procedure below. By using the Sound Palette, it is also possible to apply a wah effect as you play.

<Procedure>

- 1 Select a guitar Patch.
- 2 Set the Style parameter (SYSTEM/Arpeg/Arpeggio) to RHYTHM GTR B, RHYTHM GTR C, RHYTHM GTR D or RHYTHM GTR E.
- 3 Press [FILTER/ENV] so the indicator lights.
- 4 Move the CUTOFF slider or RESO slider while you play a chord.

Playing an arpeggio from an external MIDI device

The XP-80 can also produce arpeggios with incoming Note messages from an external MIDI device.

<Procedure>

- 1 Connect the XP-80's MIDI IN connector and the MIDI OUT connector of an external MIDI device with a MIDI cable.
- 2 Press [SYSTEM], then hold down MIDI [F3] until the MIDI Param 1 will appear.
- 3 Set the Remote Keyboard Sw parameter (SYSTEM/MIDI/MIDI Param 1) ON.
- 4 Play the external MIDI device.

Creating an arpeggio pattern

There are a total of 10 parameters that can be set for the Arpeggiator, but the most important is the Style parameter setting. The arpeggio pattern is largely determined by this setting.

When you set the Style parameter, the Motif, Beat Pattern, Accent Rate and Shuffle Rate parameters will automatically be set to optimum settings. This allows you to call up the most appropriate pattern simply by selecting the arpeggio style. After selecting the style, you can also set Octave Range and Key Velocity parameters, etc. In most cases, you'll specify the pattern in this way.

If this selection does not provide the pattern you want, modify the settings of the Motif, Beat Pattern, Accent Rate and Shuffle Rate parameters to add variations to the style as desired.

- * Motif, Beat Pattern, Accent Rate and Shuffle Rate settings will be lost if you select another style or turn the power off. These settings cannot be saved. Settings of other parameters (except the Tempo parameter) can be stored into system memory.
- * It is possible to store just one style into the system memory. Set the Style parameter to LIMITLESS then specify the Motif, Beat Pattern, Accent Rate and Shuffle Rate parameters as you like.

<Procedure>

- 1 Make sure that the Arpeggio window is open.
- 2 Press [F5] (Detail) to call up the Arpeggio display.

You can also call up this display by pressing [SYSTEM] then [F5] (Arpeg).

SYSTEM		Arpeggio	
Style	1/6	Octave Range	0
Motif	SINGLE UP&DOWN	Key Velocity	REAL
Beat Pattern	1/6	Part	1
Accent Rate	20%	Tempo(= SEQ)	120
Shuffle Rate	50%	Arpeggio Window	ENABLE
[Setup] [Tune] [MIDI] [Control] [Arpeg] [Info]			

- * For details regarding each parameter, refer to "Arpeggio display" (p.93)
- 3 Move the cursor to "Style" and specify the style you want.
- 4 Move the cursor to "Motif" and specify the order in which the notes of the chord will be played.

- * The available choices depend on the Style parameter setting. For details, refer to “Arpeggio Style list” (p.213).
- ⑤ Move the cursor to “Beat Pattern” to change the beat (rhythm).
- * The available settings will depend on the Style parameter setting. For details, refer to “Arpeggio Style list” (p.213).
- ⑥ Move the cursor to “Accent Rate” and specify the groove rate.

A 100% setting will result in the most pronounced ‘groove’ feel.

- ⑦ Move the cursor to “Shuffle Rate” and specify the swing rate.

With a setting of 50%, the notes will be spaced evenly. As the value increases, the note timing will have more of a ‘swing’ feel.

- ⑧ Move the cursor to “Octave Range” and specify the key range over which you want arpeggio.
- ⑨ Move the cursor to “Key Velocity” and specify the force of the chord.

When REAL is selected, the velocity at which the notes are actually played will be used. With a setting of 1–127, the specified velocity value will be used regardless of the force with which you play the chord.

- ⑩ If you want to play an arpeggio using Layer Performance, move the cursor to “Part” and specify the Part for which you want arpeggio.
- * Parts other than that specified here will not sound as arpeggios, and the notes of the chord will sound as you play.
- ⑪ Move the cursor to “Tempo” and specify the speed of an arpeggio.
- * The Tempo parameter works the same way as the sequencer tempo. Changing the Tempo parameter setting will also vary the song playback tempo.
- ⑫ After you finish settings, press [EXIT].

Recording an arpeggio

You can realtime record arpeggios just like with conventional playing.

<Procedure>

- ① Press [ARPEGGIO] to play an arpeggio.
- ② Make sure that Arpeggiator parameters have been set correctly.
- ③ Press [REC] to get ready for realtime recording.
- * To prepare for realtime recording, refer to “Recording as you play” (p.106).
- ④ Begin recording.

When you play a chord, an arpeggio will start at the timing of the next eighth note.

- ⑤ To stop recording, press [STOP/PLAY].

Convenient functions for performance

Transposing the keyboard in octave units (Octave Shift)

The Octave Shift function transposes the pitch of the keyboard in 1 octave units (-3- +3 octaves).

For playing a bass part more easily using your right hand, transpose the keyboard down by 1 or 2 octaves.

<Procedure>

- ① Press [+OCT] or [-OCT] and its indicator will light. Pressing [+OCT] once will raise the keyboard 1 octave and pressing [-OCT] once will lower it 1 octave.

The specified Octave Shift setting will be shown in the “Octave” and “Center” indication at the lower left of each Play display of the sound source. For instance, if you press [+OCT] once to raise the keyboard 1 octave, “Octave: +1, Center:C5” will be indicated. This means that when you press the C4 key, the C5 note will sound.



- * There is only one Octave Shift setting in the XP-80 so it remain valid even if you select a different Patch, Performance or Rhythm Set or turn power off.
- ② To turn off the Octave Shift function, press the other button [+OCT] or [-OCT] of that pressed in step 1 the same number of times. The indicator will go off.

Transposing the keyboard in semitone steps (Transpose)

Transpose changes keyboard pitch in units of semitones (-5-+6 semitones).

This function is useful when you play transposed instruments such as trumpet or clarinet following a printed score.

<Procedure>

- 1 Press [TRANSCOPE] to light indicator.

This turns Transpose on.

- 2 While holding down [TRANSCOPE], press [+OCT] or [-OCT] to transpose the keyboard.

Pressing [+OCT] once while holding down [TRANSCOPE] will raise the keyboard one semitone. Pressing [-OCT] once while holding down [TRANSCOPE] will lower the keyboard one semitone.

The specified Transpose setting will be added to the Octave Shift value. For example, if you hold down [TRANSCOPE] and press [+OCT] once to raise the keyboard a semitone, the display will indicate "CENTER:C#4." So when C4 is pressed, the C#4 note will sound.

- 3 To turn off Transpose, press [TRANSCOPE] once again so that its indicator goes off.

The Transpose setting you make will be maintained.

- * The Transpose setting you make here will also change the Transpose Value parameter (SYSTEM/Setup/Setup).
- * The setting you make will be maintained even if you select a different Patch, Performance or Rhythm Set, or turn the power off.

If 'stuck' notes occur or a note does not sound (Panic)

If a note played on the XP-80 or from an external device "locks" or keeps sounding and you can't shut it off, hit the Panic button. Do the same if a note does not sound.

When 'stuck' notes occur

<Procedure>

- 1 Press [SHIFT] and [EXIT] at the same time.

MIDI messages for Note Off and Hold Off will be transmitted to the Parts (MIDI channels) receiving Note On/Hold On messages.

- 2 The display will indicate "Muting..." while the Panic function is being executed. When this message goes off, you can start playing.

When a note does not sound

- 1 Press [SHIFT] and [EXIT] at the same time for more than a second.

MIDI messages for Volume (127), All Note Off, Pitch Bend (center), Channel Aftertouch (0), Modulation (0), and Hold 1 (0) will be transmitted to all Parts (MIDI channels).

- 2 The display will indicate "Transmitting..." while the Panic function is being executed. When this message goes off, you can start playing.

Chapter 3. Creating your own sounds

Regarding effects

The XP-80 contains three independent effects units.

EFX (multiple effects)

The EFX offers 40 different effects ranging from single effects such as distortion and delay to powerful combination effects. The EFX also includes chorus and reverb effects which are independent of the Chorus and Reverb outlined below.

Chorus

Chorus adds depth and spaciousness to the sound.

Reverb

Reverb adds reverberation characteristics of hall or auditorium ambiances.

Connection of the three effects units depend on the mode you've selected.

How effects units work in different modes

In Patch mode

The EFX, Chorus and Reverb effects can be set individually for each Patch. Adjusting the signal level to be sent to each effects unit (Send Level) provides control over the effect intensity that's applied to each Tone.

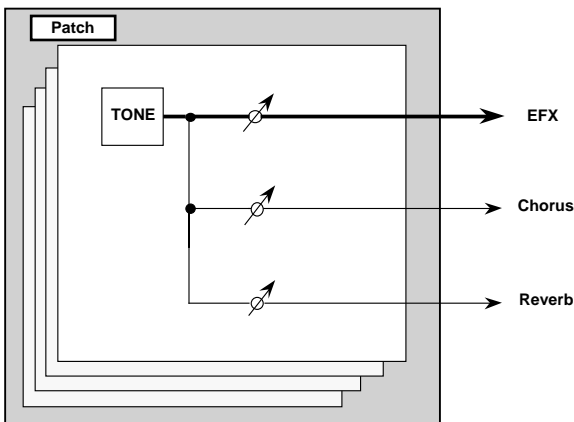

In Performance mode/GM mode

The EFX, Chorus and Reverb effects can be set individually for each Performance and GM mode. The intensity of each effect will be set for each Part (Fig. 1), but the Send Level setting for each Tone can also influence effect intensity (Fig. 2). Effects settings of the Patch assigned to each Part will be ignored, but EFX applied to a Patch assigned to a given Part can also be applied to the entire Performance.

Fig.1 – When Output Assign is set to "EFX" in the Performance mode (the output settings for Tone are ignored)

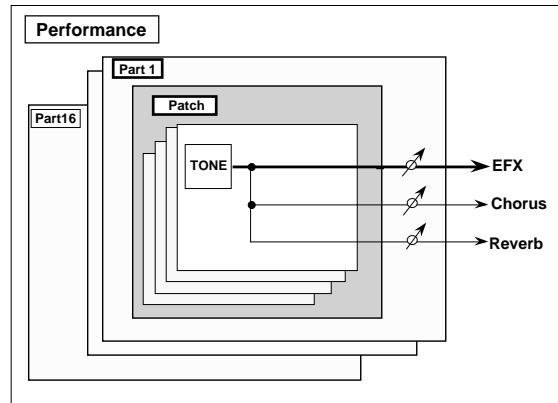
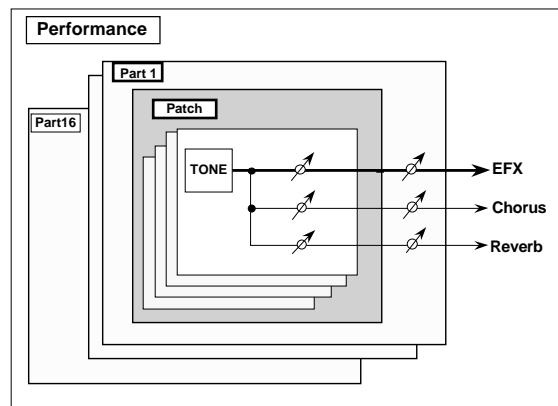

Fig.2 – When Output Assign is set to "Patch" in the Performance mode (the output settings for Tone are valid)



In Rhythm Set mode

Because in Rhythm Set mode, only Part 10 of a Performance is called up, the effects settings of a Performance in the temporary area will be used.

Turning effects on/off

Built-in effects units (EFX, Chorus and Reverb) can be turned on/off for the XP-80 as a whole. Turn them off if you want to edit sound while listening to the original sound or if you want to use external effects units.

<Procedure>

- Press [EFX], [CHORUS] and [REVERB] to switch each on (indicator lights) or off (indicator off).

On the Play display of each sound source, EFX, CHO, and REV are respectively indicated at right when switched on.



- * If [EFX], [CHORUS] and/or [REVERB] are OFF, parameter settings will have no effect. On the General display (PATCH/Effects), (PERFORM/Effects) or (RHYTHM/Effects), effects which are turned off will be indicated with a gray box.

Sound editing procedures

With the XP-80, you have total control over various settings. Each item to be set is a parameter. Editing refers to modifying any parameter value. This section goes over editing procedures for Patches, Performances and Rhythm Sets.

Editing a Patch

Start by editing a preexisting Patch to create a new one. Since a Patch is a combination of up to any four Tones, you should listen to how the individual Tones sound before you edit.

<Four tips for editing Patches>

Start with a Patch that's somewhat familiar sounding

It's hard to create a new sound that's exactly what you want if you just select a Patch and modify its parameters at random. It makes sense to start with a Patch whose sound is related to what you have in mind.

Deciding on the Tone to use

When creating a Patch, deciding on the Tones you'll use is crucial. For each Tone, use the TONE SWITCH [1]–[4] (BANK [1]–[4]) to decide whether to turn it on (have it sound) or off. Turn off Tones you don't need to avoid using more voices than required. A Tone switches on/off each time its respective button is pressed. When a Tone's indicator lights, it'll sound.

Check the Structure setting

The important Structure Type parameter (PATCH/Common/Structure) determines how the four Tones combine. Before editing Tones, make sure you really understand how they work together.

Turn off effects

Since XP-80 effects really influence the sound, turn them off to listen to the sound itself so you can better evaluate the changes you're making. Sometimes just changing effects settings can give you the sound you want.

<Procedure>

- In the Play display (PATCH), press a button from [F1] (Common)–[F6] (Effects) to choose the display group you want.
- Press a button from [F1]–[F6] to call up the desired display page.
- If you have selected any of [F2] (WG)–[F6] (Effects) in step 1, press TONE SELECT [1]–[4] (BANK [5]–[8]) to choose the Tone you wish to modify. The button indicator of the selected Tone will light and the Tone number will appear at the display upper right.

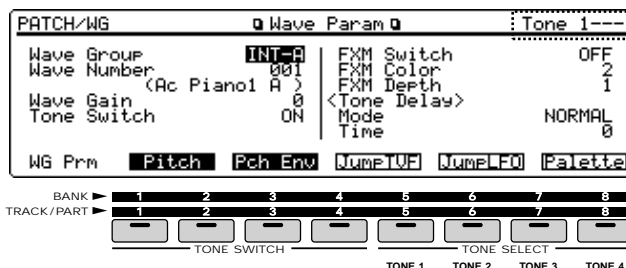

For simultaneously modifying the same parameter for two or more Tones, hold down one of TONE SELECT [1]-[4] buttons and press another TONE SELECT [1]-[4] button, then another if so desired. An asterisk (*) will be indicated for Tones other than the first-selected Tone.

If you decide not to edit a specific Tone, press TONE SELECT [1]-[4] corresponding to that Tone while holding down [SHIFT]. Pressing TONE SELECT [1]-[4] while holding down [SHIFT] again allows that Tone to be edited.

- * If you have selected [F1] (Common) in step 1, your editing will modify a parameter that's common to the entire Patch so you can't pick any specific Tone to modify.
- ④ Press the cursor buttons to move the cursor to the parameter you want to modify.
- ⑤ Use the VALUE dial, [INC]/[DEC] or numeric keys and modify the parameter value.

If you've selected two or more Tones, your editing will modify the parameter values for all selected Tones by the same amount.

- * If you've made a mistake in setting the parameter value or you don't like the changes, just press [UNDO/REDO] to restore the value to what it was.
- ⑥ Repeat steps 1-5 to complete a Patch.
- ⑦ When you finish making settings, press [EXIT] or [PATCH] to return to the Play display (PATCH).

An asterisk (*) will be displayed at the left of the Patch group. This shows patch settings have been modified.

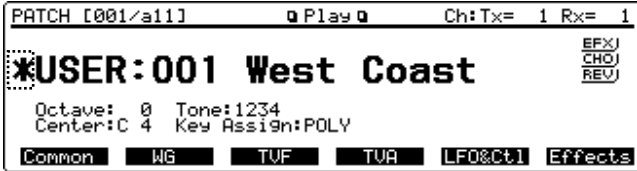

- * If you select another Patch in the group with an asterisk (*), the modified Patch settings will be lost. If you wish to keep these modified settings, you must write them into user memory (p.46).

<GoTo an another display group>

In each of the WG, TVF, TVA and LFO&Ctl display groups, the GoTo function is assigned to [F4] and [F5] buttons. [F4] cycles through WG, TVF and TVA in this order. For instance, using [F4] when you set each group's envelope speeds up the process.

[F5] switches between LFO&Ctl and WG, between LFO&Ctl and TVF, and between LFO&Ctl and TVA display groups. It's especially convenient when changing LFO depth or depth of Control 1&2.

Editing Patches using the Palette display

When editing a Tone in a Patch, the parameter values of the four Tones can be displayed together on a single display called the 'Palette display.' Use it when you want to modify parameter values as you compare the settings of the four Tones.

<Procedure>

- ① When modifying a Tone, press [F6] (Palette) to call up the Palette display.

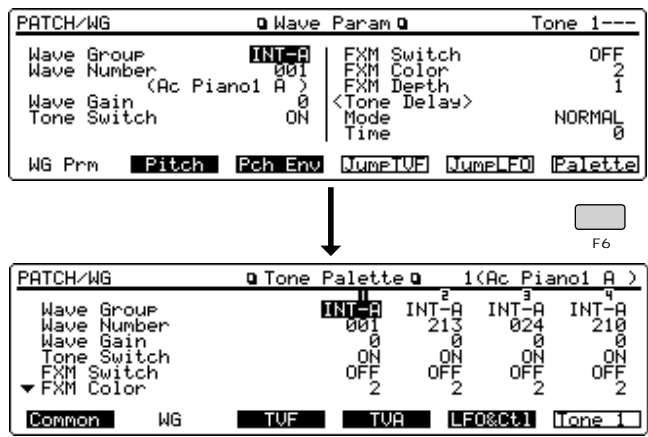

- * You can press [F6] (Palette) only when the Palette display can be active.
- ② Press a TONE SELECT [1]-[4] button, [◀] or [▶] to choose the Tone to modify.

The button indicator for the selected Tone will light and the Tone number and Wave name appear at the display upper right.

For modifying the same parameter of two or more Tones simultaneously, hold down one of TONE SELECT [1]-[4] buttons and press another. All selected Tones will be highlighted.

If you decide not to edit a specific Tone, press TONE SELECT [1]-[4] corresponding to that Tone while holding down [SHIFT]. Pressing TONE SELECT [1]-[4] while holding down [SHIFT] again allows that Tone to be edited.

- ③ Press [▲] or [▼] to move the cursor to the parameter you're going to modify.
- ④ Use the VALUE dial, [INC]/[DEC] or numeric keys to change the parameter value.

If you've selected two or more Tones, your editing will modify the parameter values for all selected Tones by the same amount.

If you want to set all selected Tones to the same value, select the Tone having that value by pressing [◀] or [▶] (the selected Tone number will be highlighted) and while holding down [SHIFT], press [ENTER].

- * If you've made a mistake in setting the parameter value or you don't like the changes, press [UNDO/REDO] to restore the value to what it was.
- ⑤ Repeat steps 1-4 to complete a Patch.
- ⑥ To exit the Palette display, press [F6].

The Tone number that the display will return to will be indicated for [F6].

Note on Tone editing

Because the XP-80 is designed to create wholly realistic sounds, editing necessarily affects the complex PCM waveforms sound are based on. So if you try to create a sound which is totally different from the original waveform, the results may not be what you want. XP-80 waveforms are divided into:

One-shot: These waveforms contain sounds that have short decays. A one-shot waveform records the initial rise and fall of the sound. Some of the XP-80's one-shot waveforms are sounds that are complete in themselves, such as percussive instrument sounds. The XP-80, however, contains many other one-shot waveforms that are only partial elements of sounds. These include attack components such as piano hammer sounds and guitar fret noises.

Looped: These waveforms contain sounds with long decays or sustained sounds. With looped waveforms, the latter part of the sound is generated repeatedly over a specified portion of the waveform for as long as the note is held (allowing wave memory to be used more efficiently). The XP-80's looped waveforms include such sound components as piano string vibrations and hollow sounds of brass instruments.

The following diagram shows an example of sound (electric organ) that combines one-shot and looped waveforms.

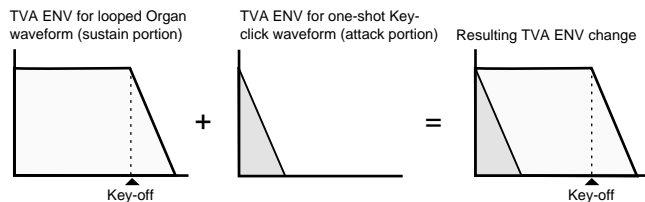

Notes for editing one-shot waveforms

An envelope cannot be used for giving a one-shot waveform a longer decay than the original waveform's, or make it a sustaining sound. Even if you were to make such envelope settings, you would simply be controlling a non-existent portion of the sound, so such settings would have no meaning.

Notes for editing looped waveforms

With many acoustic instruments like piano and sax, radical timbral changes occur during the first few moments of the note. This initial attack is what defines much of the instrument's character. The XP-80 provides a variety of waveforms containing realistic acoustic instrument attacks. To obtain the maximum realism when using these waveforms, it is best to leave the filter wide open during the attack. This way, all the complex timbral changes can be heard. For the decay portion of the sound, you can use the envelope to produce the desired changes. If you use the envelope to modify the attack portion as well, the natural attack contained in the waveform itself will not be heard to full advantage, and you may not achieve the result you want.

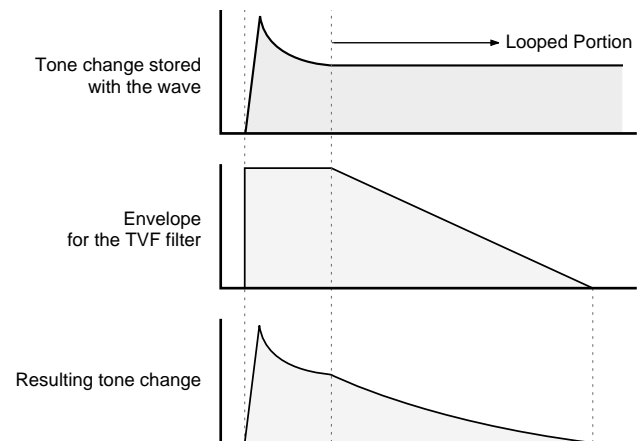

If you try to make just the attack brighter and subdue just the decay using the TVF filter, you need to keep in mind the timbral characters of the original waveform. And particularly if you're making a part of the sound brighter than the original waveform, you should first generate upper harmonics (not present in the original waveform) using FXM Color and FXM Depth parameters (PATCH/WG/Wave Param) before filtering. If you don't, the results will be disappointing. To make the entire sound brighter than the original waveform, try adjusting effects such as enhancer and equalizer before modifying the parameter values on the TVF Param (PATCH/TVF) display.

Editing a Performance

Start with an existing Performance and edit it to create a new Performance. But before you do, try to envision what the entire Performance will sound like and decide which Patch to assign to each of 16 Parts.

<Procedure>

- ❶ In the Play display (PERFORM), press a button from [F1] (Common)–[F6] (Info) to choose a display group.
- ❷ If you have selected Effects or Info group, press a button from [F1]–[F6] to call up the desired display page.
- * As the Common, K.Range, Part and MIDI display groups have only one display page, you can call up the desired display page simply by selecting any of these groups.
- ❸ If you have pressed any of [F2] (K.Range)–[F5] (Effects) in step 1, press TRACK/PART [1]–[16] to choose the Part you want to modify.

The button indicator of the selected Part will light and the Part number and the Patch name assigned to the Part will be displayed at display upper right.

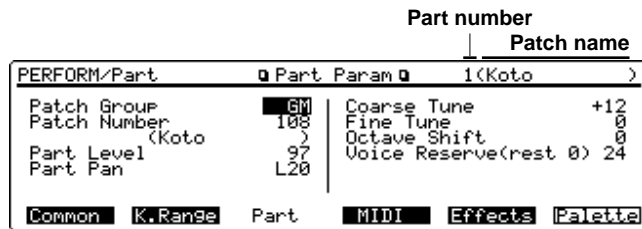

- * If you have selected [F1] (Common) in step 1, your editing will modify a parameter that's common to the entire Performance so you can't pick any specific Part to modify.
- ❹ Move the cursor to the parameter you wish to modify.
- ❺ Use the VALUE dial, [INC]/[DEC] or numeric keys to change the parameter value.
- * If you've made a mistake in setting the parameter value or you don't like the changes, press [UNDO/REDO] to restore the value to what it was.
- ❻ Repeat steps 1–5 to complete a Performance.
- ❼ When you finish making settings, press [EXIT] or [PERFORM] to return to the Play display (PERFORM).

An asterisk (*) will be displayed at the left of the Performance group to indicate Performance settings have been modified.

- * If you select another Performance in the group with an asterisk (*), the modified Performance settings will be lost. To keep these modified settings, you must write them into user memory (p.46).

Editing a Performance using Palette display

You can also edit a Performance using the Palette display in Performance mode. When modifying Part settings for a Performance, the values for eight Parts (Part 1–8 or Part 9–16) will be displayed together on a single display. This is useful when you wish to change parameter values while comparing each Part settings.

<Procedure>

- ❶ When modifying a Part, press [F6] (Palette) to call up the Palette display.
- * You can press [F6] (Palette) only when the Palette display can be active.

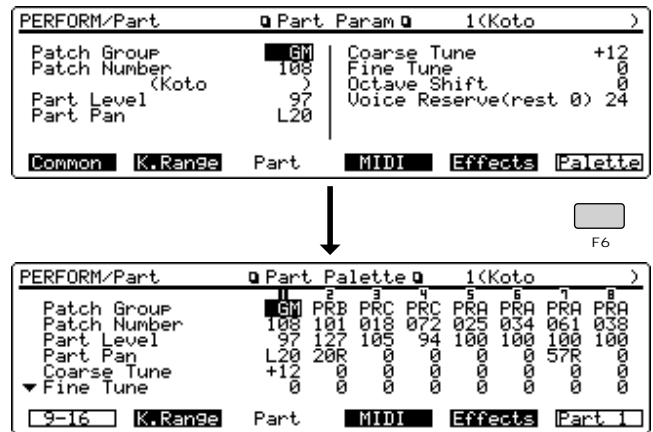

- ❷ Press a TRACK/PART [1]–[16] button or [◀] and [▶] to choose the Part you want to modify.

The button indicator of the selected Part will light and the Part number and the Patch name assigned to the Part will be shown at display upper right.

- * To call up the Palette display for Parts 9–16 when the Part 1–8 Palette is on display, press [F1] (9-16). Press [F1] (1-8) for vice versa.
- ❸ Press [▲] or [▼] to move the cursor to the parameter you want to modify.
- ❹ Use the VALUE dial, [INC]/[DEC] or numeric keys to change the parameter value.
- * If you've made a mistake in setting the parameter value or you don't like the changes, press [UNDO/REDO] to restore the value to what it was.
- ❺ Repeat steps 1–4 to configure a Performance.
- ❻ To exit the Palette display, press [F6].

The Part number to which the display will return will be indicated for [F6].

Modifying the Patch assigned to a Part

When using Patches in Performance mode, some settings such as effects settings will be affected by Performance settings. If you wish to edit a Patch while hearing how it will sound in the Performance, use this procedure:

<Procedure>

- ❶ Make sure that the Play display (PERFORM) is showing.
- ❷ Press [◀] or [▶] to select the Part to which the selected Patch is assigned.
- ❸ While holding down [PERFORM], press [PATCH] or press [▼]. This will call up the Play display of the Patch assigned to the currently selected Part.

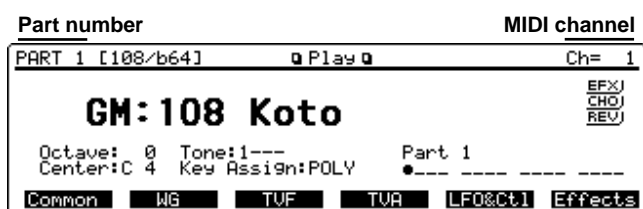

- ❹ The following steps are the same as when you modify a Patch in Patch mode.
- ❺ When you finish making settings, press [EXIT] to call up the Play display of the Patch assigned to the Part.

An asterisk (*) will be displayed at the left of the Patch group. This indicates the Patch settings have been modified.

- ❻ To return to the Play display (PERFORM), press [▲], [PERFORM] or [EXIT].
- * If you select another Patch in the group with an asterisk (*), the modified Patch settings will be lost. To keep these modified settings, you must write them into user memory (p.46).

Editing a Rhythm Set

You can change the percussion instrument assigned to each key. As each percussion instrument consists of a single Rhythm Tone, there is no Palette display.

<Procedure>

- ❶ In the Play display (RHYTHM), press a button from [F1] (Common)–[F6] (Effects) to choose the display group you want.
- ❷ Press a [F1]–[F6] button to call up the desired display page.
- ❸ If you have pressed any of [F2] (WG)–[F5] (Key Ctl) in step 1, press a key (on the keyboard) to select the Rhythm Tone you want to modify.

The selected key (Note name) and Wave name will be displayed at display upper right.

- * It is also possible to select a note (Rhythm Tone) by pressing TONE SELECT [1]–[4] (BANK [5]–[8]).

TONE SELECT 1 (BANK [5]): selects a 1-octave lower note.

TONE SELECT 2 (BANK [6]): selects a semitone-lower note.

TONE SELECT 3 (BANK [7]): selects a semitone-higher note.

TONE SELECT 4 (BANK [8]): selects a 1-octave higher note.

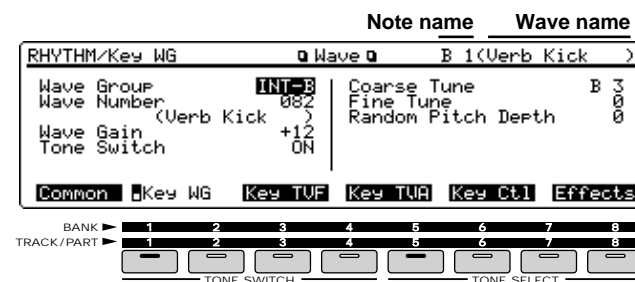

- ❹ Move the cursor to the parameter you want to modify.
- ❺ Use the VALUE dial, [INC]/[DEC] or numeric keys to modify the parameter value.
- * If you've made a mistake in setting the parameter value or you don't like the changes, press [UNDO/REDO] to restore the value to what it was.
- ❻ Repeat steps 1–5 to configure a Rhythm Set.
- ❼ When you finish making settings, press [EXIT] or [RHYTHM] to return to the Play display (RHYTHM).

An asterisk (*) will be displayed at the left of the Rhythm Set group. This indicates that the Rhythm Set settings have been modified.

- * If you select another Rhythm Set in the group with an asterisk (*), the modified Rhythm Set settings will be lost. To keep these modified settings, you must write them into user memory (p.46).

Keeping edited sound

Memory and data storage

The location where Patch and Performance settings, etc. are stored is 'memory.' There are three memory types: temporary memory, rewritable memory and non-rewritable memory.

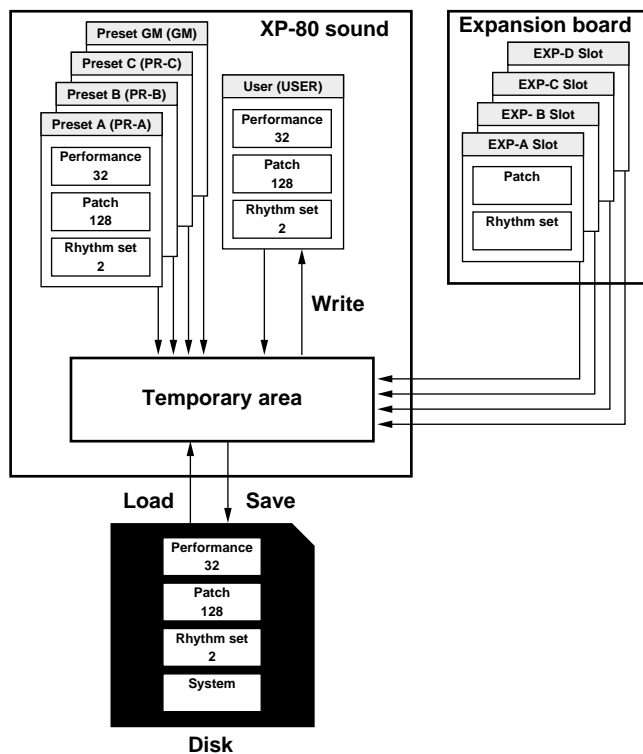

Temporary memory

Temporary area

This area holds data for the Performance, Patch, and Rhythm Set you select using the front panel buttons, etc. When you play the keyboard or play back a sequence, sound is produced based on data in the temporary area. When you modify a Performance, Patch or Rhythm Set, you are modifying the data that has been called into the temporary area instead of the data in memory.

Settings in the temporary area are temporary, and will be lost when the power is turned off or when you select another Performance/Patch/Rhythm Set. To keep the settings you have modified, you must write them into rewritable memory.

Rewritable memory

System memory

System memory stores system parameter settings that determine how the XP-80 functions. When you modify these settings, the system memory settings are rewritten directly. These settings are non-volatile, being retained even when the power is turned off.

User memory

User memory contains data for 32 Performances, 128 Patches and two Rhythm Sets.

Disk (optional: 3.5" 2DD, 2HD)

A diskette can contain a set of data for Patches, Performances and Rhythm Sets as well as System parameter settings. This set of data is called a 'data file.'

Non-rewritable memory

Preset memory

Data in Preset memory (Patch: PR-A-C, GM, Performance: PR-A-B, Rhythm Set: PR-A-C, GM) cannot be rewritten. However, you can call up settings from preset memory into the temporary area, modify them and then store the modified data in rewritable memory.

Wave Expansion Boards (optional: SR-JV80 series)



Up to four Wave Expansion Boards can be installed in EXP-A-D Slots in the XP-80. Wave Expansion Boards contain Wave data, as well as Patches and Rhythm Sets that use this Wave data, which can be called directly into the temporary area and played.

- * When playing a Patch or Rhythm Set that use the Wave data from a Wave Expansion Board, the appropriate Wave Expansion Board must be installed in the XP-80 for the sound to play correctly.

<Installing a Wave Expansion Board>

To install an optional Wave Expansion Board (SR-JV80 series), the unit's bottom cover must be removed. For details refer to the instructions included with the Wave Expansion Board. Here are some precautions when installing a Wave Expansion Board into the XP-80.

There are four slots (EXP-A-D) into which a board can be installed. Slots EXP-A-D correspond to the group (XP-A-XP-D) you need to select in order to use a Wave, Patch or Rhythm Set from the Wave Expansion Board.

- * Always turn the unit off and unplug the power cord before attempting installation of the board. 
- * Install only the specified boards. Remove only the specified screws. 
- * Be careful not to cut your hand on the edges of the slot opening when installing a board.
- * To avoid the risk of damage to internal components that can be caused by static electricity, please carefully observe the following whenever you handle the board.
 - Before you touch the board, always first grasp a metal object (such as a water pipe), so you are sure that any static electricity you might have been carrying has been discharged.
 - When handling the board, grasp it only by its edges. Avoid touching any of the electronic components or connectors.
- * Do not touch any of the printed circuit pathways or connection terminals.
- * Never use excessive force when installing a board. If it doesn't fit properly on the first attempt, remove the board and try again.
- * When the board installation is complete, double-check your work.

Storing a sound you modify into user memory

The modified settings you make are only temporary, and will be lost if you turn the power off or select another Patch, Performance or Rhythm Set. To keep the modified settings, you must write them into user memory.

<Procedure>

❶ In Patch mode (when storing a Patch), Performance mode (when storing a Performance) or in Rhythm Set mode (when storing a Rhythm Set), press [UTILITY]. The Utility Menu display (UTILITY/Menu) will appear.

❷ Press [1] of the numeric keys, then [ENTER].

The Write display (UTILITY/Write) will appear.

❸ Use the VALUE dial, [INC]/[DEC] or numeric keys to specify the Patch, Performance or Rhythm Set number of the destination of writing.

❹ Press [F6] (Execute) to execute writing.

If Write Operation parameter (UTILITY/Protect/User Memory Protect) is OFF, the specified Patch, Performance or Rhythm Set will be overwritten by your new edited settings.

* If Write Operation parameter (UTILITY/Protect/User Memory Protect) is ON, the window will open. Change the ON setting to OFF, and you'll be ready to write your data into user memory. Press [EXIT] to close the window and then press [F6] (Execute) again to execute writing.

Functions of Patch parameters

Settings common to the entire Patch (Common)

Common General display

On this display you can assign a name to a Patch and set the volume and pan of the entire Patch.

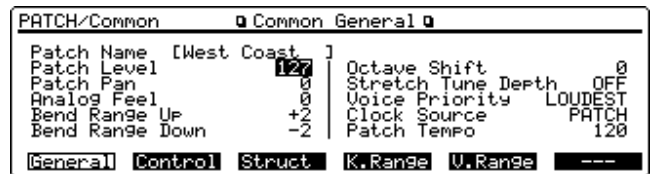

Patch Name

You can call the Patch any name of up to 12 alphanumeric characters.

Patch Level

Adjust the Patch's volume level. The Tone Level parameter (PATCH/TVA/TVA Param) lets you level each Tone.

Patch Pan

Places or pans the Patch to a desired point in the stereo soundfield. L64 is hard left, 0 is center, and 63R is hard right. The Tone Pan parameter (PATCH/TVA TVA Param) lets you pan each Tone.

Analog Feel (Analog feel depth)

Adjusts the depth at which 1/f modulation is applied to the Patch.

<1/f modulation>

'1/f' is a mathematical ratio that expresses the amount of 'predictable randomness' occurring in natural sounds that sound pleasing to the human ear, such as gentle breezes or murmuring brooks. The XP-80 can modulate the pitch and volume of sounds by this ratio to create the warmth that analog synthesizers have.

Bend Range Up

Specifies the degree of pitch change (in semitones) when the Bender lever is all the way right. When set to 12 and the Bender is fully at right, the pitch will go up 1 octave.

Bend Range Down

Specifies the degree of pitch change (in semitones) when the Bender lever is all the way left. When set to 48 and the Bender is fully at left, the pitch will go down 4 octaves.

Octave Shift

Specifies transposing a Patch in 1 octave units (-3- +3 octaves).

Stretch Tune Depth

Selects a stretch tuning curve. The curve selected decides how the notes of a chord will sound. The diagram below shows available tuning curves. The horizontal axis represents the scale, and the vertical axis represents the pitch difference relative to equal temperament. When this parameter is OFF, the notes of the keyboard will be in mathematically equal temperament. With a setting of 3, the high and low note ranges will be stretched to the maximum possible.

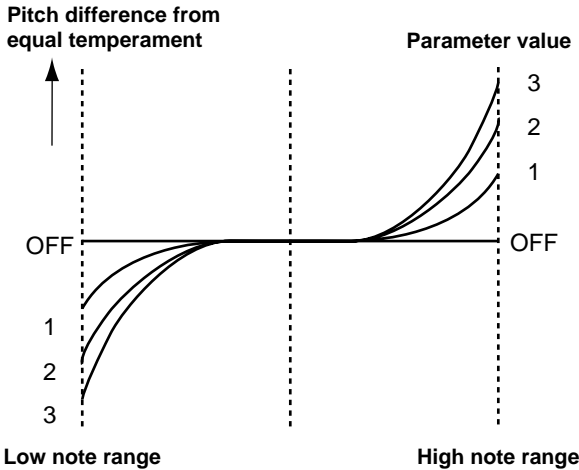

<Stretched tuning>

Acoustic pianos are normally tuned for a slightly flatter low note range and a slightly sharper high note range compared to a mathematically calculated equal temperament (i.e., octave precisely doubles the frequency of the previous octave). This tuning is most often used compared to any other simply because pianos sound better and richer when stretch-tuned.

Voice Priority

Specifies which currently played notes take priority when notes turned off to accommodate newly requested notes when the limits of 64 simultaneous voices are exceeded.

LAST: Latter played notes take priority. When the 65th voice is requested, the first notes currently being sounded will be turned off.

LOUDEST: Louder notes take priority. When the 65th voice is requested, the softest notes currently being sounded will be turned off.

Clock Source (Patch clock source)

Some parameters let you set a time value in terms of a note length which is determined by a tempo setting or tempo source you specify (reference tempo). Such parameters include Rate parameter (PATCH/LFO&Ctl/LFO1,2 Param), Time parameter (PATCH/WG/Wave Param), and some EFX parameters. The reference tempo can be set for each Patch. Select the tempo source for synchronization.

PATCH: Synchronizes to the Patch Tempo setting.

SEQUENCER: Synchronizes to the tempo clock of the sequencer.

* When syncing to the tempo clock of external devices, set the Clock Source to SEQUENCER and Sync Mode (SEQUENCER/Setup/SEQ System Setup) to SLAVE.

Patch Tempo

Set the Patch tempo.

* The Patch tempo clock is a reference for controlling Rate parameter (PATCH/LFO&Ctl/LFO1, 2 Param), Time parameter (PATCH/WG/Wave Param) and some EFX parameters, and does not transmit clock messages from MIDI OUT connector.

Common Control display

This display lets you specify controller function.

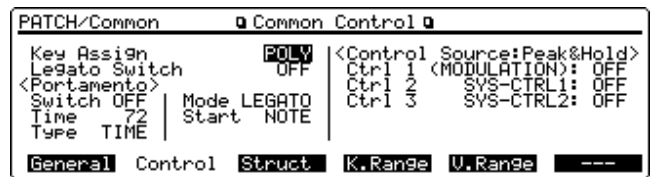

Key Assign

Specifies how notes will be played. When playing a solo instrument Patch (such as sax or flute), setting this parameter to SOLO is recommended. This setting also appears on the Play display (PATCH).

POLY: Two or more notes will be played simultaneously.

SOLO: Only one note will sound at a time.

* Pressing [SOLO] to light its indicator selects SOLO, and pressing it again to turn its indicator off selects POLY.

Legato Switch (Solo legato switch)

The Solo Legato function works only when the Key Assign parameter is set to SOLO. Turn this parameter ON when you use Solo Legato and OFF when you don't.

With the Legato Switch parameter ON, pressing a key while continuing to press a previous key causes the note to change pitch to the pitch of the most recently pressed key, sounding all the while. This is useful when you want to simulate playing techniques such as a guitar hammer-ons and pull-offs.

<Portamento>

Portamento makes a smooth pitch transition from one note to the next note played. With the Key Assign parameter set to SOLO, portamento is especially effective when simulating playing techniques such as a violin glissandos.

Switch (Portamento switch)

Set this parameter ON for using Portamento.

* Turning [PORTAMENTO] on/off will also change this parameter's setting.

Time (Portamento time)

Adjusts the changeover time for one pitch to change into the new pitch. The higher the setting the longer the time.

Type (Portamento type)

Selects the Portamento effect wanted.

RATE: Pitch change time varies in relation to the pitch difference.

TIME: Pitch change time stays constant, regardless of pitch difference.

Mode (Portamento mode)

Selects how Portamento is to be applied.

NORMAL: Portamento will always be applied.

LEGATO: Portamento effects only legato notes (i.e., when you press one key before releasing the previously pressed key).

Start (Portamento start pitch)

Starts a new portamento if you press another key during pitch change. This setting specifies the pitch where the new portamento starts.

PITCH: Starts a new portamento when another key is pressed while the pitch is changing.

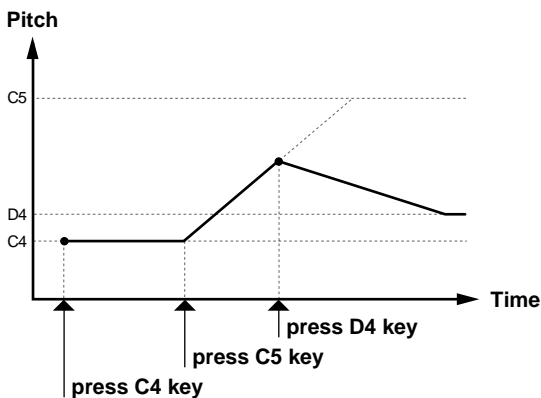

NOTE: A new portamento starts from the pitch change destination.

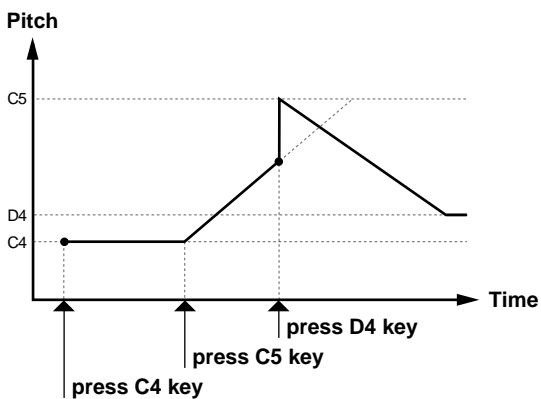

<Control Source>

You can use controllers to control a specific Tone parameter for each Patch, assigning functions that are different from those offered by conventional controllers to a controller. For example, changing Tone pitch by holding down a key (after-touch) or TVF resonance through the Pitch Bend lever.

Each Patch can have up to three controller assignments (Ctrl 1-3), and you can assign the following controllers to Control Source. The Control Source for Ctrl 1 is fixed at MODULATION.

OFF: A controller will not be used.

SYS-CTRL1: System controller 1

SYS-CTRL2: System controller 2

MODULATION: Modulation (Controller number 1)

BREATH: Breath (Controller number 2)

FOOT: Foot (Controller number 4)

VOLUME: Volume (Controller number 7)

PAN: Pan (Controller number 10)

EXPRESSION: Expression (Controller number 11)

PITCH BEND: Pitch bend

AFTERTOUC: Aftertouch

LFO1: Adjusts the modulation rate of the LFO1 waveform -Rate parameter (PATCH/LFO&Ctl/LFO 1 Param)

LFO2: Adjusts the modulation rate of the LFO2 waveform -Rate parameter (PATCH/LFO&Ctl/LFO 2 Param)

VELOCITY: Velocity

KEYFOLLOW: Adjusts parameter value depending on the key position, relative to the C4 key (0)

PLAYMATE: Adjusts parameter value depending on the time duration of the key press

* If you want to use a controller that is common to all Patches, or to use a controller that is not available for selection here, first select SYS-CTRL1 or SYS-CTRL2 for Control Source, then use the Sys-Ctrl1 parameter (SYSTEM/Control/Control Assign) or Sys-Ctrl2 parameter (SYSTEM/Control/Control Assign) to select the controller.

* Set the Tone parameter to be modified and its value on the Control Param display (PATCH/LFO&Ctl) (p.58).

<Peak&Hold>

Pedal messages conventionally hold only note- not MIDI messages like modulation and aftertouch. This makes it impossible to hold a sound (using a hold pedal) with aftertouch applied as you play the phrase.

The XP-80 can hold parameter value changes (maximum change value) even when the controller is returned to its original position after receiving pedal messages.

Use Peak&Hold to specify how parameter values will be held after receiving pedal messages.

OFF: Parameter values will not be held even if pedal messages are received.

HOLD: Parameter values will be held when pedal messages are received.

PEAK: Parameter values will be held when pedal messages are received. But if a parameter value greater than the current one is received while Hold is still ON, the new value will be held.

* When using this function, make sure you also set the Hold-1 parameter (PATCH/LFO&Ctl/Control Switch) ON.

- * If HOLD is selected for Peak&Hold, you must also set the Hold parameter (SYSTEM/Control/Control Source) to the type of pedal message to be controlled.
- * If PEAK is selected for Peak&Hold, you must also set the Peak parameter (SYSTEM/Control/Control Source) to the type of pedal message to be controlled.

Ctrl 1 (Controller 1)

Ctrl 1 uses Modulation to control a specific Tone parameter. Select how parameter values will be held using Peak&Hold.

Ctrl 2 (Controller 2)

Select the controller to control Ctrl 2 parameter with Control Source. Select how parameter values will be held using Peak&Hold.

Ctrl 3 (Controller 3)

Select the controller to control Ctrl 3 parameter with Control Source. Select how parameter values will be held using Peak&Hold.

Structure display

Use this display to determine how Tones are combined.

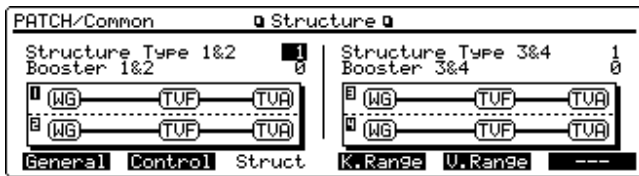

**Structure Type 1&2
Structure Type 3&4**

Each of the above two parameters determines how Tone 1 and 2, and Tone 3 and 4 are connected. Ten structures are available.

- * Space limitations make these symbols B: Booster and R: Ring Modulator necessary.

TYPE1: This keeps Tone 1 and 2 (or 3 and 4) independent of each other. Select this when you want to preserve PCM sounds or create new sounds and combine them for each Tone.

TYPE2: Two filters combine to enhance filter response. The TVA for Tone 1 (or 3) controls the volume balance between the two Tones.

TYPE3: Filters the mix of Tone 1 (or 3) and Tone 2 (or 4), before sending the signal through a booster to distort the waveforms.

TYPE4: Two filters combine and a booster is applied to distort waveforms. The TVA for Tone 1 (or 3) controls the volume balance between the two Tones and adjusts booster level.

TYPE5: Combines two filters and boosts the upper harmonics by processing with the ring modulator. The TVA for Tone 1 (or 3) is used to adjust ring modulation depth.

TYPE6: Combines two filters, boosts harmonics by ring modulation and mixes in Tone 2 (or 4). As the sound from the ring modulator and Tone 2 (or 4) can be mixed, the TVA for Tone 1 (or 3) adjusts the amount of ring-modulated sound.

TYPE7: Sends Tone 1 (or 3) which has been filtered and Tone 2 (or 4) through the ring modulator to boost harmonics.

TYPE8: Sends Tone 1 (or 3) which has been filtered and Tone 2 (or 4) through the ring modulator, then mixes it with the filtered Tone 2 (or 4).

TYPE9: Sends the filtered Tones through the ring modulator to boost the harmonics. The TVA for Tone 1 (or 3) controls the volume balance between the two Tones and adjusts ring modulation depth.

TYPE10: Sends the filtered Tones through the ring modulator to boost harmonics, then mixes the result with Tone 2 (or 4). As the sound from the ring modulator can be mixed with Tone 2 (or 4), the TVA for Tone 1 (or 3) adjusts the amount of ring-modulated sound.

- * In a selection of TYPE2–10, turning off one Tone will make the other Tone have a TYPE1 structure.

Booster 1&2 (Booster gain 1&2)

Booster 3&4 (Booster gain 3&4)

If TYPE3 or TYPE4 is selected for the Structure Type parameter, you can adjust the degree of Boost. The Booster amplifies the incoming signal to distort it, an effect like the distortion used with electric guitars.

<Booster>

The Booster is used to distort the incoming signal.

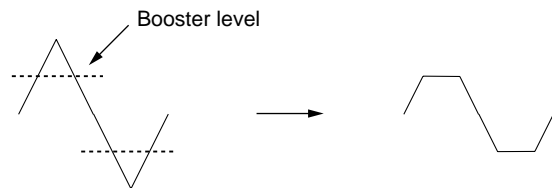

You can also create a PWM (Pulse Width Modulation) like effect by using a Tone's waveform (WG1) as an LFO to shift the other Tone's waveform (WG2) up and down. This parameter works best when you use it in conjunction with the Gain parameter (PATCH/WG/Wave Param).

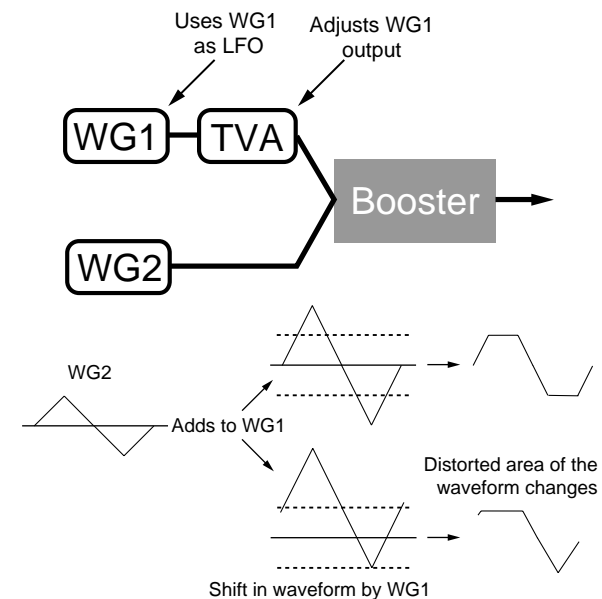

.....
 <Ring Modulator>

The Ring Modulator multiplies the waveforms of two Tones, creating a new sound that includes many harmonics (inharmonic partials) not present in the two original Tones. (As long as one Tone's waveform is not a sine wave, virtually no frequency components sound at regular intervals). As the pitch difference between the two waveforms changes the harmonic structure, the result will be an unpitched metallic sound. This is especially suitable for creating bell and other metallic sounds.

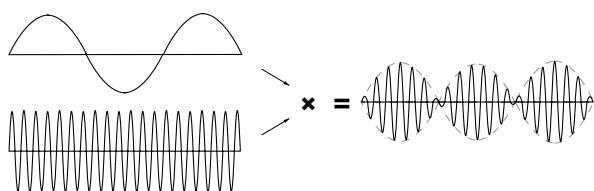

Tone Key Range Lower: Upper display

On this display, you can specify the range of notes that will play each Tone. This can be used to make notes in different areas of the keyboard play different Tones. The specified range is displayed graphically.

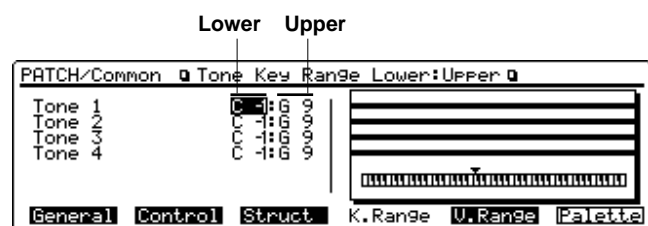

- Tone 1 (Tone 1 key range lower:upper)
- Tone 2 (Tone 2 key range lower:upper)
- Tone 3 (Tone 3 key range lower:upper)
- Tone 4 (Tone 4 key range lower:upper)

Lower specifies the lowest note to play each Tone and Upper specifies the highest, over the C-1 to G9 range.

- * You cannot set Lower to a value greater than Upper, or Upper to a value smaller than Lower. If you should do this by mistake, the two values will change together. If this is the case, reset the value.
- * If you have used [+OCT] or [-OCT] or the Transpose parameter (SYSTEM/Setup/Setup) to transpose the pitch of the XP-80's keyboard, the keyboard area specified by Key Range will also shift.

Tone Vel Range Lower:Upper:Fade (Tone velocity range) display

Here you can specify the range of velocities that will play each Tone. You can make different velocities play different Tones. The specified range is displayed graphically.

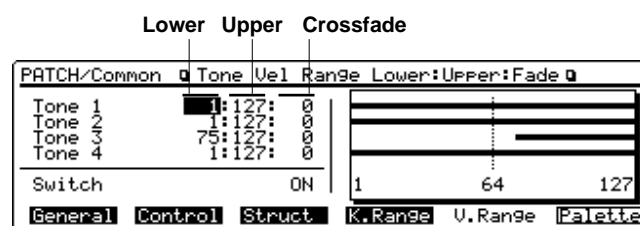

- Tone 1 (Tone 1 velocity range lower:upper:crossfade)
- Tone 2 (Tone 2 velocity range lower:upper:crossfade)
- Tone 3 (Tone 3 velocity range lower:upper:crossfade)
- Tone 4 (Tone 4 velocity range lower:upper:crossfade)

Lower specifies the lowest velocity limit to play each Tone, over the range of 1 to 127. Notes played softer than the set limit will not sound at all or be hardly audible.

Upper specifies the highest velocity limit to play each Tone, over the range of 1 to 127. Notes played more stronger than the set limit will not sound at all or be hardly audible.

Crossfade specifies how the volume of the Tone changes when the velocity of a note is outside the specified velocity range. Higher settings will result in a more gradual attenuation. If you don't want the Tone to sound at all for velocities outside the specified range, set this parameter to 0.

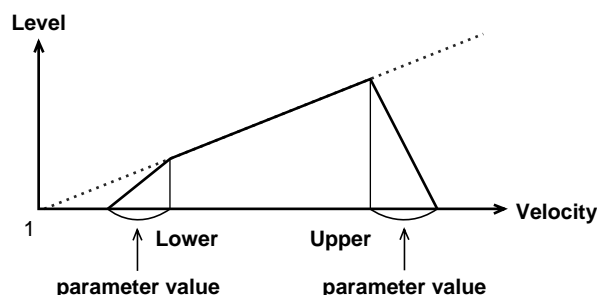

- * Lower cannot have a value greater than Upper, or Upper any value smaller than Lower. If you should do this by mistake, the two values will change together. If this is the case, reset the value.

Switch (Velocity range switch)

Specifies if the velocity range setting will be used or not. The velocity range setting is used when the Switch parameter is ON.

Modifying waveform and pitch (WG)

Wave Param (Wave parameter) display

Selects the basic sound source waveform for a Tone and modify it.

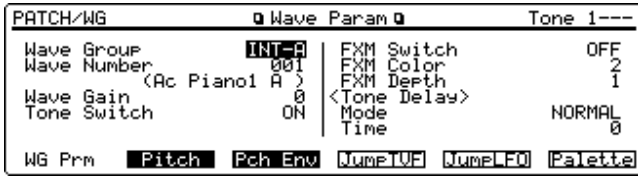

Wave Group

Selects the waveform group.

INT A-B: Waveform stored in the internal memory

EXP A-D: Waveform stored in Wave Expansion Board installed in EXP-A-D slots

- * To display the waveform list, press [SOUND LIST].
- * You cannot select a waveform group of a Wave Expansion Board which is not installed.

Wave Number

Selects the basic waveform for a Tone. The name of the wave will be displayed in parentheses ().

- * To display the waveform list, press [SOUND LIST].

Wave Gain

Adjusts the gain of the wave to boost it. The range is -6- +12 dB, in steps of 6 dB. An increase of 6 dB doubles the gain. If you use Booster to distort the sound, turn this right up!

Tone Switch

Turn it on when you want a specific Tone. Keep it OFF otherwise. This allows you to make best use of the available number of simultaneous voices because unused Tones can be turned off.

- * When you use TONE SWITCH [1] -[4] buttons to turn a Tone on/off, this parameter setting will also change accordingly.

<FXM (Frequency Cross Modulation)>

FXM applies frequency modulation by adding a specific waveform to the original waveform to create new and more complex harmonic components. It really helps when you want to create radical sounds or effects.

FXM Switch

Set it ON for using the FXM, otherwise keep it OFF.

FXM Color

Selects one of four different types for FXM frequency modulation method. Higher settings will result in a grainier sound and lower settings will result in a more metallic sound.

FXM Depth

Adjusts frequency modulation depth created by the FXM.

<Tone Delay>

This parameter delays the time from when a key is pressed (or released) to when the Tone actually sounds. Since you can change the timing of each Tone to sound, you can create effects not possible with conventional delay units. For instance, you can change the sound for a Tone to be delayed or can play an arpeggio simply by pressing a single key if you've assigned a different pitch to each Tone.

You can also sync delay time to the XP-80's sequencer or MIDI clock of an external device.

- * If you are not going to use Tone Delay, set the Mode parameter (discussed below) to NORMAL and Time parameter to 0.

Mode (Tone delay mode)

Selects delay type to be applied to each Tone.

NORMAL: The Tone will sound after the time specified with the Time parameter.

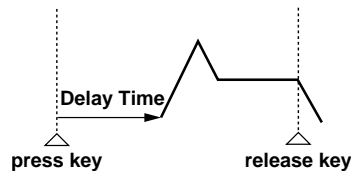

HOLD: If the key is pressed for a longer time than what you specified for the Time parameter, the Tone will sound after the delay time elapses. If the key is released earlier than the specified delay time, the Tone will not sound.

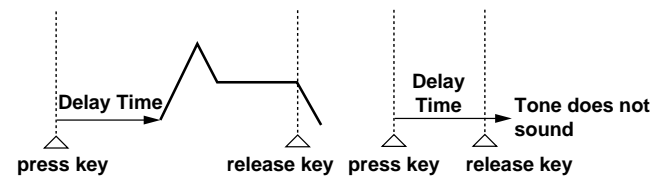

PLAYMATE: If less than 2 seconds elapse before pressing the next key, the Tone will sound after the time specified by the Time parameter. If 2 seconds or more elapse before you press the next key, the Tone will not sound.

CLOCK-SYNC: Syncs delay time to the Patch Tempo parameter setting (PATCH/Common/Common General) or Perform Tempo parameter setting (PERFORM/Common/Common), or the XP-80 sequencer's tempo clock.

If you want to use a fixed tempo in Patch mode (Patch Tempo parameter setting), set the Clock Source parameter (PATCH/Common/Common General) to PATCH and set the desired tempo.

If you want to use the sequencer's tempo clock in Patch mode, set the Clock Source parameter (PATCH/Common/Common General) to SEQUENCER.

If you want to use a fixed tempo in Performance mode (Perform Tempo parameter setting), set the Clock Source parameter (PERFORM/Common/Common) to PERFORM and set the desired tempo.

If you want to use the sequencer's tempo clock in Performance mode, set the Clock Source parameter (PERFORM/Common/Common) to SEQUENCER.

KEY-OFF-N: The Tone will not sound while the key is being pressed, but will sound after the Time parameter setting, if the key is released.



KEY-OFF-D: The Tone will not sound while the key is being pressed, but will sound after the Time parameter setting, if the key is released. Please remember that this setting allows the TVA envelope of the Tone to begin changing, so in most cases only the decay portion of the sound will be heard.



* If you have selected a decay type sound wave (i.e., a sound that fades naturally even if the key is not released), selecting KEY-OFF-N or KEY-OFF-D may result in no sound being produced.

TEMPO-SYNC: If you select a Wave with tempo (BPM) being displayed when an optional Wave Expansion Board such as the "SR-JV80-10: BASS & DRUMS" is installed, the Tone will synchronize to the tempo clock of the sequencer regardless of which key is pressed. This is most effective when playing phrase loops in sync with the tempo of a song (p.179).

If you want to sync to the tempo of a song in Patch mode, set the Clock Source parameter (PATCH/Common/Common) to SEQUENCER.

If you want to sync to the tempo of a song in Performance mode, set the Clock Source parameter (PERFORM/Common/Common) to SEQUENCER.

- * When TEMPO-SYNC is selected, pitch and FXM settings will be ignored.
- * When selecting TEMPO-SYNC, also set the Time parameter to 0. If other values are set, Tone Delay will be activated.

Time (Tone delay time)

Specifies the time that elapses from when the key is pressed (or from key release if KEY-OFF-N or KEY-OFF-D has been selected for the Mode parameter) to when the Tone will sound (using Tone Delay).

If PLAYMATE has been selected for the Mode parameter, a setting of 64 will set delay time to the interval between the previous Note On and the current Note On. To extend time about twice as long as a 64 setting, try 127. To cut the time by half, try setting it to 32. At a 0 setting, the Tone will not sound. For example, to make two notes sound (one note followed by the other) with one key, use two Tones and set one Tone's Time parameter to 0 and the other Tone's Time parameter to 32 or whatever delay you prefer.

If the Mode parameter is set to CLOCK-SYNC, the setting will be in quarter-note steps, and the corresponding note value symbol will also be displayed. This lets you specify the delay time in note length relative to synth tempo. For instance, if the tempo is 120 with resolution set to 96=♩, delay time will be 0.5 second. In other words, a tempo of 120 produces 120 quarter-notes per minute (60 seconds), so 60 divided by 120 equals 0.5 second.

* If Structure Type 1&2 (or 3&4) parameter (PATCH/Common/Structure) is set to Type2-10, the outputs of Tone 1 (or 3) and 2 (or 4) will be combined into Tone 2 (or 4). The settings of Tone 1 (or 3) will be ignored.

Pitch display

You can set the WG pitch of each Tone.

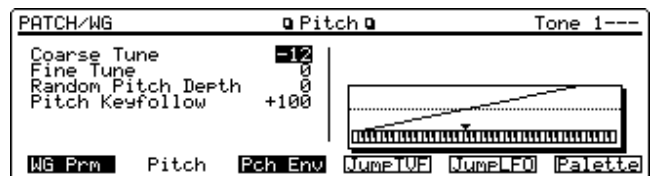

Coarse Tune

Adjusts pitch in semitone steps (-4- +4 octaves).

Fine Tune

Adjusts pitch in 1-cent (1/100th of a semitone) steps (-50- +50 cents).

Random Pitch Depth

For random pitch changes with every key press, use this parameter to set the desired amount (in cents) of pitch change. If you don't want random pitch changes set it to 0.

Pitch Keyfollow

Sets the amount of pitch change as you move 1 octave on the keyboard. The pitch change is displayed graphically.

For a conventional keyboard pitch change of 1 octave when keyboard position goes up 1 octave, set this parameter to +100. For a 2 octave pitch changes when keyboard position goes up 1 octave, set this parameter to +200. Negative (-) values will lower pitch even as you go up the keyboard. A setting of 0 makes all keys have the same pitch.

Pitch Envelope display

This is where to set the pitch envelope (how pitch changes over time) according to keyboard playing dynamics. The pitch envelope is displayed graphically.

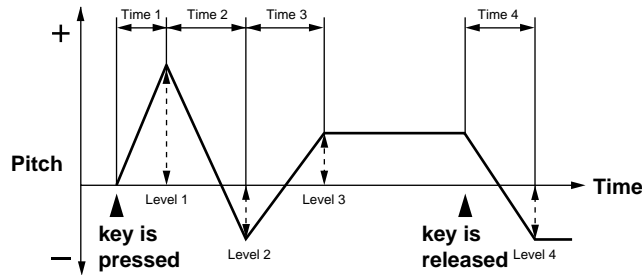
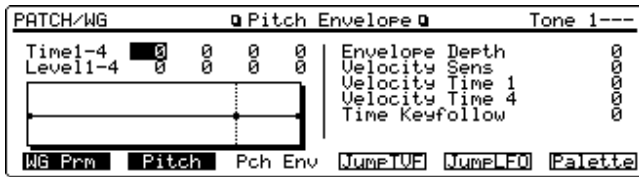

Time1-4 (Pitch envelope time 1-4)

Sets pitch envelope's time (Time 1-4). Higher settings extend the duration over which pitch changes from one point to another (for example, time for the pitch to change from Level 1 to Level 2 for Time 2).

Level1-4 (Pitch envelope level 1-4)

Sets pitch envelope level (Level 1-4) to determine pitch of each point relative to the reference pitch (pitch set for Coarse Tune or Fine Tune). Positive (+) values will raise pitch over the reference pitch, and negative (-) values lower pitch below the reference pitch.

Envelope Depth (Pitch envelope depth)

Adjusts pitch envelope amount. Higher settings produce more change. Negative (-) values invert the envelope.

Velocity Sens (Pitch envelope velocity sensitivity)

This parameter should be used when you want keyboard playing dynamics (velocity) to impact on pitch envelope amount. With positive (+) values, the amount of pitch envelope increases as the key is pressed with increasing force. Negative (-) values reduce pitch envelope amount as the key is pressed with increasing force.

Velocity Time 1 (Pitch envelope velocity time 1 sensitivity)

Use this parameter when you want keyboard playing dynamics (velocity) to impact on the Time1 parameter of the pitch envelope. With positive (+) settings, a higher keyboard velocity will reduce (speed up) Time1 value. With negative (-) settings, higher keyboard velocity will increase (slow down) Time1 value.

Velocity Time 4 (Pitch envelope velocity time 4 sensitivity)

Use this parameter when you want key release speed to impact on Time4 value of the pitch envelope. If you want a quicker release to reduce (speed up) Time4 value, use positive (+) values. For a quicker release to increase Time4 (slow down) value, use negative (-) settings.

Time Keyfollow (Pitch envelope time keyfollow)

Use this parameter when you want a pressed key to control pitch envelope time (Time2-Time4 parameter settings). Higher settings will have a greater time change relative to the envelope time at middle C (C4). Positive (+) settings will reduce the time when keys higher than middle C are pressed. Negative (-) settings will increase the time for notes higher than middle C.

Modifying the brightness of sound with a filter (TVF)

TVF Param (TVF parameter) display

This display is for TVF (Time Variant Filter) settings. By changing a sound's brightness or thickness, a Tone can be modified. Frequency characteristics of the filter are displayed graphically at screen lower left.

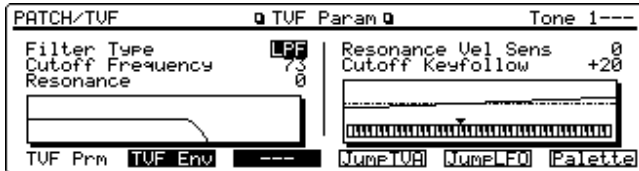

Filter Type

Selects the filter type. A filter attenuates a specific frequency range to modify the brightness or thickness of sound.

OFF: No filter is used.

LPF: Low Pass Filter cuts frequencies above the cutoff frequency to round off the sound. This is the most common filter used in synthesizers.

BPF: Band Pass Filter cuts frequencies below and above the cutoff frequency range. Most effective for creating sounds with strong characteristics.

HPF: High Pass Filter cuts the frequencies below the cutoff frequency. Suitable for creating percussive sounds emphasizing highs.

PKG: Peaking Filter emphasizes frequencies around the cutoff frequency. You can use this to create wah-wah effects by employing an LFO to change the cutoff frequency cyclically (p.58).

Cutoff Frequency

Sets the frequency at which the filter begins to have effect on the waveform's frequency components.

With LPF selected for the Filter Type parameter, lower Cutoff Frequency settings will reduce upper harmonics for a more rounded sound. Higher settings will make sound brighter.

If BPF is selected, harmonic components will change depending on the Cutoff Frequency setting. Using this parameter effectively will create some highly distinctive sounds.

With HPF selected, higher Cutoff Frequency settings will reduce lower harmonics to emphasize just the brighter components of the sound.

With PKG selected, the harmonics to be emphasized will vary depending on Cutoff Frequency setting.

Resonance

Emphasizes frequencies around the cutoff frequency. Excessive level at some settings can cause oscillation and distortion.

Resonance Vel Sens (Resonance velocity sensitivity)

Use this parameter if you want velocity to influence the Resonance parameter. If you want higher keyboard velocities to create more changes in Resonance, use positive (+) values. For less Resonance change, use negative (-) values.

Cutoff Keyfollow (Cutoff frequency keyfollow)

Use this parameter if you want the cutoff frequency to be influenced by the key pressed. Higher settings will increase change relative to middle C (C4). Positive (+) settings will make cutoff frequency rise as you play higher on the keyboard. Negative (-) settings will lower the cutoff frequency.

This setting is graphically displayed at screen lower right.

TVF Envelope display

This display is used for setting TVF envelope (how cutoff frequency changes over time). The TVF envelope is displayed graphically.

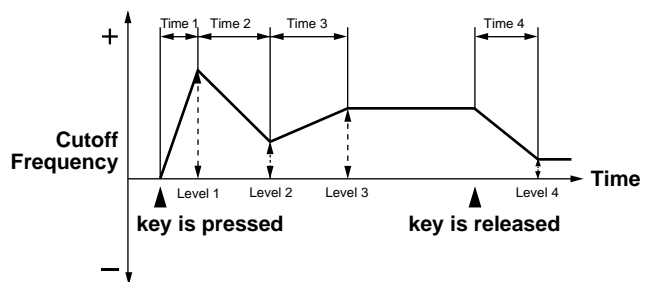
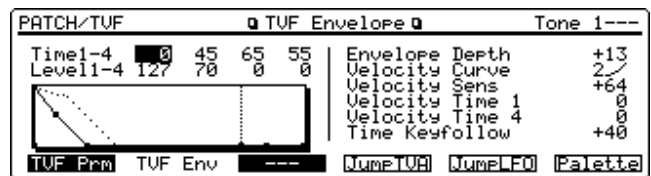

Time1-4 (TVF envelope time 1-4)

Sets TVF envelope time (Time 1-4). Higher settings will extend the time over which cutoff frequency changes from one point to the next point (for example, time during which the cutoff frequency changes from Level 1 to Level 2 for Time 2).

Level1-4 (TVF envelope level 1-4)

Sets the TVF envelope level (Level 1-4) to determine cutoff frequency of each point relative to the specified Cutoff Frequency parameter value.

Envelope Depth (TVF envelope depth)

Adjusts degree of TVF envelope. Higher settings result in more change. Negative (-) settings invert the envelope.

Velocity Curve (TVF envelope velocity curve)

Selects one of seven curves to set how keyboard playing dynamics (velocity) influences cutoff frequency. The selected curve is shown at the right of the number.

Velocity Sens (TVF envelope velocity sensitivity)

The parameter to use when you want keyboard playing dynamics (velocity) to affect TVF envelope amount. Positive (+) settings increase TVF envelope amount as a key is pressed harder. Negative (-) settings decrease TVF envelope amount when the key is pressed harder.

Velocity Time 1 (TVF envelope velocity time 1 sensitivity)

The parameter to use when you want keyboard playing dynamics (velocity) to affect Time1 parameter of the TVF envelope. At positive (+) settings, higher keyboard velocities will reduce (speed up) Time1 value.

At negative (-) settings, higher keyboard velocities will increase (slow down) Time1 value.

Velocity Time 4 (TVF envelope velocity time 4 sensitivity)

The parameter to use when you want key release speed to control the Time4 value of the TVF envelope. For a quicker release to reduce (speed up) the Time4 value, use positive (+) settings. To increase (slow down) Time4 value, use negative (-) settings.

Time Keyfollow (TVF envelope time keyfollow)

The parameter to use when you want key position to control the time of the TVF envelope (Time2–Time4 parameter settings). Higher settings produce more time change relative to the envelope time at middle C (C4). Positive (+) settings will reduce time when keys higher than middle C are pressed. Negative (-) settings will extend time.

Changing the sound's volume (TVA)

TVA Param (TVA Parameter) display

This display is used when setting volume for each Tone.

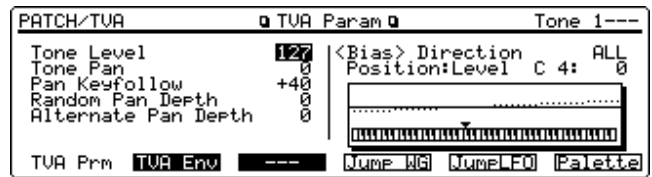

Tone Level

Adjusts the volume of each Tone. Use this parameter to adjust the volume balance between Tones as desired.

- * To set overall volume for a Patch, use the Patch Level parameter (PATCH/Common/Common General). The Tone Level parameter setting will be multiplied by the Patch Level value.

Tone Pan

Adjusts the pan (location in stereo soundfield) for each Tone. L64 pans hard left, 0 is center and 63R pans hard right.

- * To pan a complete Patch, use the Patch Pan parameter (PATCH/Common/Common General). The Tone Pan parameter setting will be added to the Patch Pan value.

Pan Keyfollow

Use this parameter if you want key position to affect panning. Higher values will have more pan relative to middle C (C4). Positive (+) settings will pan notes toward keyboard right when keys higher than middle C are pressed. Negative (-) settings will pan left.

Random Pan Depth

Use this parameter to select key-initiated random panning. Higher values result in greater panning.

Alternate Pan Depth

Use this parameter for key-initiated left/right alternate panning. Higher values result in greater panning. L or R values can be set, and these can be used to reverse the left/right panning order if desired. If you want to alternate the pan position of two Tones, set them to opposite L and R settings.

<Bias>

Set this parameter for key position to influence the Tone Level parameter. This is useful for changing volume through keyboard position (pitch) when playing acoustic instruments. The specified Bias curve is displayed graphically.

Direction (Bias direction)

Selects the direction in which the change will occur relative to the key set for the Position parameter.

LOWER: Changes the volume in the range below the key set for the Position parameter.

UPPER: Changes the volume in the range above the key set for the Position parameter.

LOW&UP: Changes the volume symmetrically in the ranges below and above the key set for the Position parameter.

ALL: A straightline volume change is created over the entire keyboard range, relative to the key set for the Position parameter.

Position:Level (Bias position: Bias level)

Use the Position parameter to select the key from which volume will begin to change.

Level parameter adjusts the volume change curve to occur in the direction determined by the Direction parameter. Higher values will result in a steeper curve. Negative (-) values will invert the change.

TVA Envelope display

This display is used when setting TVA envelope (how TVA level changes over time). The specified TVA envelope is displayed graphically.

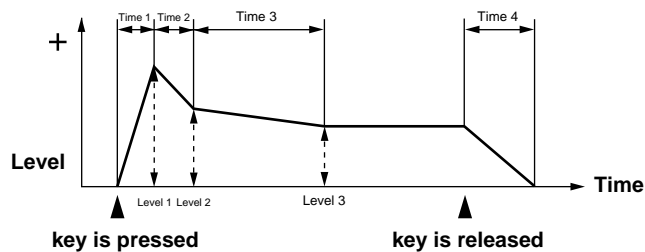

Time1-4 (TVA envelope time 1-4)

Sets TVA envelope time (Time 1-4). Higher settings will extend the time over which the volume changes from one point to the next (for example, duration for volume to change from Level 1 to Level 2 for Time 2).

Level1-3 (TVA envelope level 1-3)

Sets TVA envelope level (Level 1-3) to adjust the volume level of each point relative to the reference volume (specified Tone Level value).

Velocity Curve (TVA envelope velocity curve)

Selects one of seven curves to set how velocity (keyboard playing dynamics) influences TVA envelope amount. The selected curve is shown at the right of the number.

Velocity Sens (TVA envelope velocity sensitivity)

Use this parameter when you want velocity to influence TVA envelope amount. Positive (+) settings increase the amount of TVA envelope as the key is pressed with increasing force. Negative (-) settings do the reverse.

Velocity Time 1 (TVA envelope velocity time 1 sensitivity)

Use this parameter when you want velocity to influence the Time1 parameter of the TVA envelope. With positive (+) settings, greater keyboard velocities will reduce (speed up) Time1 value.

With negative (-) settings, greater keyboard velocities will increase (slow down) Time1 value.

Velocity Time 4 (TVA envelope velocity time 4 sensitivity)

Use this parameter when you want key-release speed to influence the Time4 value of the TVA envelope. For a quicker release to reduce (speed up) the Time4 value, use positive (+) settings. To increase (slow down) Time4 value, use negative (-) settings.

Time Keyfollow (TVA envelope time keyfollow)

Use this parameter for a key position to influence TVA envelope time (Time2-Time4 parameter settings). Higher settings result in a greater time change relative to the envelope time at middle C (C4). Positive (+) settings will reduce time when keys above middle C are pressed. Negative (-) settings will extend time.

Modulating sounds—Adding Vibrato, Tremolo, etc.

Using controllers to change how sounds are played (LFO&Ctl)

LFO1 Prm (LFO 1 parameter) display/LFO2 Prm (LFO2 parameter) display

An LFO (Low Frequency Oscillator) causes change over a cycle in a sound. Each Tone has two LFOs, and these can be used to cyclically change the pitch, cutoff frequency and volume to create modulation-type effects such as vibrato, wah-wah and tremolo. Both LFOs have the same parameters so only one explanation is needed.

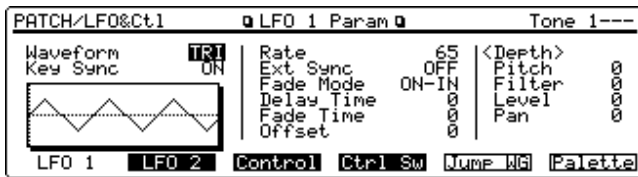

Waveform (LFO waveform)

Selects the waveform of the LFO. The selected waveform is graphically displayed.

TRI: Triangle wave

SIN: Sine wave

SAW: Sawtooth wave

SQR: Square wave

TRP: Trapezoidal wave

S&H: Sample and hold wave

RND: Random wave

CHS: Chaos wave

Key Sync (LFO key sync)

Specifies whether you want the LFO cycle to start in sync with the timing of a key press (ON) or not (OFF).

Rate (LFO rate)

Adjusts the modulation rate of the LFO waveform.

* If you have selected CHS (chaos waveform) for Waveform parameter, the Rate parameter setting has no effect.

* If you have set the Ext Sync parameter to CLK, this parameter will indicate a note value in multiples of a quarter note. The corresponding note value symbol is also displayed. This allows you to set the Rate parameter in terms of a note length in the sync tempo.

Ext Sync (LFO external sync)

Selects how the LFO is to be synchronized.

OFF: Unsynchronized.

CLK: Synchronizes the LFO delay time to the Patch Tempo parameter setting (PATCH/Common/Common General) or Perform Tempo parameter setting (PERFORM/Common/Common) or sequencer's tempo clock.

If you want to use a fixed tempo in Patch mode, set the Clock Source parameter (PATCH/Common/Common General) to PATCH and set the desired tempo.

If you want to use the sequencer tempo clock in Patch mode, set the Clock Source parameter (PATCH/Common/Common General) to SEQUENCER.

If you want to use a fixed tempo in Performance mode (Perform Tempo parameter setting), set the Clock Source parameter (PERFORM/Common/Common) to PERFORM and set the desired tempo.

If you want to use the sequencer tempo clock in Performance mode, set the Clock Source parameter (PERFORM/Common/Common) to SEQUENCER.

Fade Mode (LFO fade mode)

Selects how the LFO is to be applied.

ON-IN: The LFO will fade in after the key is pressed.

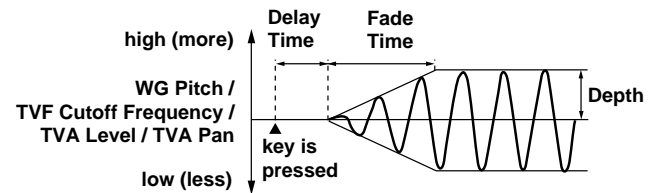

ON-OUT: LFO is applied immediately on key press then fades out.

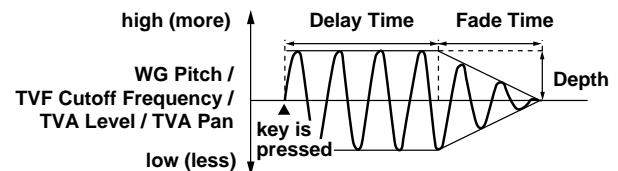

OFF-IN: LFO will fade in after key release.

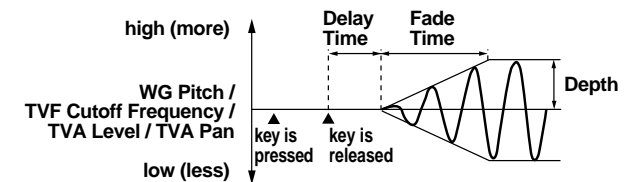

OFF-OUT: LFO is applied immediately when the key is pressed and will begin to fade out at key release.

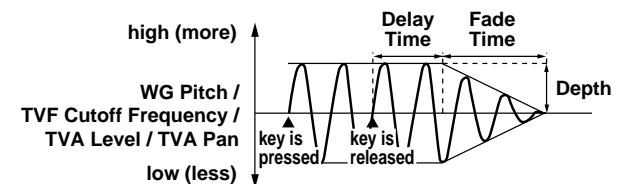

Delay Time (LFO delay time)

When the Fade Mode parameter is set to ON-IN, this parameter specifies the time from key press to when the LFO begins to take effect. When the ON-OUT is selected, this parameter sets the time over which the LFO continues to be active after key press.

When the Fade Mode parameter is set to OFF-IN, this parameter specifies the time from key release to when the LFO begins to take effect. When OFF-OUT is selected, this parameter sets the time over which the LFO continues to be active after key release.

Refer to the Fade Mode parameter diagrams.

Fade Time (LFO fade time)

Specifies time after the delay time until the LFO amplitude reaches maximum (or minimum).

Refer to the Fade Mode parameter diagrams.

Offset (LFO level offset)

Adjusts the LFO waveform up or down from the center value (pitch or cutoff frequency). Positive (+) settings will move the waveform up from the center value. Negative (-) settings will move it down from the center value.

<Depth (LFO depth)>

The Depth parameters adjust how LFO affects each parameter. Applying LFO to the pitch creates vibrato, applying it to the cutoff frequency will create a wah-wah effect, and applying it to the volume creates tremolo.

Pitch (Pitch LFO depth)

Adjusts degree to which LFO influences pitch.

Filter (Filter LFO depth)

Adjusts degree to which LFO influences cutoff frequency.

Level (Amplitude LFO depth)

Adjusts degree to which LFO influences volume.

Pan (Pan LFO depth)

Adjusts degree to which LFO influences panning.

* Pitch or volume changes reverse in relation from each other between positive (+) and negative (-) Depth parameter settings. Setting a Depth parameter to a positive (+) value for one Tone and setting another Tone with the same numerical value but negative (-), the modulation phase for the two Tones will be in reversed from each other. This allows you to shift back and forth between two different Tones and cyclically move the stereo soundfield position in combination with panning.

Control Param (Control parameter) display

Specifies Tone parameters to be controlled by the Ctrl 1-3 controllers specified on the Common Control display (PATCH/Common).

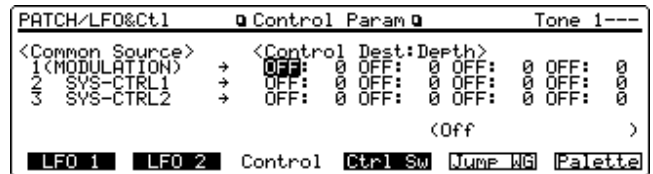

<Control Dest:Depth (Control destination: Control depth)>

Ctrl 1-3 can simultaneously control up to four parameters for each Tone.

For instance, filter opens by pressing down the key.

Open the Tone 1 filter with aftertouch.

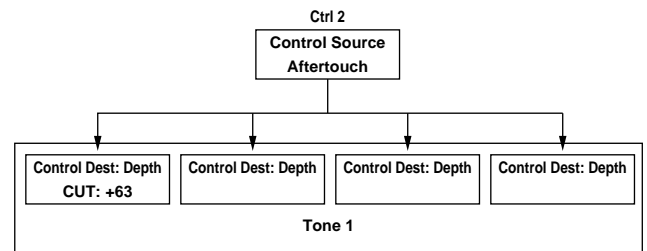

Use Control Dest to select the parameters to be controlled by Ctrl 1-3:

OFF: No control

PCH: Pitch

CUT: Cutoff frequency parameter (PATCH/TVF/TVF Param)

RES: Resonance parameter (PATCH/TVF/TVF Param)

LEV: Tone Level parameter (PATCH/TVA/TVA Param)

PAN: Tone Pan parameter (PATCH/TVA/TVA Param)

MIX: Mix/EFX Send Level parameter (PATCH/Effects/General)

CHO: Chorus Send Level parameter (PATCH/Effects/General)

REV: Reverb Send Level parameter (PATCH/Effects/General)

PL1: Vibrato depth-Pitch parameter (PATCH/LFO&Ctl/LFO1 Param)

PL2: Vibrato depth-Pitch parameter (PATCH/LFO&Ctl/LFO2 Param)

FL1: Wah-Wah effect depth-Filter parameter (PATCH/LFO&Ctl/LFO1 Param)

FL2: Wah-Wah effect depth-Filter parameter (PATCH/LFO&Ctl/LFO2 Param)

AL1: Tremolo depth–Level parameter (PATCH/LFO&Ctl/LFO1 Param)

AL2: Tremolo depth–Level parameter (PATCH/LFO&Ctl/LFO2 Param)

pL1: Depth of LFO1 applied to panning–Pan parameter (PATCH/LFO&Ctl/LFO1 Param)

pL2: Depth of LFO2 applied to panning–Pan parameter (PATCH/LFO&Ctl/LFO2 Param)

L1R: Modulation rate of the LFO1 waveform–Rate parameter (PATCH/LFO&Ctl/LFO1 Param)

L2R: Modulation rate of the LFO2 waveform–Rate parameter (PATCH/LFO&Ctl/LFO2 Param)

Depth parameter adjusts the degree of change applicable to the Tone parameters selected for the Control Dest. Higher values will cause more change. Negative (-) values will reverse the direction of change. For Rate parameter (PATCH/LFO&Ctl/LFO Param 1/2), negative (-) values will make modulation slower while positive (+) values will be faster.

* Tone parameter changes made with Ctrl 1–3 affect only the performance. They do not modify a Value of the tone parameter.

Ctrl 1 (Controller 1)

Control Dest specifies the four Tone parameters to be controlled by Ctrl 1 controller. Depth is used to adjust the degree of Tone parameter change.

* The Ctrl 1 controller is fixed at MODULATION.

Ctrl 2 (Controller 2)

Control Dest specifies the four Tone parameters to be controlled by Ctrl 2 controller. Depth is used to adjust the degree of Tone parameter change.

Use Control Source to set Ctrl 2 controller. This setting also changes the Control Source setting of the Ctrl2 parameter (PATCH/Common/Common Control).

Ctrl 3 (Controller 3)

Control Dest specifies the four Tone parameters to be controlled by Ctrl 3 controller. Depth is used to adjust the degree of Tone parameter change.

Use Control Source to set the Ctrl 3 controller. This setting also changes the Control Source setting of the Ctrl3 parameter (PATCH/Common/Common Control).

Control Switch display

On this display, you can specify whether you want each Tone to receive MIDI messages for volume, pan, pitch bend, etc.

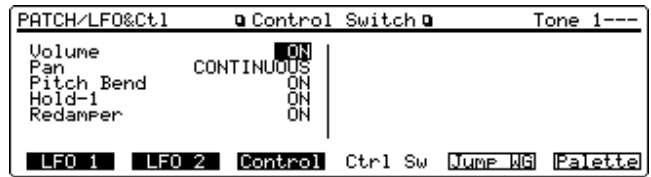

* Generally, volume messages control the volume, pan messages control stereo location and pitch bend messages control the pitch of the currently sounding note. However, the XP-80 allows these messages to control other specific tone parameters. Therefore, when you set any specific tone parameters to be controlled by such messages, make sure the respective control switch is OFF. If ON, the original functions of these MIDI messages will also be activated.

Volume (Volume control switch)

Set this ON when you want each Tone to receive volume messages. If not, set OFF.

Pan (Pan control switch)

Specifies how the pan messages are received.

OFF: Not received.

CONTINUOUS: Whenever pan messages are received, the stereo position of the note specified will be changed.

KEY-ON: The stereo position of a specific note is changed when the note is played. The stereo position of the specified note will not change until the next key press even if pan messages are received while it is being played. In this case, only the stereo position of the next played note will change, not the current note which is sounding.

Pitch Bend (Pitch bend control switch)

Set this ON when you want each Tone to receive pitch bend messages. If not, set OFF.

Hold-1 (Hold1 control switch)

Set this ON when you want each Tone to receive Hold1 messages. If not, set OFF.

Redamper (Redamper control switch)

If Hold1 messages are received during the time period from key release to sound decay, this parameter specifies whether or not to sustain the currently sounding note. If you want to sustain the sound, set this ON. When using this function, also set the Hold-1 parameter ON. This function is effective for piano sounds.

Setting effects for a Patch (Effects)

- * With the Arpeggiator on, closing the Arpeggio window in the Play display (PATCH) will assign the function to re-open the Arpeggio window to [F6]. To set effects parameters, hold down [SHIFT] as you press [F6] to call up the relevant display.

<Routing effects>

Deciding how you want the effects to be 'connected' (routing) depends mainly on how each Tone and effected sounds are output. Set the routing, then send level of the signal that is to be effected. At 0 level, nothing is sent and no effects are connected.

The first step is to configure effects routing on the General (Effects general) display. The basic procedure for deciding effects routing is discussed below.

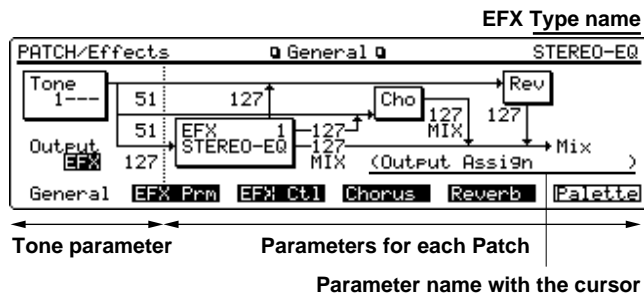

- * The graphic display as well as parameters on display will change with the settings.

(Basic Procedure)

- 1 Press [EFX], [CHORUS] and/or [REVERB] to turn on the effects you want.

Parameter settings have no effect unless you've turned on the effects you want.

- 2 Deciding Tone destination.

Use Output Assign to specify how each Tone is output. If you want each Tone to go through EFX, select EFX and use the Mix/EFX Send Level parameter to adjust Tone level.

- 3 Adjusting Chorus and/or Reverb amount.

Make your basic Chorus and Reverb settings for each Tone here.

For Chorus, set the Chorus Send Level parameter. Set it to 0 if you don't want this effect.

For Reverb, set the Reverb Send Level parameter. Set it to 0 if you don't want this effect.

- * Detailed settings such as how chorus is to sound or is output should be made on the Chorus display. Do the same for reverb type, reverb time, etc. on the Reverb display.

- 4 Selecting EFX type.

If you've selected EFX in step 2, use the EFX Type parameter to select EFX type.

- * Detailed settings for the EFX type you've selected should be made on the EFX Param display.

- 5 Adding chorus or reverb to a sound that's gone through EFX.

If you want to apply chorus and/or reverb to the sound after it's gone through the EFX, adjust the amount of chorus and or reverb using the EFX Chorus Send Level and EFX Reverb Send Level parameters. If not, set it to 0.

- 6 Deciding on the destination of sound that's gone through the EFX.

Use EFX Output Assign parameter to send it to the MIX OUTPUT jack or DIR OUTPUT jack.

- 7 Make fine adjustments for EFX, Chorus and Reverb to adjust the balance between these effects.

General (Effects general) display

Use this display to decide how effects are to be connected. Parameters on display differ with the Output Assign parameter setting.

- * If you have selected 2-10 for Structure Type 1&2 (or 3&4) parameters (PATCH/Common/Structure), Tone 1 (or 3) and Tone 2 (or 4) outputs are combined into Tone 2 (or 4). Tone 1 (or 3) settings will be ignored.

Output Assign parameter set to MIX

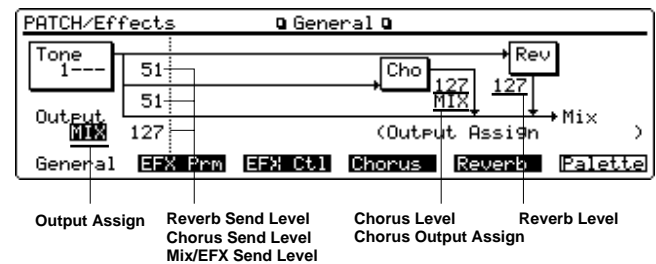

Output Assign

MIX: The direct sound is output to MIX OUTPUT jack. If Chorus and/or Reverb is selected, these effects are output together with the direct sound.

Reverb Send Level

Adjusts reverb intensity for each Tone.

Chorus Send Level

Adjusts chorus amount for each Tone.

Mix/EFX Send Level

Adjusts volume of each Tone.

Chorus Level

Adjusts volume level of chorus sound.

- * This setting also affects the Level parameter value (PATCH/Effects/Chorus).

Chorus Output Assign

Specifies how chorus sound is to be output.

MIX: The sound will be output from the MIX OUTPUT jacks just as it is.

REV: Reverb will be applied.

M+R: The sound will be output from the MIX OUTPUT jacks and to reverb.

* This setting also affects Output parameter (PATCH/Effects/Chorus) value.

Reverb Level

Adjusts the volume level of the reverb sound.

* This setting also affects Level parameter (PATCH/Effects/Reverb) value.

Output Assign parameter set to EFX

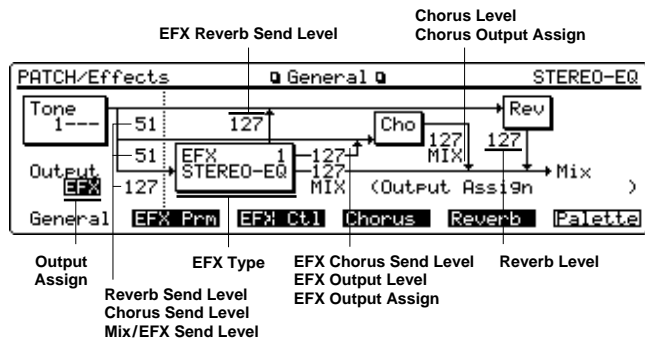

Output Assign

EFX: The direct sound is sent to EFX. After passing through EFX, the sound proceeds to the destination specified by the EFX OUTPUT Assign parameter.

Reverb Send Level

Adjusts reverb intensity for each Tone.

Chorus Send Level

Adjusts the amount of chorus for each Tone.

Mix/EFX Send Level

Adjusts the volume level of EFX'd sound for each Tone.

EFX Reverb Send Level

Adjusts reverb intensity applied to the sound that passes through EFX.

EFX Type

Select EFX type from the 40 types available. Set each EFX type's parameters on the EFX display (PATCH/Effects). For details, refer to "EFX effect types (EFX Parameter)" (p.74).

EFX Chorus Send Level

Adjusts the amount of chorus applied to the sound that passes through EFX.

EFX Output Level

Adjusts volume level of the output sound that passes through EFX.

EFX Output Assign

Specifies how the sound passing through EFX will be output.

MIX: The sound that passes through EFX will be output to the MIX OUTPUT jack. If Chorus and/or Reverb is selected, all these effects are output together with the direct sound.

DIR: The sound that passes through EFX will be output to the DIRECT OUTPUT jack. If Chorus and/or Reverb is selected, these settings have no effect.

Chorus Level

Adjusts volume level of chorus sound.

* This setting also affects the Level parameter (PATCH/Effects/Chorus) value.

Chorus Output Assign

Specifies how chorus sound is to be output.

MIX: The sound will be output from the MIX OUTPUT jacks just as it is.

REV: Reverb will be applied.

M+R: The sound will be output from the MIX OUTPUT jacks and to reverb.

* This setting also affects the Output parameter (PATCH/Effects/Chorus) value.

Reverb Level

Adjusts the level of the reverb sound.

* This setting also affects the Level parameter (PATCH/Effects/Reverb) value.

Output Assign parameter set to DIR

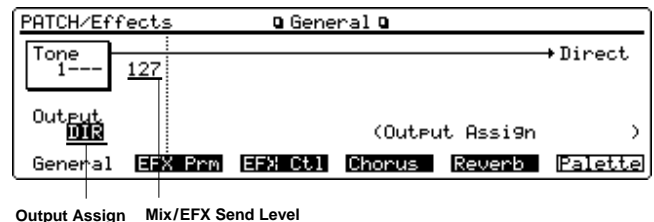

Output Assign

DIR: Only the direct sound will be sent to the DIRECT OUT jack. If Chorus and/or Reverb is selected, the effect settings have no effect.

Mix/EFX Send Level

Adjusts the volume level of each Tone.

.....
<Effects routing setting examples>

You can set parameters from 1-127. Some parameters do not have numerical value settings.

When sending unprocessed direct sound to the MIX OUTPUT jack:

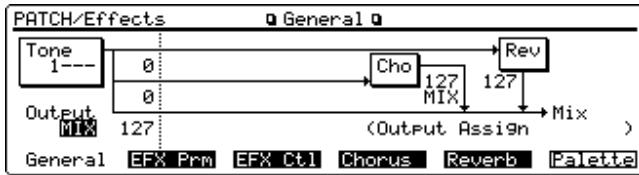

Output Assign: MIX
 Mix/EFX Send Level: 1-127
 Chorus Send Level: 0
 Reverb Send Level: 0

Connecting Reverb and Chorus in series:

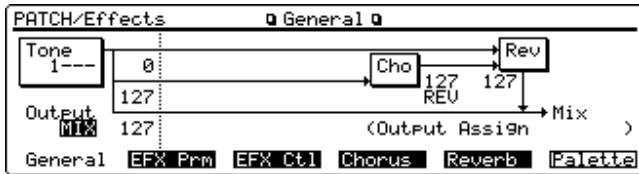

Output Assign: MIX
 Mix/EFX Send Level: 1-127
 Chorus Send Level: 1-127
 Reverb Send Level: 0
 Chorus Level: 1-127
 Chorus Output Assign: REV
 Reverb Level: 1-127

Using EFX only:

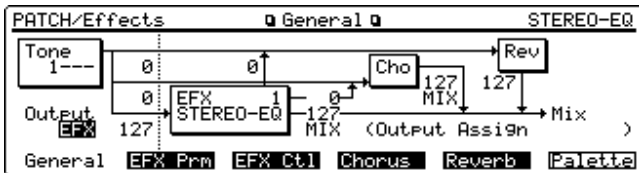

Output Assign: EFX
 Mix/EFX Send Level: 1-127
 Chorus Send Level: 0
 Reverb Send Level: 0
 EFX Output Assign: MIX
 EFX Output Level: 1-127
 EFX Chorus Send Level: 0
 EFX Reverb Send Level: 0

Applying Reverb to only the chorus sound and connecting it and EFX in parallel:

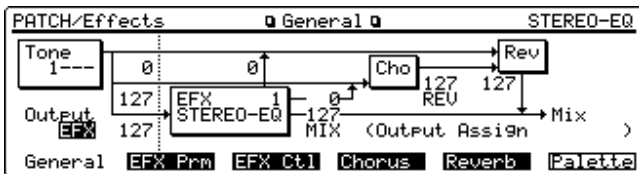

Output Assign: EFX
 Mix/EFX Send Level: 1-127
 Chorus Send Level: 1-127

Reverb Send Level: 0
 EFX Output Assign: MIX
 EFX Output Level: 1-127
 EFX Chorus Send Level: 0
 EFX Reverb Send Level: 0
 Chorus Level: 1-127
 Chorus Output Assign: REV
 Reverb Level: 1-127

Connecting EFX, Chorus and Reverb in series:

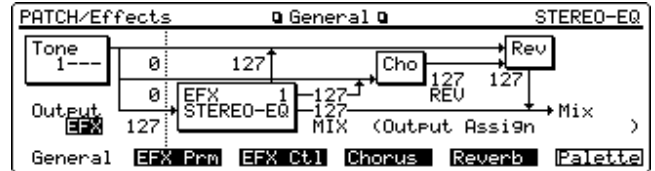

Output Assign: EFX
 Mix/EFX Send Level: 1-127
 Chorus Send Level: 0
 Reverb Send Level: 0
 EFX Output Assign: MIX
 EFX Output Level: 1-127
 EFX Chorus Send Level: 1-127
 EFX Reverb Send Level: 1-127
 Chorus Level: 1-127
 Chorus Output Assign: REV
 Reverb Level: 1-127

Connecting parallel-connected Chorus and Reverb to EFX in series:

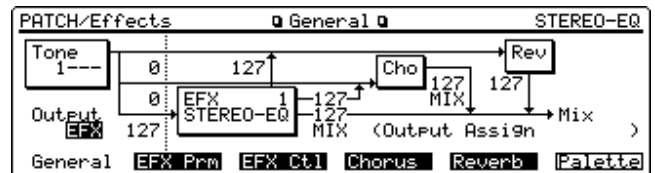

Output Assign: EFX
 Mix/EFX Send Level: 1-127
 Chorus Send Level: 0
 Reverb Send Level: 0
 EFX Output Assign: MIX
 EFX Output Level: 1-127
 EFX Chorus Send Level: 1-127
 EFX Reverb Send Level: 1-127
 Chorus Level: 1-127
 Chorus Output Assign: MIX
 Reverb Level: 1-127

Connecting EFX, Chorus and Reverb in parallel:

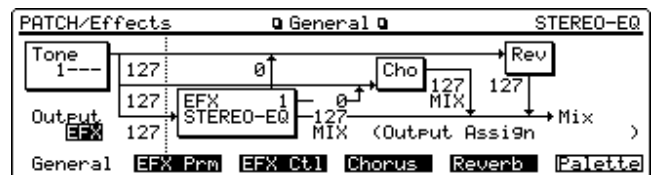

Output Assign: EFX
 Mix/EFX Send Level: 1-127
 Chorus Send Level: 1-127

Reverb Send Level: 1-127
 EFX Output Assign: MIX
 EFX Output Level: 1-127
 EFX Chorus Send Level: 0
 EFX Reverb Send Level: 0
 Chorus Level: 1-127
 Chorus Output Assign: MIX
 Reverb Level: 1-127

Using parallel and series connections simultaneously:

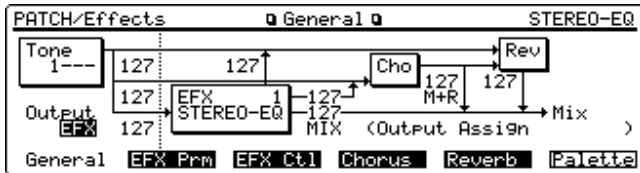

Output Assign: EFX
 Mix/EFX Send Level: 1-127
 Chorus Send Level: 1-127
 Reverb Send Level: 1-127
 EFX Output Assign: MIX
 EFX Output Level: 1-127
 EFX Chorus Send Level: 1-127
 EFX Reverb Send Level: 1-127
 Chorus Level: 1-127
 Chorus Output Assign: M+R
 Reverb Level: 1-127

Sending unprocessed direct sound to the DIRECT OUTPUT jack:

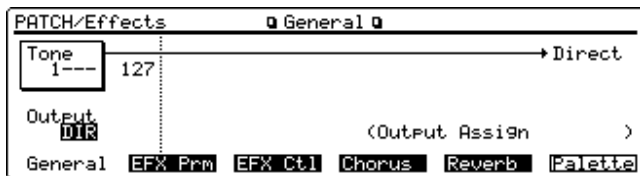

Output Assign: DIR

Sending sound through the EFX to the DIRECT OUTPUT jack:

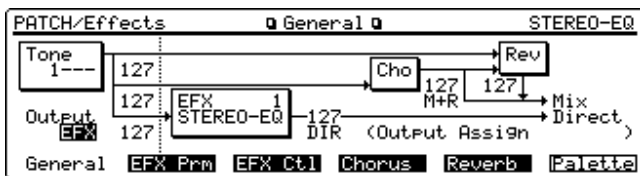

Output Assign: DIR
 Mix/EFX Send Level: 1-127
 EFX Output Assign: DIR
 EFX Output Level: 1-127

EFX Param display

EFX parameters that you can set differ by the type selected using the EFX Type parameter. For details refer to “EFX effect types (EFX Parameter)” (p.74).

EFX Control display

As with Tone parameters, you can also modify EFX parameters using controllers. EFX parameters that can be controlled are indicated in parentheses (). They will differ by the EFX Type parameter (PATCH/Effects/General) settings. For details refer to “EFX effect types (EFX Parameter)” (p.74).

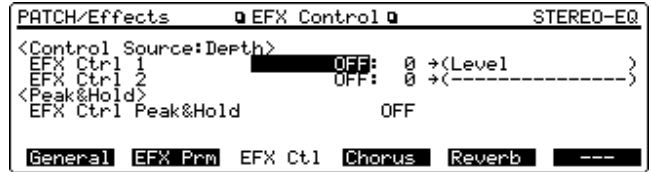

<Control Source>

Each Patch can have two controller assignments (EFX Ctrl 1-2), and you can assign the following controllers to Control Source.

OFF: A controller will not be used.

SYS-CTRL1: System controller 1

SYS-CTRL2: System controller 2

MODULATION: Modulation (MIDI controller number 1)

BREATH: Breath (MIDI controller number 2)

FOOT: Foot (MIDI controller number 4)

VOLUME: Volume (MIDI controller number 7)

PAN: Pan (MIDI controller number 10)

EXPRESSION: Expression (MIDI controller number 11)

PITCH BEND: Pitch bend

AFTERTOUCHE: Aftertouch

* If you want to use a controller that is common to all Patches, or to use a controller that is not available for selection here, first select SYS-CTRL1 or SYS-CTRL2 for Control Source, then use the Sys-Ctrl1 parameter (SYSTEM/Control/Control Assign) or Sys-Ctrl2 parameter (SYSTEM/Control/Control Assign) to select the controller.

<Depth>

Adjusts the degree of EFX parameter changes to occur in response to controller movement. Higher values will result in more change. Negative (-) values will invert the change direction.

<Peak&Hold>

Pedal messages conventionally hold only note messages—not effects settings. This makes it impossible to hold effects settings as you play the phrase.

The XP-80 can hold parameter value changes (maximum change value) even when the controller is returned to its original position after receiving pedal messages.

EFX Ctrl 1 (EFX Controller 1)

Select the controller to control EFX Ctrl 1 parameter with Control Source. Set the amount of EFX parameter change using Depth.

EFX Ctrl 2 (EFX Controller 2)

Select the controller to control EFX Ctrl 2 parameter with Control Source. Set the amount of EFX parameter change using Depth.

EFX Ctrl Peak&Hold (EFX Controller Peak&Hold)

Use Peak&Hold to specify how EFX parameter values will be held after receiving pedal messages.

OFF: EFX parameter values will not be held even if pedal messages are received.

HOLD: EFX parameter values will be held when pedal messages are received.

PEAK: EFX parameter values will be held when pedal messages are received. But if a parameter value greater than the current one is received while Hold is still ON, the new value will be held.

- * When using this function, make sure you also set the Hold-1 parameter (PATCH/LFO&Ctl/Control Switch) ON.
- * If HOLD is selected for Peak&Hold, you must also set the Hold parameter (SYSTEM/Control/Control Source) to the type of pedal message to be controlled.
- * If PEAK is selected for Peak&Hold, you must also set the Peak parameter (SYSTEM/Control/Control Source) to the type of pedal message to be controlled.

Chorus display

On this display you can make the Chorus settings for how chorus will sound and be output.

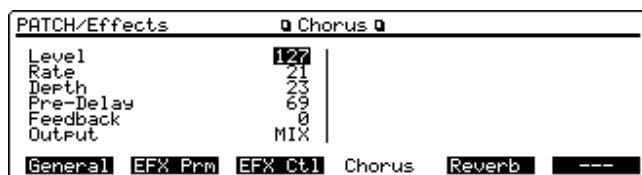

Level (Chorus level)

Adjusts the volume level of the chorus sound.

- * This setting will also affect Chorus Level parameter (PATCH/Effects/General) value.

Rate (Chorus rate)

Adjusts modulation speed for the chorus.

Depth (Chorus depth)

Adjusts modulation depth for the chorus.

Pre-Delay

Adjusts time from when the direct sound begins to when the chorus sound is heard. Higher values create a more spacious sound.

Feedback (Chorus feedback level)

Adjusts the amount of chorus sound that is returned (fed back) to the chorus. Higher values create a more intense effect.

Output (Chorus output assign)

Specifies how chorus sound is to be output.

MIX: The sound will be output from the MIX OUTPUT jacks just as it is.

REVERB: Reverb will be applied.

MIX+REV: The sound will be output from the MIX OUTPUT jacks and to reverb.

- * This setting can also be made on the General display (PATCH/Effects).

Reverb display

This display is used for making reverb effect settings such as reverb type and reverb time.



Type (Reverb/Delay type)

Selects reverb or delay type.

ROOM1: Short, dense reverb

ROOM2: Short, sparse reverb

STAGE1: Reverb with greater late reverberation

STAGE2: Reverb with strong early reflections

HALL1: Reverb with clear reverberation

HALL2: Reverb with rich reverberation

DELAY: Conventional delay

PAN-DLY: Delay with echoes that pan left and right

Level (Reverb/Delay level)

Adjusts the level of the reverb (or delay) sound.

- * This setting also affects Reverb Level parameter (PATCH/Effects/General) values.

Time (Reverb/Delay time)

For any ROOM1–HALL2 Type, this parameter adjusts reverb time. For DELAY or PAN-DLY, this parameter adjusts delay time. Higher values make for a more spacious sound.

HF Damp (Reverb/Delay HF damp)

Adjusts the frequency above which reverb will be cut. The lower this setting, the more the high frequency cut, resulting in a softer, muted reverb. If you want reverb with full frequency extension, set this parameter to BYPASS.

Delay Feedback (Delay feedback level)

If you have selected DELAY or PAN-DLY Type, this parameter adjusts the amount of delayed sound that is returned (fed back) to the delay. Higher values will result in more delay repeats.

Functions of Performance parameters

Settings common to the entire Performance (Common)

Common display

This display is used when setting parameters that are not part of other groups. These include Performance Name and Key Mode.



Performance Name

You can use up to 12 alphanumeric characters to name the Performance.

Key Mode

Sets for how the sound source will play from the XP-80 keyboard. Key Mode setting appears on the Play display (PERFORM).

LAYER: With a Layer Performance, all Parts with Local Sw parameter (PERFORM/MIDI/Part MIDI) set ON will sound as the keyboard is played. MIDI messages will be transmitted from the keyboard to the sequencer as determined by the Local Sw parameter (PERFORM/MIDI/Part MIDI) setting for each Part.

Transmission of MIDI messages from the keyboard to external MIDI devices is determined by the Tx Switch parameter (PERFORM/MIDI/Part MIDI) setting for each Part.

SINGLE: With a Single Performance, only the current Part will sound when the keyboard is played. MIDI messages can be transmitted from the keyboard to the sequencer/external MIDI devices even if the current Part's Local Sw parameter (PERFORM/MIDI/Part MIDI) is set OFF.

- * It is also possible to switch between SINGLE and LAYER by pressing [LOCAL/TX/RX] to open the LOCAL/TX/RX window, and pressing [F5] (K.Mode).
- * If LAYER has been selected and you try to play Patches of all Parts, you probably won't be able to play many simultaneous voices. When layering Patches, be aware of the number of voices available and turn off unnecessary Parts. Making Key Range settings for each Part allows you to split the keyboard to play different Parts in separate sections.

[PERFORM]→[F2] (K.Range)/[F3] (Part)

Clock Source (Performance Clock Source)

With some parameters you can set a time value in terms of a note length which can be determined by a tempo you specify (reference tempo). These include Rate parameter (PATCH/LFO&Ctl/LFO1,2 Param), Time parameter (PATCH/WG/Wave Param), and some EFX parameters. A reference tempo can be set for each Patch, but if a Patch is used in Performance mode, the Patch settings will be ignored. Select your sync source.

PERFORM: Synchronizes to the Performance Tempo setting.

SEQUENCER: Synchronizes to the sequencer's tempo clock.

- * The Performance Clock does not transmit clock messages from MIDI OUT.

Performance Tempo

Sets the Performance tempo.

Setting the keyboard range (K.Range)

Part Key Range Lower:Upper display

On this display, you can specify the range of notes that will play each Part. Use this option to make notes in different keyboard areas play different Parts. The specified range will be displayed graphically.

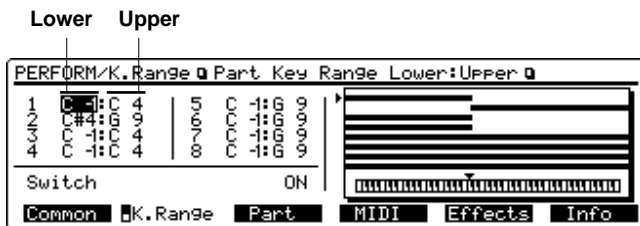

- * Part Key Range Lower: Upper consists of two display pages: a Part 1–8 page and a Part 9–16 page. To change display page, press [F2] (K.Range).

1 (Part 1 key range lower:upper)– 16 (Part 16 key range lower:upper)

Lower specifies the lowest note that each Part can play and Higher specifies the highest, from C-1 to G9.

- * If K.Range (PATCH/Common/Tone Key Range) settings have been assigned to the Patch, only the overlapping notes made in the Key Range settings (of Patch and Performance) will play.

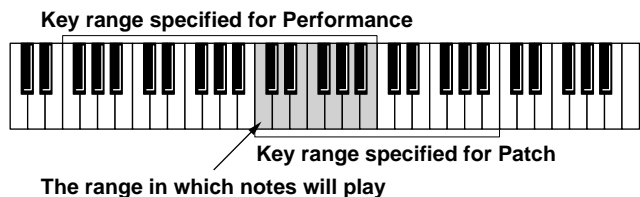

- * Lower cannot be set to a value greater than Upper, or Upper to a value smaller than Lower. If you do this by mistake, the two values will change together.

- * If you've used [+OCT] or [-OCT] or the Transpose parameter (SYSTEM/Setup/Setup) to transpose XP-80 keyboard pitch, the keyboard area specified by Key Range will also shift.

Switch (Key range switch)

Specifies if key range setting is to be used or not. The key range setting is used when the Switch parameter is ON.

- * It is also possible to switch between ON and OFF by pressing [LOCAL/TX/RX] to open the LOCAL/TX/RX window, and pressing [F6] (K.Range).

Making settings for each Part (Part)

Part Param (Part parameter) display

This display is for assigning a Patch for each Part and setting volume and other adjustments for the Part.



Patch Group

Selects the Patch group for each Part (or Rhythm Set for Part 10).

USER: Patches from user memory

PR-A–PR-C: Patches from preset memory A–C

GM: GM Patches

XP-A–XP-D: Patches from Wave Expansion Boards installed in EXP-A–D slots

- * To display the Patch list (Rhythm Set for Part 10), press [SOUND LIST].
- * Selecting a Patch group from a Wave Expansion Board that is not installed is of course not possible.

Patch Number

Selects the Patch number assigned to each Part (or Rhythm Set number for Part 10).

- * To display the Patch list (Rhythm Set for Part 10), press [SOUND LIST].

Part Level

Adjusts the volume of each Part. Use this parameter mainly for adjusting the volume balance between Parts.

Part Pan

Adjusts pan for each Part. L64 pans hard left, 0 is center and 63R pans hard right.

- * As Pan settings are also contained in a Patch, each Patch will move by what is specified here from its current position in the stereo soundfield.

Coarse Tune (Part coarse tune)

Adjusts pitch of each Part in semitone steps (-4- +4 octaves). The pitch will change relative to the pitch specified for the Patch as being 0.

Fine Tune (Part fine tune)

Adjusts the pitch specified for the Coarse Tune parameter in 1-cent (1/100th of a semitone) steps (-50- +50 cents).

Octave Shift

Adjusts pitch for each Part in 1-octave steps (-4- +4 octaves). The pitch will shift relative to the pitch specified for the Patch as being 0.

Voice Reserve

This setting determines how many voices will be reserved for each Part when more than 64 simultaneous voices are requested.

- * You can set any Voice Reserve value until the total of all Parts reaches 64 voices. The number of remaining voices available is indicated at the right of the parameter name (rest). Refer to this when you make settings.

Making MIDI settings for a Part (MIDI)

Part MIDI display

Use this display to determine how each Part will transmit and receive MIDI messages.

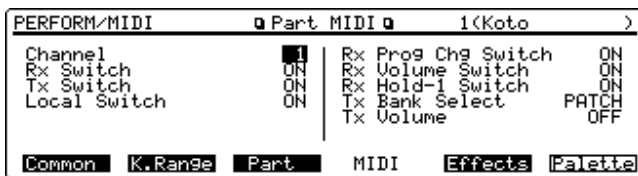

Channel (MIDI channel)

Specifies each Part's MIDI channel.

- * If you set this to the same channel as specified by the Perform Ctrl-Ch parameter (SYSTEM/MIDI/MIDI Param 1), Control Channel selection will take priority. Trying to use Program Change messages to select Patches will select Performances instead. In order to select Patches, change the Perform Ctrl-Ch parameter (SYSTEM/MIDI/MIDI Param 1) to a different setting.

Rx Switch (Receive switch)

Specifies whether each Part is to receive MIDI messages (ON) or not (OFF). Set OFF, and the Part will respond to the keyboard, but not to the internal sequencer or external MIDI devices. This is normally left ON, but you set it OFF when you don't want a specific Part to be playing during a song playback.

- * This setting can also be switched using Rx Switch parameter in the Local/Tx/Rx window.

Tx Switch (Transmit switch)

Specifies whether you want each Part to transmit MIDI messages from the controller section (ON) or not (OFF). At OFF, the Part responds to the keyboard, but keyboard Performance data (MIDI messages) will not be sent from

MIDI OUT. This is normally left ON, but you can set it OFF when you don't want the XP-80 to control external sound sources.

- * This setting can also be switched using the Tx Switch parameter in the Local/Tx/Rx window.

Local Switch

Specifies whether you want to disconnect the controller section from the internal sound source (ON) or not (OFF) for each Part. At OFF, the keyboard will not play that Part, but keyboard performance data (MIDI messages) will be sent from MIDI OUT. This is normally left ON, but you can set it OFF when you want the XP-80 keyboard and controllers to only control external sound sources.

- * This setting can also be switched using the Local Sw parameter in the Local/Tx/Rx window.

Rx Prog Chg Switch (Receive program change switch)

Specifies whether you want each Part to receive MIDI Program Change messages (ON) or not (OFF).

Rx Volume Switch (Receive volume switch)

Specifies whether you want each Part to receive MIDI Volume messages (ON) or not (OFF).

Rx Hold-1 Switch (Receive hold 1 switch)

Specifies whether you want each Part to receive MIDI Hold 1 messages (ON) or not (OFF).

Tx Bank Select (Transmit bank select group)

When you select a Performance, the XP-80 will normally transmit the Performance's Bank Select and Program numbers to external MIDI devices. If you set the Tx Bank Select parameter to GROUP1-7, the Program number of the Patch or Rhythm Set assigned to each Part as well as the Bank Select number you've set on the Bank Select Group display (SYSTEM/MIDI) will also be transmitted simultaneously. This allows changing sounds on multiple external devices (p.179).

PATCH: When you select a Performance, only the Bank Select and Program numbers of that Performance will be transmitted to external MIDI devices. This setting should normally be used.

GROUP1: When you select a Performance, the Program number of the Patch or Rhythm Set assigned to each Part and the values set for <Grp 1>'s Bank LSB parameter and Bank MSB parameter (SYSTEM/MIDI/Bank Select Group) will be transmitted to external MIDI devices together with the Performance's Bank Select and Program numbers.

GROUP2: This setting works the same way as GROUP1, but the Bank LSB parameter and Bank MSB parameter (SYSTEM/MIDI/Bank Select Group) values for <Grp 2> will be transmitted to external devices, instead of <Grp 1>.

GROUP3: This setting works the same way as GROUP1, but the Bank LSB parameter and Bank MSB parameter (SYSTEM/MIDI/Bank Select Group) values for <Grp 3> will be transmitted to external devices, instead of <Grp 1>.

GROUP4: This setting works the same way as GROUP1, but the Bank LSB parameter and Bank MSB parameter (SYSTEM/MIDI/Bank Select Group) values for <Grp 4> will be transmitted to external devices, instead of <Grp 1>.

GROUP5: This setting works the same way as GROUP1, but the Bank LSB parameter and Bank MSB parameter (SYSTEM/MIDI/Bank Select Group) values for <Grp 5> will be transmitted to external devices, instead of <Grp 1>.

GROUP6: This setting works the same way as GROUP1, but the Bank LSB parameter and Bank MSB parameter (SYSTEM/MIDI/Bank Select Group) values for <Grp 6> will be transmitted to external devices, instead of <Grp 1>.

GROUP7: This setting works the same way as GROUP1, but the Bank LSB parameter and Bank MSB parameter (SYSTEM/MIDI/Bank Select Group) values for <Grp 7> will be transmitted to external devices, instead of <Grp 1>.

- * If a Single Performance is selected, this setting is ignored.
- * With a GROUP1-7 setting, the Program number of the Patch or Rhythm Set assigned to each Part and the Bank Select number you've set on the Bank Select Group display (SYSTEM/MIDI) will not be recorded on the XP-80's internal sequencer. When the Tx Switch parameter is set OFF, the Program number of the Patch or Rhythm Set assigned to each Part and the Bank Select number set on the Bank Select Group display (SYSTEM/MIDI) will not be transmitted to external MIDI devices.
- * With a GROUP1-7 setting, the Program number of the Patch or Rhythm Set assigned to each Part and the Bank Select number you've set on the Bank Select Group display (SYSTEM/MIDI) will be transmitted on the Part's MIDI channel.

Tx Volume (Transmit volume)

If you want Volume messages for each Part to be transmitted to external MIDI devices when you select a Performance, set the desired volume here. If not, set this OFF.

Setting effects for a Performance (Effects)

Effects parameter configurations are almost identical for Performance and Patch. For details regarding effects refer to "Setting effects for a Patch" (p.60). Here only effects parameters different from those of the Patch are discussed.

- * When setting effects for a Performance, follow the procedure discussed in "Routing effects" (p.60), but substitute Part for Tone.

General (Effects general) display

This is where you decide how the effects you want to use will be connected. Parameters on the display will reflect the Output Assign parameter setting.

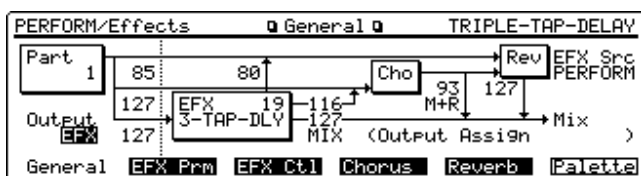

Output Assign

MIX: The direct sound is output to MIX OUTPUT jack. If Chorus and/or Reverb is selected, these effects are output together with the direct sound.

EFX: The direct sound is sent to EFX. After passing through EFX, the sound travels to the destination specified by the EFX OUTPUT Assign parameter.

DIR: Only direct sound is output to the DIRECT OUT jack. If Chorus and/or Reverb is selected, these settings have no effect.

PAT: The direct sound is output as specified by the Output Assign parameter of the Patch assigned to each Part. The Part's Output Assign, Mix/EFX Send Level, Chorus Send Level and Reverb Send Level parameter settings will be multiplied by those settings for the Patch.

Reverb Send Level

Adjusts reverb intensity for each Part.

- * If DIR is selected for the Output Assign parameter, this setting has no effect because reverb is not applied.

Chorus Send Level

Adjusts chorus amount for each Part.

- * If DIR is selected for the Output Assign parameter, this setting has no effect because chorus is not applied.

Mix/EFX Send Level

Adjusts volume of each Part.

If EFX is selected for the Output Assign parameter, higher values will increase EFX sound volume. With MIX or DIRECT, higher values increase direct sound volume.

EFX Src (EFX source)

Selects the EFX parameter settings to be used by the Performance. If you want to apply the Performance's EFX parameter settings to the entire Performance, select PERFORM. To use the EFX parameter settings of the Patch that's assigned to one of the Parts, select the Part number.

- * Part 10 (Rhythm Set) can't be selected because it does not contain effects settings. If you've selected any of PARTs 1-9 and 11-16, the EFX settings of the Patch assigned to that Part will be displayed and you'll be able to modify them. To keep the modified EFX settings, rewrite the Patch settings.

<Using the set Tone volume balance (the varying levels of the four Tones) of a Patch in a Part>

Set the Output Assign parameter to PAT.

This lets you adjust the Part's Mix/EFX Send Level, Chorus Send Level and Reverb Send Level parameter settings while keeping the relative value differences among Tones.

<Using Patch EFX parameter settings for the Performance>

Set the Output Assign parameter to PAT and the EFX Src parameter to the Part number to which the desired Patch is assigned (PART1-9, 11-16).

The EFX parameter settings of the Patch assigned to the selected Part will apply to the entire Performance.

Confirming MIDI information for each Part (Info)

- * With the Arpeggiator on, closing the Arpeggio window in the Play display (PERFORM) will assign the function to re-open the Arpeggio window to [F6]. To call up the Part Information display, hold down [SHIFT] as you press [F6].

Part Information display

On this display you can confirm the receive status of various MIDI messages for all 16 Parts at once, convenient when you want to see if the sound source is responding correctly to messages from the keyboard, sequencer or external MIDI controllers.

- * To reset the values shown on the Part Information display to the standard values, hold down [SHIFT] as you press [EXIT].

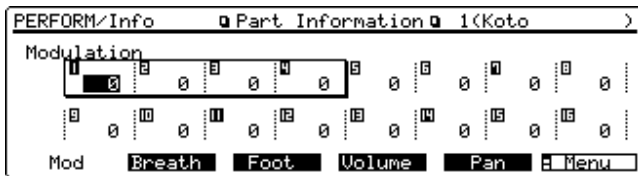

The Part Information display consists of three menus. After selecting a menu through [F6] (Menu), press [F1]–[F5] to call up the display page for each MIDI message.

- Modulation : [F1] (Mod)
- Breath : [F2] (Breath)
- Foot : [F3] (Foot)
- Volume : [F4] (Volume)
- Pan : [F5] (Pan)
- Expression : [F1] (Exp)
- Hold-1 : [F2] (Hold)
- Pitch Bend : [F3] (Bend)
- Channel Aftertouch : [F4] (Aft)
- Voices : [F5] (Voices)
- The number of voices
- System Control 1: [F1] (Sys 1)

MIDI message specified by the Sys-Ctrl 1 parameter (SYSTEM/Control/Control Assign)

System Control 2: [F2] (Sys2)

MIDI message specified by the Sys-Ctrl 2 parameter (SYSTEM/Control/Control Assign).

<MIDI message transmission>

When you modify a value shown on the Part Information display (excluding Voice), the MIDI message of the modified value will be transmitted to the current Part, and to the XP-80's sequencer or external MIDI devices on that Part's MIDI channel simultaneously.

If Layer Performance has been selected, this MIDI message will not be transmitted to external MIDI devices if the Tx Switch parameter (PERFORM/MIDI/Part MIDI) of the current Part is set OFF.

<Transmitting MIDI messages using the Sound Palette>

With the Sound Palette's four sliders, you can transmit each Modulation through System Control 2 MIDI message to the current Part, internal sequencer and external MIDI devices. This lets you use the Sound Palette as a mixer.

<Procedure>

- 1 Call up the Part Information display of the MIDI message to be transmitted.
- 2 Press [◀] or [▶] to move the cursor to the Part whose value you want to modify.

You can adjust the values of the boxed four Parts using the sliders.

If you've selected any of Parts 1–4, sliders 1, 2, 3, and 4 adjust Parts 1, 2, 3, and 4, respectively.

If you've selected any of Parts 5–8, sliders 1, 2, 3, and 4 adjust Parts 5, 6, 7, and 8, respectively.

If you've selected any of Parts 9–12, sliders 1, 2, 3, and 4 adjust Parts 9, 10, 11, and 12, respectively.

If you've selected any of Parts 13–16, sliders 1, 2, 3, and 4 adjust Parts 13, 14, 15, and 16, respectively.

- 3 Move each slider to adjust the respective value.

Functions of Rhythm Set parameters

Naming a Rhythm Set (Common)

Rhythm Set Name display



Rhythm Set Name

You can use up to 12 alphanumeric characters to name the Rhythm Set.

Modifying waveform and pitch of a Rhythm Tone (Key WG)

- * The Key WG group consists of Wave and Pitch Envelope display pages. To flip between these two, press [F2] (Key WG).

Wave display

Select the basic Rhythm Tone waveform and modify it or adjust pitch.

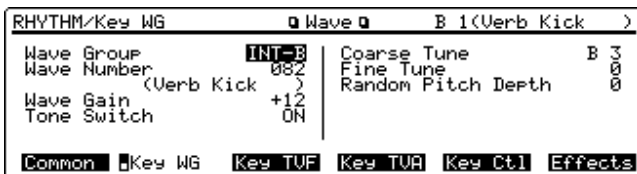

Wave Group

Selects the waveform group.

INT A-B: Waveform stored in the unit's internal memory.

EXP A-D: Waveform stored in a Wave Expansion Board installed in EXP-A-D slots.

- * To display the waveform list, press [SOUND LIST].
- * Selecting a Patch group from a Wave Expansion Board that is not installed is of course not possible.

Wave Number

Selects the basic waveform for a Rhythm Tone. The name of the wave will be displayed in parentheses ().

- * To display the waveform list, press [SOUND LIST].

Wave Gain

Adjusts the gain over a -6- +12 dB range, in steps of 6 dB. An increase of 6 dB doubles the gain.

Tone Switch

Turn it on when you want a specific Rhythm Tone. Keep it OFF otherwise.

Coarse Tune

Sets the key pitch for the Rhythm Tone played.

Fine Tune

Adjusts pitch in 1-cent (1/100th of a semitone) steps (-50-+50 cents).

Random Pitch Depth

For random pitch changes with every key press, use this parameter to set the desired amount (in cents) of pitch change. If you don't want random pitch changes set it to 0.

Pitch Envelope display

This is where to set the pitch envelope (how pitch changes over time). The pitch envelope is displayed graphically.

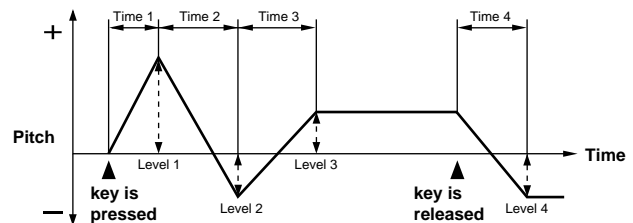
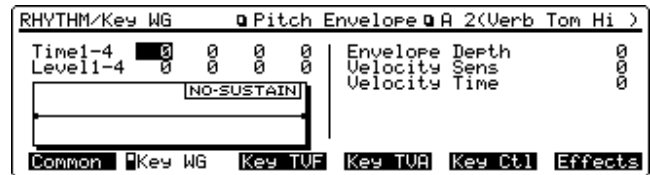

Time1-4 (Pitch envelope time 1-4)

Sets pitch envelope's time (Time 1-4). Higher settings extend the duration over which pitch changes from one point to another (for example, time for the pitch to change from Level 1 to Level 2 for Time 2).

Level1-4 (Pitch envelope level 1-4)

Sets pitch envelope level (Level 1-4) to determine pitch of each point relative to the reference pitch (pitch set for Coarse Tune or Fine Tune). Positive (+) values will raise pitch over the reference pitch, and negative (-) values lower pitch below the reference pitch.

Envelope Depth (Pitch envelope depth)

Adjusts pitch envelope amount. Higher settings produce more change. Negative (-) values invert the envelope.

Velocity Sens (Pitch envelope velocity sensitivity)

This parameter should be used when you want keyboard playing dynamics (velocity) to impact on pitch envelope amount. With positive (+) values, the amount of pitch envelope increases as the key is pressed with increasing force. Negative (-) values reduce pitch envelope amount as the key is pressed with increasing force.

Velocity Time (Pitch envelope velocity time sensitivity)

Use this parameter when you want keyboard playing dynamics (velocity) to impact on the pitch envelope time. With positive (+) settings, a higher keyboard velocity will reduce (speed up) Time value. With negative (-) settings, higher keyboard velocity will increase (slow down) Time value.

Changing the tone (filter) of a Rhythm tone (Key TVF)

* The Key TVF group consists of the TVF Param and TVF Envelope display pages. To switch between these two, press [F3] (Key TVF).

TVF Param (TVF parameter) display

This display is for TVF (Time Variant Filter) settings. By changing a sound's brightness or thickness, a Rhythm Tone can be modified. Frequency characteristics of the filter are displayed graphically.

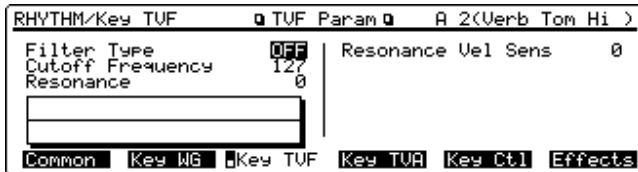

Filter Type

Selects the filter type. A filter attenuates a specific frequency range to modify the brightness or thickness of sound.

OFF: No filter is used.

LPF: Low Pass Filter cuts frequencies above the cutoff frequency to round off the sound. This is the most common filter used in synthesizers.

BPF: Band Pass Filter cuts frequencies below and above the cutoff frequency range. Most effective for creating sounds with strong characteristics.

HPF: High Pass Filter cuts the frequencies below the cutoff frequency. Suitable for creating percussive sounds emphasizing highs.

PKG: Peaking Filter emphasizes frequencies around the cutoff frequency. This expresses the special sound of a drum.

Cutoff Frequency

Sets the frequency at which the filter starts to have an effect (cutoff frequency) on the waveform's frequency components.

With LPF selected for the Filter Type parameter, lower Cutoff Frequency settings will reduce upper harmonics for a more rounded sound. Higher settings will make sound brighter.

If BPF is selected, harmonic components will change depending on the Cutoff Frequency setting. Using this setting effectively will create some highly distinctive sounds.

With HPF selected, higher Cutoff Frequency settings will reduce lower harmonics to emphasize just the brighter components of the sound.

With PKG selected, the harmonics to be emphasized will vary depending on Cutoff Frequency setting.

Resonance

Emphasizes frequencies around the cutoff frequency. Excessive level at some settings can cause oscillation and distortion.

Resonance Vel Sens (Resonance velocity sensitivity)

Use this parameter if you want velocity to influence the Resonance parameter. If you want higher keyboard velocities to create more changes in Resonance, use positive (+) values. For less Resonance change, use negative (-) values.

TVF Envelope display

This display is used for setting TVF envelope (how cutoff frequency changes over time). The TVF envelope is displayed graphically.

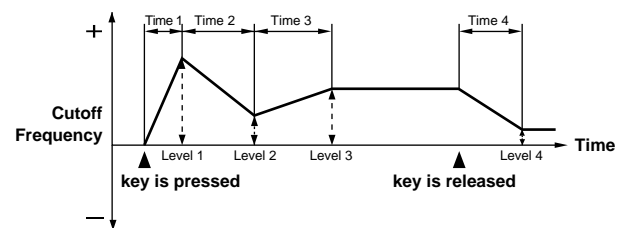
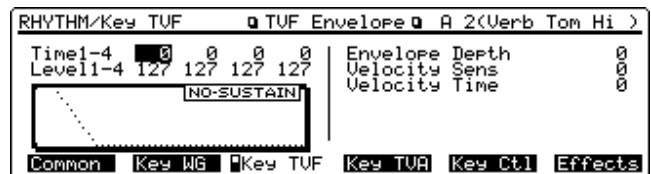

Time1-4 (TVF envelope time 1-4)

Sets TVF envelope time (Time1-4). Higher settings will extend the time over which cutoff frequency changes from one point to the next point (for example, time during which the cutoff frequency changes from Level 1 to Level 2 for Time 2).

Level1-4 (TVF envelope level 1-4)

Sets the TVF envelope level (Level1-4) to determine cutoff frequency of each point relative to the specified Cutoff Frequency parameter value.

Envelope Depth (TVF envelope depth)

Adjusts TVF envelope amount. Higher settings result in more change. Negative (-) settings invert the envelope.

Velocity Sens (TVF envelope velocity sensitivity)

The parameter to use when you want keyboard playing dynamics (velocity) to affect TVF envelope amount. Positive (+) settings increase TVF envelope amount as a key is pressed harder. Negative (-) settings decrease TVF envelope amount when the key is pressed harder.

Velocity Time (TVF envelope velocity time sensitivity)

The parameter to use when you want keyboard playing dynamics (velocity) to affect the TVF envelope time. At positive (+) settings, higher keyboard velocities will reduce (speed up) Time value. At negative (-) settings, higher keyboard velocities will increase (slow down) Time value.

Changing the volume of a Rhythm Tone (Key TVA)

* The Key TVA group consists of two display pages -TVA Param display and TVA Envelope display. To change the display page, press [F4] (Key TVA).

TVA Param (TVA Parameter) display

TVA (Time Variant Amplifier) controls volume changes and panning for each Rhythm Tone.

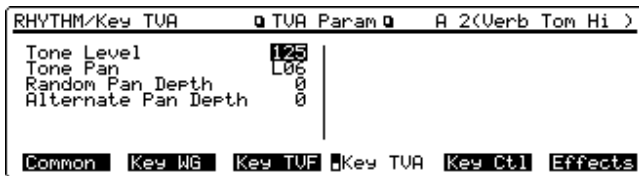

Tone Level (Rhythm Tone level)

Adjusts the basic volume of a Rhythm Tone. Use this parameter to adjust the volume balance between Rhythm Tones as desired.

Tone Pan (Rhythm Tone pan)

Adjusts the pan (location in stereo soundfield) for each Rhythm Tone. L64 pans hard left, 0 is center and 63R pans hard right.

Random Pan Depth

Use this parameter to select key-initiated random panning. Set a desired value for the panning change. Set this to 0 if you don't want random panning.

Alternate Pan Depth

Use this parameter for key-initiated left/right alternate panning. Higher values result in greater panning. L or R values can be set, and these can be used to reverse the left/right panning order if desired. If you want to alternate the pan position of two Rhythm Tones, set them to opposite L and R settings.

TVA Envelope display

This display is used when setting TVA envelope (how TVA level changes over time). The specified TVA envelope is displayed graphically.

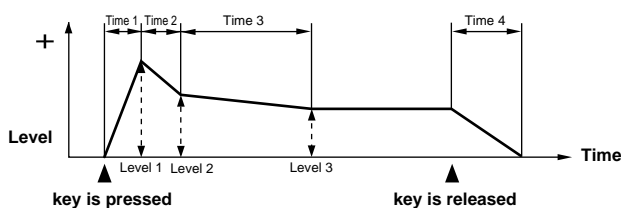
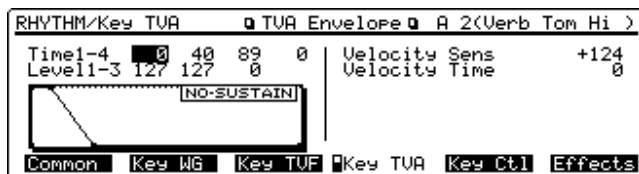

Time1-4 (TVA envelope time 1-4)

Sets TVA envelope time (Time 1-4). Higher settings will extend the time over which the volume changes from one point to the next (for example, duration for volume to change from Level 1 to Level 2 for Time 2).

Level1-3 (TVA envelope level 1-3)

Sets TVA envelope level (Level 1-3) to adjust the volume level of each point relative to the reference volume (specified Tone Level value).

Velocity Sens (TVA envelope velocity sensitivity)

Use this parameter when you want velocity to influence TVA envelope amount. Positive (+) settings increase the amount of TVA envelope as the key is pressed with increasing force. Negative (-) settings do the reverse.

Velocity Time (TVA envelope velocity time sensitivity)

Use this parameter when you want velocity to influence the Time parameter of the TVA envelope. With positive (+) settings, greater keyboard velocities will reduce (speed up) Time value.

With negative (-) settings, greater keyboard velocities will increase (slow down) Time value.

Controlling how a Rhythm Tone will sound with controllers (Key Ctl)

Control Param (Control parameter) display

On this display you can assign functions to the XP-80's controllers and determine how each key will sound.

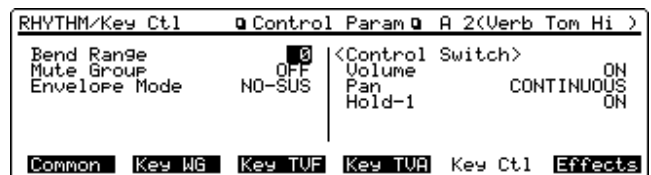

Bend Range (Pitch bend range)

Sets the amount of pitch change (in semitones) that will occur when the Bender lever is moved (-1+ +1 octave).

Mute Group

The Mute Group function lets you keep certain Rhythm Tones with the same settings from sounding at the same time. Take an acoustic drum set as an example. An open hi-hat and a closed hi-hat can't sound simultaneously. To simulate this situation on the XP-80, set each hi-hat sound to the same Mute Group number.

Up to 31 Mute Groups can be used. When not muting notes, set it OFF.

Envelope Mode

Usually when a looped Wave (p.42) is selected, sound will continue as long as a key remains pressed. Select NO-SUS if you want sound to decay naturally even if the key is not released.

* If you select a one-shot Wave, it will not sustain even if this parameter is set to SUSTAIN.

Volume (Volume control switch)

If you want Volume messages to be received, set this parameter ON. If not, set it OFF.

Pan (Pan control switch)

Specifies how pan messages are received.

OFF: Not received.

CONTINUOUS: Whenever pan messages are received, the stereo position of the specified note will change.

KEY-ON: The stereo position of a specific note changes when the note is played. The stereo position of the specified note will not change until the next key press even if pan messages are received while it is being played. In this case, only the stereo position of the next played note will change, not the current sounding note.

Hold-1 (Hold1 control switch)

Set this ON when you want Hold1 messages to be received. If not, set it OFF.

* If NO-SUS is selected for the Envelope Mode parameter, the Hold-1 parameter values will have no effect.

Setting effects for a Rhythm Tone (Effects)

When in Rhythm Set Mode, only Part 10 of a Performance is selected, so effects settings of the currently selected Performance will be used. The following parameters, however, can be specified for each note (Rhythm Tone).

- * For details regarding effects refer to "Setting effects for a Patch" (p.60) or "Setting effects for a Performance" (p.68).
- * With the Arpeggiator on, closing the Arpeggio window in the Play display (RHYTHM) will assign the function to re-open the Arpeggio window to [F6]. To set effects parameters, hold down [SHIFT] as you press [F6] to call up the relevant display.

General (Effects general) display

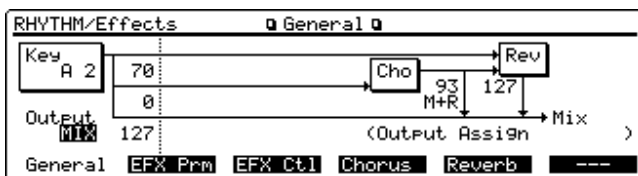

Output Assign

Specifies how each Rhythm Tone will be output.

MIX: The direct sound is output to the MIX OUTPUT jack. If Chorus and/or Reverb is selected, these effects are output together with the direct sound.

EFX: The direct sound is output to the EFX. After passing through the EFX, the sound is output as specified by the EFX OUTPUT Assign parameter.

DIR: Only direct sound is output to DIRECT OUT. If Chorus and/or Reverb is selected, the settings of these effects will have no effect.

Mix/EFX Send Level

Sets the volume level of each Rhythm Tone.

With EFX selected for the Output Assign parameter, higher values will increase the EFX sound volume. If MIX or DIRECT is selected, higher values will increase direct sound volume.

Chorus Send Level

Adjusts the amount of chorus for each Rhythm Tone.

* If DIR is selected for the Output parameter, this cannot be set as no chorus is applied.

Reverb Send Level

Adjusts the intensity of reverb for each Rhythm Tone.

* If DIR is selected for the Output parameter, this cannot be set as no reverb is applied.

EFX effect types (EFX Parameter)

EFX provides 40 types of effect. Some of these consist of two different effects connected in series or parallel.

Select the EFX type you want using the EFX Type parameter on the General display and set each EFX parameter on the EFX Param display.

PATCH/Effects		EFX Param	EFX Type name
Low Freq	200	P1 Gain	0
Low Gain	0	P2 Freq	1000
High Freq	4000	P2 Q	1.0
High Gain	0	P2 Gain	0
P1 Freq	1000	Level	127
P1 Q	1.0		

General EFX Prm EFX Ctrl Chorus Reverb ---

* Parameters marked with a sharp (#) can be controlled using a specified controller. Settings in the Patch or Performance EFX Control display (PATCH/Effects), EFX Control display (PERFORM/Effects) will determine how these parameters are controlled.

The EFX control sources can be set for each Patch or Performance.

1: STEREO-EQ (Stereo equalizer)

This is a four-band stereo equalizer (low, mid x 2, high).

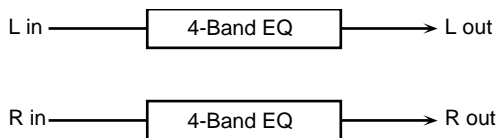

Low Freq (Low frequency)

Select the frequency of the low range (200 Hz/400 Hz).

Low Gain

Adjust the gain of the low frequency.

High Freq (High frequency)

Select the frequency of the high range (4000 Hz/8000 Hz).

High Gain

Adjust the gain of the high frequency.

P1 Freq (Peaking 1 frequency)

Adjust the frequency of Peaking 1 (mid range).

P1 Q (Peaking 1 Q)

This parameter adjusts the width of the area around the P1 Freq parameter that will be affected by the Gain setting. Higher values of Q will result in a narrower area being affected.

P1 Gain (Peaking 1 gain)

Adjust the gain for the area specified by the P1 Freq parameter and P1 Q parameter settings.

P2 Freq (Peaking 2 frequency)

Adjust the frequency of Peaking 2 (mid range).

P2 Q (Peaking 2 Q)

This parameter adjusts the width of the area around the P2 Freq parameter that will be affected by the Gain setting. Higher values of Q will result in a narrower area being affected.

P2 Gain (Peaking 2 gain)

Adjust the gain for the area specified by the P2 Freq parameter and P2 Q parameter settings.

Level (Output level)

Adjust the output level.

2: OVERDRIVE

This effect creates a soft distortion similar to that produced by vacuum tube amplifiers.

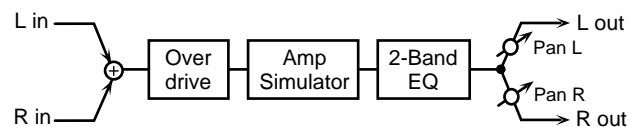

Drive

Adjust the degree of distortion. The volume will change together with the degree of distortion.

Amp Type (Amp simulator type)

Select the type of guitar amp.

SMALL : small amp

BUILT-IN : single-unit type amp

2-STACK : large double stack amp

3-STACK : large triple stack amp

Low Gain

Adjust the gain of the low frequency range.

High Gain

Adjust the gain of the high frequency range.

Pan (Output pan)

Adjust the stereo location of the output sound. L64 is far left, 0 is center, and 63R is far right.

Level (Output level)

Adjust the output level.

3: DISTORTION

This effect produces a more intense distortion than Overdrive.

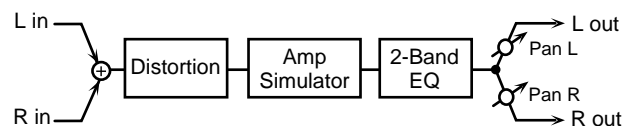

Drive

Adjust the degree of distortion. The volume will change together with the degree of distortion.

Amp Type (Amp simulator type)

Select the type of guitar amp.

SMALL : small amp

BUILT-IN : single-unit type amp

2-STACK : large double stack amp

3-STACK : large triple stack amp

Low Gain

Adjust the gain of the low frequency range.

High Gain

Adjust the gain of the high frequency range.

Pan (Output pan)

Adjust the stereo location of the output sound. L64 is far left, 0 is center, and 63R is far right.

Level (Output level)

Adjust the output level.

4: PHASER

A phaser adds a phase-shifted sound to the original sound, producing a twisting modulation that creates spaciousness and depth.

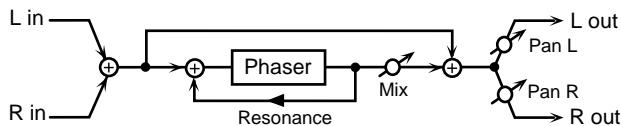

Manual

Adjust the basic frequency from which the sound will be modulated.

Rate

Adjust the frequency (period) of modulation.

Depth

Adjust the depth of modulation.

Resonance

Adjust the amount of Phaser feedback. Larger values produce a more distinctive sound.

Mix (Mix level)

Adjust the ratio with which the phase-shifted sound is combined with the direct sound.

Pan (Output pan)

Adjust the stereo location of the output sound. L64 is far left, 0 is center, and 63R is far right.

Level (Output level)

Adjust the output level.

5: SPECTRUM

Spectrum is a type of filter which modifies the timbre by boosting or cutting the level at specific frequencies. It is similar to an equalizer, but has 8 frequency points fixed at locations most suitable for adding character to the sound.

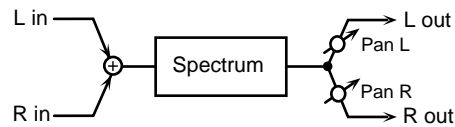

Band 1 (Band 1 gain)

Adjust the 250 Hz level.

Band 2 (Band 2 gain)

Adjust the 500 Hz level.

Band 3 (Band 3 gain)

Adjust the 1 kHz level.

Band 4 (Band 4 gain)

Adjust the 1250 Hz level.

Band 5 (Band 5 gain)

Adjust the 2000 Hz level.

Band 6 (Band 6 gain)

Adjust the 3150 Hz level.

Band 7 (Band 7 gain)

Adjust the 4000 Hz level.

Band 8 (Band 8 gain)

Adjust the 8000 Hz level.

Width (Band width)

Simultaneously adjust the width of the adjusted areas for all the frequency bands.

Pan (Output pan)

Adjust the stereo location of the output sound. L64 is far left, 0 is center, and 63R is far right.

Level (Output level)

Adjust the output level.

6: ENHANCER

The Enhancer controls the overtone structure of the high frequencies, adding sparkle and tightness to the sound.

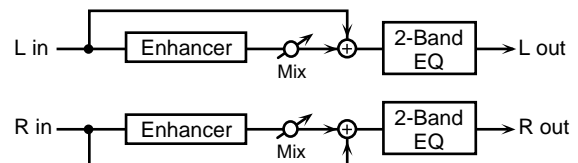

Sens (Sensitivity)

Adjust the sensitivity of the enhancer.

Mix (Mix level) #

Adjust the ratio with which the overtones generated by the enhancer are combined with the direct sound.

Low Gain

Adjust the gain of the low frequency range.

High Gain

Adjust the gain of the high frequency range.

Level (Output level)

Adjust the output level.

7: AUTO-WAH

The Auto Wah cyclically controls a filter to create cyclic change in timbre.

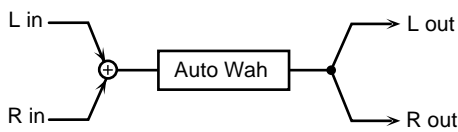
**Filter Type**

Select the type of filter.

LPF : The wah effect will be applied over a wide frequency range.

BPF : The wah effect will be applied over a narrow frequency range.

Sens (Sensitivity)

Adjust the sensitivity with which the filter is controlled.

Manual #

Adjust the center frequency from which the effect is applied.

Peak

Adjust the amount of the wah effect that will occur in the area of the center frequency. Lower settings will cause the effect to be applied in a broad area around the center frequency. Higher settings will cause the effect to be applied in a more narrow range.

Rate #

Adjust the frequency of the modulation.

Depth

Adjust the depth of the modulation.

Level (Output level)

Adjust the output level.

8: ROTARY

The Rotary effect simulates the sound of the rotary speakers often used with the electric organs of the past. Since the movement of the high range and low range rotors can be set independently, the unique type of modulation characteristic of these speakers can be simulated quite closely. This effect is most suitable for electric organ Patches.

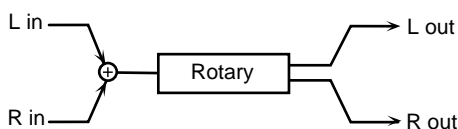
**Low Slow Rate(Low frequency slow rate)**

Adjust the slow speed (SLOW) of the low frequency rotor.

Low Fast Rate (Low frequency fast rate)

Adjust the fast speed (FAST) of the low frequency rotor.

Low Acceleration (Low frequency acceleration)

Adjust the time it takes the low frequency rotor to reach the newly selected speed when switching from fast to slow (or slow to fast) speed. Lower values will require longer times.

Low Level (Low frequency level)

Adjust the volume of the low frequency rotor.

High Slow Rate(High frequency slow rate)

Adjust the slow speed (SLOW) of the high frequency rotor.

High Fast Rate(High frequency fast rate)

Adjust the fast speed (FAST) of the high frequency rotor.

High Acceleration (High frequency acceleration)

Adjust the time it takes the high frequency rotor to reach the newly selected speed when switching from fast to slow (or slow to fast) speed. Lower values will require longer times.

High Level (High frequency level)

Adjust the volume of the high frequency rotor.

Separation

Adjust the spatial dispersion of the sound.

Speed #

Simultaneously switch the rotational speed of the low frequency rotor and high frequency rotor.

SLOW : Slow down the rotation to the specified speed (the Low Slow Rate parameter / Hi Slow Rate parameter values).

FAST : Speed up the rotation to the specified speed (the Low Slow Rate parameter / Hi Slow Rate parameter values).

Level (Output level) #

Adjust the output level.

9: COMPRESSOR

The Compressor flattens out high levels and boosts low levels, smoothing out unevenness in volume.

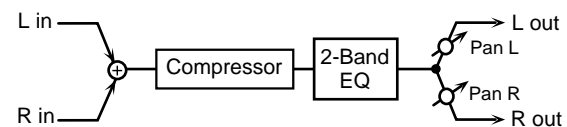
**Attack**

Adjust the attack time of an input sound.

Sustain

Adjust the time over which low level sounds are boosted until they reach the specified volume.

Post Gain

Adjust the output gain.

Low Gain

Adjust the low frequency gain.

High Gain

Adjust the high frequency gain.

Pan (Output pan) #

Adjust the stereo location of the output sound. L64 is far left, 0 is center, and 63R is far right.

Level (Output level) #

Adjust the output level.

10: LIMITER

The Limiter compresses signals that exceed a specified volume level, preventing distortion from occurring.

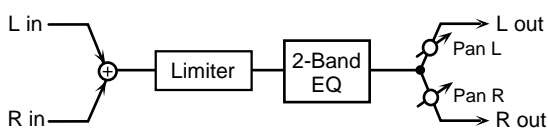
**Threshold (Threshold level)**

Adjust the volume at which compression will begin.

Ratio (Compression ratio)

Adjust the compression ratio.

Release (Release time)

Adjust the time from when the volume falls below the Threshold Level until compression is no longer applied.

Post Gain

Adjust the output gain.

Low Gain

Adjust the low frequency gain.

High Gain

Adjust the high frequency gain.

Pan (Output pan) #

Adjust the stereo location of the output sound. L64 is far left, 0 is center, and 63R is far right.

Level (Output level) #

Adjust the output level.

11: HEXA-CHORUS

Hexa-chorus uses a six-phase chorus (six layers of chorused sound) to give richness and spatial spread to the sound.

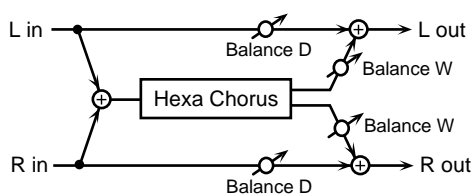
**Pre Delay (Pre delay time)**

Adjust the time delay from when the direct sound begins until the processed sound is heard.

Rate #

Adjust the rate of modulation.

Depth

Adjust the depth of modulation.

Pre Delay Deviation

Pre Delay determines the time from when the direct sound begins until the processed sound is heard. Pre Delay Deviation adjusts the differences in Pre Delay between each chorus sound.

Depth Deviation

Adjust the difference in modulation depth between each chorus sound.

Pan Deviation

Adjust the difference in stereo location between each chorus sound. With a setting of 0, all chorus sounds will be in the center. With a setting of 20, each chorus sound will be spaced at 60 degree intervals relative to the center.

Balance (Effect balance) #

Adjust the volume balance between the direct sound and the processed sound.

Level (Output level)

Adjust the output level.

12: TREMOLO-CHORUS

Tremolo Chorus is a chorus effect with added Tremolo (cyclic modulation of volume).

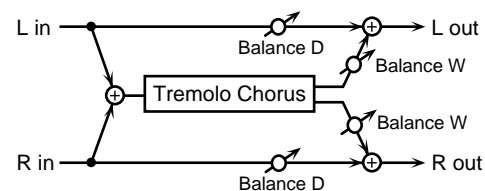
**Pre Delay (Pre delay time)**

Adjust the time delay from when the direct sound begins until the chorus sound is heard.

Chorus Rate

Adjust the modulation speed of the chorus effect.

Chorus Depth

Adjust the modulation depth of the chorus effect.

Chorus Phase

Adjust the spread of the chorus effect.

Tremolo Rate #

Adjust the modulation speed of the tremolo effect.

Tremolo Separation

Adjust the spread of the tremolo effect.

Balance (Effect balance) #

Adjust the volume balance between the direct sound and the processed sound.

Level (Output level)

Adjust the output level.

13: SPACE-D

Space-D is a multiple chorus that applies two-phase modulation in stereo. It gives no impression of modulation, but produces a transparent chorus effect.

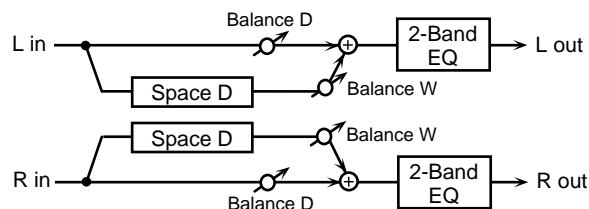
**Pre Delay (Pre delay time)**

Adjust the time delay from when the direct sound begins until the processed sound is heard.

Rate #

Adjust the rate of modulation.

Depth

Adjust the depth of modulation.

Phase

Adjust the spatial spread of the sound.

Low Gain

Adjust the gain of the low frequency range.

High Gain

Adjust the gain of the high frequency range.

Balance (Effect balance) #

Adjust the volume balance between the direct sound and the processed sound.

Level (Output level)

Adjust the output level.

14: STEREO-CHORUS

This is a stereo chorus. A filter is provided so that you can adjust the timbre of the chorus sound.

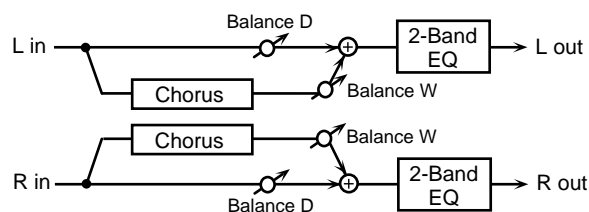
**Pre Delay (Pre delay time)**

Adjust the time delay from when the direct sound begins until the processed sound is heard.

Rate #

Adjust the rate of modulation.

Depth

Adjust the depth of modulation.

Phase

Adjust the spatial spread of the sound.

Filter Type

Select the type of filter.

OFF : A filter will not be used.

LPF : cut the frequency range above the cutoff frequency

HPF : cut the frequency range below the cutoff frequency

Cutoff Freq (Cutoff frequency)

Adjust the basic frequency of the filter.

Low Gain

Adjust the gain of the low frequency range.

High Gain

Adjust the gain of the high frequency range.

Balance (Effect balance) #

Adjust the volume balance between the direct sound and the processed sound.

Level (Output level)

Adjust the output level.

15: STEREO-FLANGER

This is a stereo flanger. (The LFO has the same phase for left and right.) It produces a metallic resonance that rises and falls like a jet airplane taking off or landing. A filter is provided so that you can adjust the timbre of the flanged sound.

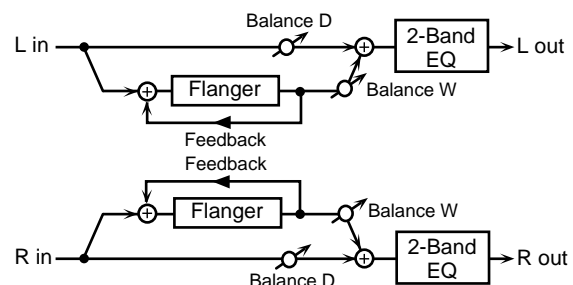
**Pre Delay (Pre delay time)**

Adjust the time delay from when the direct sound begins until the processed sound is heard.

Rate #

Adjust the rate of modulation.

Depth

Adjust the depth of modulation.

Feedback (Feedback level) #

Adjust the amount (%) of the processed sound that is returned (fed back) into the input. Positive (+) settings will return the sound in phase, and negative (-) settings will return the sound in reverse phase.

Phase

Adjust the spatial spread of the sound.

Filter Type

Select the type of filter.

OFF : a filter will not be used

LPF : cut the frequency range above the cutoff frequency

HPF : cut the frequency range below the cutoff frequency

Cutoff Freq(Cutoff frequency)

Adjust the basic frequency of the filter.

Low Gain

Adjust the gain of the low frequency range.

High Gain

Adjust the gain of the high frequency range.

Balance (Effect balance)

Adjust the volume balance between the direct sound and the processed sound.

Level (Output level)

Adjust the output level.

16: STEP-FLANGER

The Step Flanger effect is a flanger in which the flanger pitch changes in steps. The speed at which the pitch changes can also be specified in terms of a note-value of a specified tempo.

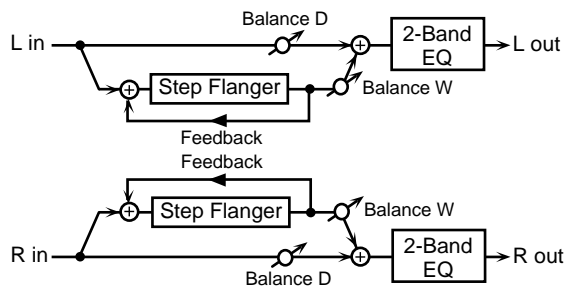

Pre Delay (Pre delay time)

Adjust the time delay from when the direct sound begins until the processed sound is heard.

Rate

Adjust the rate of modulation.

Depth

Adjust the depth of modulation.

Feedback (Feedback level)

Adjust the amount (%) of the processed sound that is returned (fed back) into the input. Negative (-) settings will invert the phase.

Phase

Adjust the spatial spread of the sound.

Step Rate

Adjust the rate (period) of pitch change. This parameter can be set as a note-value of a specified tempo. In this case, specify the value of the desired note.

As the specified tempo, you may use either the Patch Tempo parameter (PATCH/Common/Common General), Performance Tempo (PERFORM/Common/Common), or the tempo clock of the XP-80's sequencer.

If you want to use a fixed tempo in Patch mode (Patch Tempo parameter setting), set the Clock Source parameter (PATCH/Common/Common General) to PATCH and set the desired tempo.

If you want to use the sequencer's tempo clock in Patch mode, set the Clock Source parameter (PATCH/Common/Common General) to SEQUENCER.

If you want to use a fixed tempo in Performance mode (Perform Tempo parameter setting), set the Clock Source parameter (PERFORM/Common/Common) to PERFORM and set the desired tempo.

If you want to use the sequencer's tempo clock in Performance mode, set the Clock Source parameter (PERFORM/Common/Common) to SEQUENCER.

Low Gain

Adjust the gain of the low frequency range.

High Gain

Adjust the gain of the high frequency range.

Balance (Effect balance)

Adjust the volume balance between the direct sound and the processed sound.

Level (Output level)

Adjust the output level.

17: STEREO-DELAY

This is a stereo delay.

When Feedback Mode parameter is NORMAL:

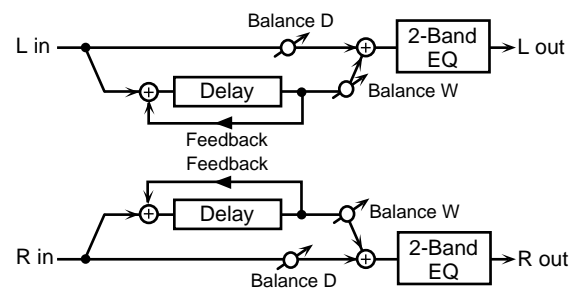

When Feedback Mode parameter is CROSS:

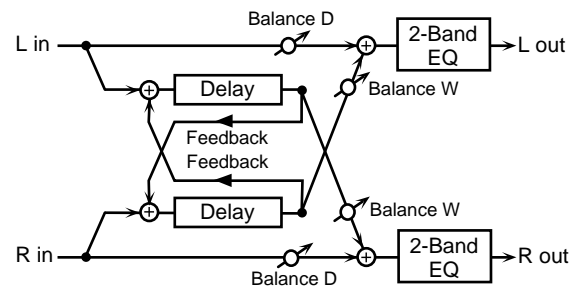

Delay Left (Delay time left)

Adjust the time from the original sound until when the left delay sound is heard.

Delay Right (Delay time right)

Adjust the time from the original sound until when the right delay sound is heard.

Feedback (Feedback level)

Adjust the proportion (%) of the processed sound that is fed back into the effect. Negative (-) settings will invert the phase.

Feedback Mode

Select the way in which processed sound is fed back into the effect.

NORMAL : The left delay sound will be fed back into the left delay, and the right delay sound into the right delay.

CROSS : The left delay sound will be fed back into the right delay, and the right delay sound into the left delay.

Phase Left (Feedback phase left)

Select the phase of the left delay sound.

NORMAL : Phase is not changed.

INVERT : Phase is inverted.

Phase Right (Feedback phase right)

Select the phase of the right delay sound.

NORMAL : Phase is not changed.

INVERT : Phase is inverted.

HF Damp

Adjust the frequency above which sound fed back to the effect will be cut. If you do not want to cut the high frequencies of the feedback, set this parameter to **BYPASS**.

Low Gain

Adjust the gain of the low frequency range.

High Gain

Adjust the gain of the high frequency range.

Balance (Effect balance)

Adjust the volume balance between the direct sound and the processed sound.

Level (Output level)

Adjust the output level.

18: MODULATION-DELAY

This effect adds modulation to the delayed sound, producing an effect similar to a flanger.

When Feedback Mode parameter is **NORMAL**:

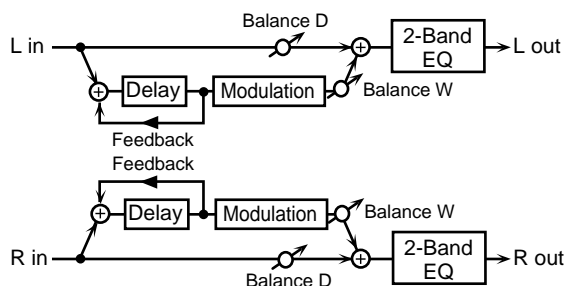

When Feed back Mode parameter is **CROSS**:

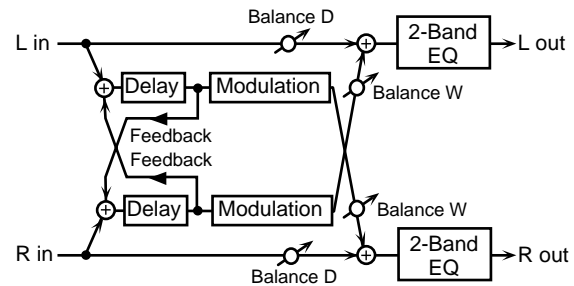

Delay Left (Delay time left)

Adjust the time from the original sound until when the left delay sound is heard.

Delay Right (Delay time right)

Adjust the time from the original sound until when the right delay sound is heard.

Feedback (Feedback level)

Adjust the proportion (%) of the processed sound that is fed back into the effect. Negative (-) settings will invert the phase.

Feedback Mode

Select the way in which processed sound is fed back into the effect.

NORMAL : The left delay sound will be fed back into the left delay, and the right delay sound into the right delay.

CROSS : The left delay sound will be fed back into the right delay, and the right delay sound into the left delay.

Rate

Adjust the speed of the modulation.

Depth

Adjust the depth of the modulation.

Phase

Adjust the spatial spread of the sound.

HF Damp

Adjust the frequency above which sound fed back to the effect will be cut. If you do not want to cut the high frequencies of the feedback, set this parameter to **BYPASS**.

Low Gain

Adjust the gain of the low frequency range.

High Gain

Adjust the gain of the high frequency range.

Balance (Effect balance)

Adjust the volume balance between the direct sound and the processed sound.

Level (Output level)

Adjust the output level.

19: TRIPLE-TAP-DELAY

The Triple Tap Delay produces three delay sounds; center, left and right. The center delay time can be specified as a note value of a specified tempo.

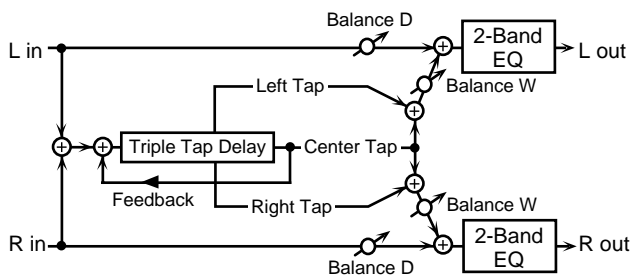

Delay Center (Delay time center)

Adjust the time delay from the direct sound until when the center delay sound is heard. This parameter can be set as a note-value of a specified tempo. In this case, specify the value of the desired note.

Delay Left (Delay time left)

Adjust the time delay from the direct sound until when the left delay sound is heard. This parameter can be set as a note-value of a specified tempo. In this case, specify the value of the desired note.

Delay Right (Delay time right)

Adjust the time delay from the direct sound until when the right delay sound is heard. This parameter can be set as a note-value of a specified tempo. In this case, specify the value of the desired note.

As the specified tempo, you may use either the Patch Tempo parameter (PATCH/Common/Common General), Performance Tempo (PERFORM/Common/Common), or the tempo clock of the XP-80's sequencer.

If you want to use a fixed tempo in Patch mode (Patch Tempo parameter setting), set the Clock Source parameter (PATCH/Common/Common General) to PATCH and set the desired tempo.

If you want to use the sequencer's tempo clock in Patch mode, set the Clock Source parameter (PATCH/Common/Common General) to SEQUENCER.

If you want to use a fixed tempo in Performance mode (Perform Tempo parameter setting), set the Clock Source parameter (PERFORM/Common/Common) to PERFORM and set the desired tempo.

If you want to use the sequencer's tempo clock in Performance mode, set the Clock Source parameter (PERFORM/Common/Common) to SEQUENCER.

Feedback (Feedback level) #

Adjust the proportion (%) of the processed sound that is fed back into the effect. Negative (-) settings will invert the phase.

Center Level

Adjust the volume of center delay sound.

Left Level

Adjust the volume of left delay sound.

Right Level

Adjust the volume of right delay sound.

HF Damp

Adjust the frequency above which sound fed back to the effect will be cut. If you do not want to cut the high frequencies of the feedback, set this parameter to BYPASS.

Low Gain

Adjust the gain of the low frequency range.

High Gain

Adjust the gain of the high frequency range.

Balance (Effect balance) #

Adjust the volume balance between the direct sound and the processed sound.

Level (Output level)

Adjust the output level.

20: QUADRUPLE-TAP-DELAY

The Quadruple Tap Delay has four delays. Each of the Delay Time parameters can be specified as a note length of the selected tempo.

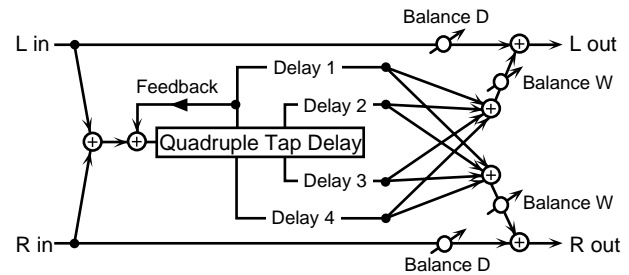

The stereo location of each delay sound is as follows.

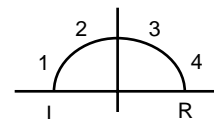

Delay 1 (Delay time 1)

Delay 2 (Delay time 2)

Delay 3 (Delay time 3)

Delay 4 (Delay time 4)

Adjust the time delay from the direct sound until when each delay sound is heard. These parameters can be set as a note-value of a specified tempo. In this case, specify the value of the desired note.

As the specified tempo, you may use either the Patch Tempo parameter (PATCH/Common/Common General), Performance Tempo (PERFORM/Common/Common), or the tempo clock of the XP-80's sequencer.

If you want to use a fixed tempo in Patch mode (Patch Tempo parameter setting), set the Clock Source parameter (PATCH/Common/Common General) to PATCH and set the desired tempo.

If you want to use the sequencer's tempo clock in Patch mode, set the Clock Source parameter (PATCH/Common/Common General) to SEQUENCER.

If you want to use a fixed tempo in Performance mode (Perform Tempo parameter setting), set the Clock Source parameter (PERFORM/Common/Common) to PERFORM and set the desired tempo.

If you want to use the sequencer's tempo clock in Performance mode, set the Clock Source parameter (PERFORM/Common/Common) to SEQUENCER.

- Level 1
- Level 2
- Level 3
- Level 4

Adjust the volume of each delay sound.

Feedback (Feedback level) #

Adjust the proportion (%) of the processed sound that is fed back into the effect. Negative (-) settings will invert the phase.

HF Damp

Adjust the frequency above which sound fed back to the effect will be cut. If you do not want to cut the high frequencies of the feedback, set this parameter to BYPASS.

Balance (Effect balance) #

Adjust the volume balance between the direct sound and the processed sound.

Level (Output level)

Adjust the output level.

21: TIME-CONTROL-DELAY

This effect allows you to use a specified controller (the controller selected in EFX Control display) to control the delay time and pitch in realtime. Lengthening the delay will lower the pitch, and shortening it will raise the pitch.

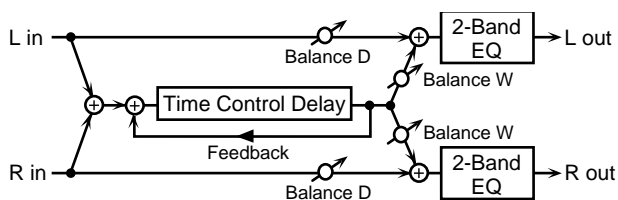

Delay (Delay time) #

Adjust the time delay from the direct sound until when each delay sound is heard.

Acceleration

This parameter adjusts the time over which the Delay Time will change from the current setting to a newly specified setting. The rate of change for the Delay Time directly affects the rate of pitch change.

Feedback (Feedback level) #

Adjust the proportion (%) of the processed sound that is fed back into the effect. Negative (-) settings will invert the phase.

HF Damp

Adjust the frequency above which sound fed back to the effect will be cut. If you do not want to cut the high frequencies of the feedback, set this parameter to BYPASS.

Pan (Output pan)

Adjust the stereo location of the processed sound. L64 is far left, 0 is center, and 63R is far right.

Low Gain

Adjust the gain of the low frequency range.

High Gain

Adjust the gain of the high frequency range.

Balance (Effect balance)

Adjust the volume balance between the direct sound and the processed sound.

Level (Output level)

Adjust the output level.

22: 2VOICE-PITCH-SHIFTER

A Pitch Shifter shifts the pitch of the original sound. This 2-voice pitch shifter has two pitch shifters, and can add two pitch shifted sounds to the original sound.

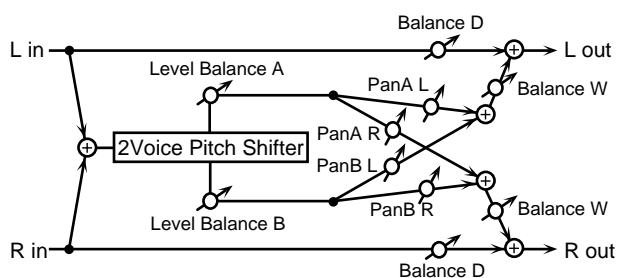

Coarse A (Coarse pitch A) #

Adjust the pitch of Pitch Shift A in semitone steps (-2—+1 octaves).

Fine A (Fine pitch A)

Make fine adjustments to the pitch of Pitch Shift A in 2-cent steps (-100—+100 cents).

* One cent is 1/100th of a semitone.

Pan A (Output pan A)

Adjust the stereo location of the Pitch Shift A sound. L64 is far left, 0 is center, and 63R is far right.

Pre Delay A (Pre delay time A)

Adjust the time delay from when the direct sound begins until the Pitch Shift A sound is heard.

Coarse B (Coarse pitch B) #

Adjust the pitch of Pitch Shift B in semitone steps (-2—+1 octaves).

Fine B (Fine pitch B)

Make fine adjustments to the pitch of Pitch Shift B in 2-cent steps (-100—+100 cents).

Pan B (Output pan B)

Adjust the stereo location of the Pitch Shift B sound. L64 is far left, 0 is center, and 63R is far right.

Pre Delay B (Pre delay time B)

Adjust the time delay from when the direct sound begins until the Pitch Shift A sound is heard.

Mode (Pitch shifter mode)

Higher settings of this parameter will result in slower response, but steadier pitch.

Level Balance

Adjust the volume balance between the Pitch Shift A and Pitch Shift B sounds.

Balance (Effect balance)

Adjust the volume balance between the direct sound and the processed sound.

Level (Output level)

Adjust the output level.

23: FBK-PITCH-SHIFTER (Feedback pitch shifter)

This pitch shifter allows the pitch shifted sound to be fed back into the effect.

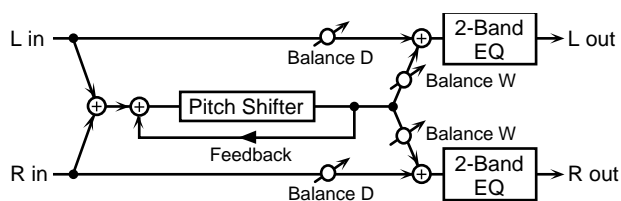

Coarse (Coarse pitch)

Adjust the pitch of the pitch shifted sound in semitone steps (-2—+1 octaves).

Fine (Fine pitch)

Make fine adjustments to the pitch of the pitch shifted sound in 2-cent steps (-100—+100 cents).

Pan (Output pan)

Adjust the stereo location of the pitch shifted sound. L64 is far left, 0 is center, and 63R is far right.

Pre Delay (Pre delay time)

Adjust the time delay from when the direct sound begins until the pitch shifted sound is heard.

Mode (Pitch shifter mode)

Higher settings of this parameter will result in slower response, but steadier pitch.

Feedback (Feedback level)

Adjust the proportion (%) of the processed sound that is fed back into the effect. Negative (-) settings will invert the phase.

Low Gain

Adjust the gain of the low frequency range.

High Gain

Adjust the gain of the high frequency range.

Balance (Effect balance)

Adjust the volume balance between the direct sound and the processed sound.

Level (Output level)

Adjust the output level.

24: REVERB

The Reverb effect adds reverberation to the sound, simulating an acoustic space.

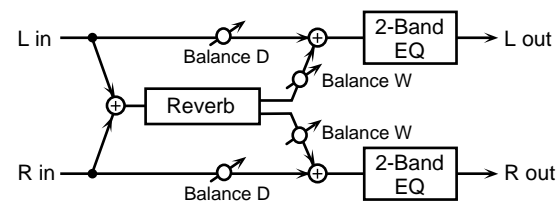

Type (Reverb type)

Select the type of Reverb effect.

ROOM1 : dense reverb with short decay

ROOM2 : sparse reverb with short decay

STAGE1 : reverb with greater late reverberation

STAGE2 : reverb with strong early reflections

HALL1 : reverb with clear reverberance

HALL2 : reverb with rich reverberance

Pre Delay (Pre delay time)

Adjust the time delay from when the direct sound begins until the reverb sound is heard.

Time (Reverb time)

Adjust the time length of reverberation.

HF Damp

Adjust the frequency above which the reverberant sound will be cut. As the frequency is set lower, more of the high frequencies will be cut, resulting in a softer and more muted reverberance. If you do not want the high frequencies to be cut, set this parameter to BYPASS.

Low Gain

Adjust the gain of the low frequency range.

High Gain

Adjust the gain of the high frequency range.

Balance (Effect balance)

Adjust the volume balance between the direct sound and the processed sound.

Level (Output level)

Adjust the output level.

25: GATE-REVERB

Gate Reverb is a special type of reverb in which the reverberant sound is cut off before its natural length.

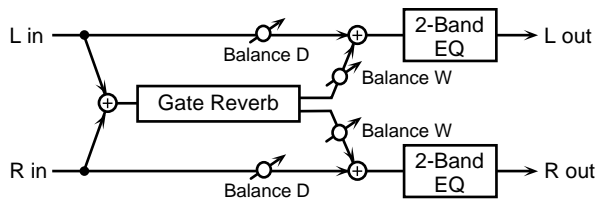

Type (Gate reverb type)

Select the type of reverb.

NORMAL : conventional gate reverb

REVERSE : backwards reverb

SWEEP1 : the reverberant sound moves from right to left

SWEEP2 : the reverberant sound moves from left to right

Pre Delay (Pre delay time)

Adjust the time delay from when the direct sound begins until the reverb sound is heard.

Gate Time

Adjust the time from when the reverb is heard until when it disappears.

Low Gain

Adjust the gain of the low frequency range.

High Gain

Adjust the gain of the high frequency range.

Balance (Effect balance)

Adjust the volume balance between the direct sound and the processed sound.

Level (Output level)

Adjust the output level.

26: OVERDRIVE → CHORUS

This effect connects an overdrive and a chorus in series.

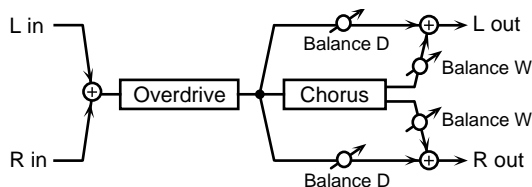

OD Drive

Adjust the degree of overdrive distortion. The volume will change together with the degree of distortion.

OD Pan (Output pan)

Adjust the stereo location of the overdrive sound. L64 is far left, 0 is center, and 63R is far right.

Chorus Pre Delay (Chorus pre delay time)

Adjust the time delay from when the direct sound begins until the chorus sound is heard.

Chorus Rate

Adjust the modulation speed of the chorus effect.

Chorus Depth

Adjust the modulation depth of the chorus effect.

Chorus Balance

Adjust the volume balance between the overdrive sound that is sent through the chorus and the overdrive sound that is not sent through the chorus. With a setting of "D100: 0E," only the overdrive sound will be output. With a setting of "D0: 100E," only the overdrive sound that is sent through the chorus will be output.

Level (Output level)

Adjust the output level.

27: OVERDRIVE → FLANGER

This effect connects an overdrive and a flanger in series.

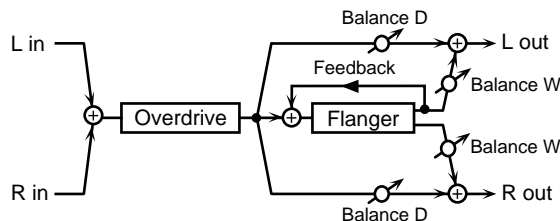

OD Drive

Adjust the degree of overdrive distortion. The volume will change together with the degree of distortion.

OD Pan (Output pan)

Adjust the stereo location of the overdrive sound. L64 is far left, 0 is center, and 63R is far right.

Flanger Pre Delay (Flanger pre delay time)

Adjust the time delay from when the direct sound begins until the flanger sound is heard.

Flanger Rate

Adjust the modulation speed of the flanger effect.

Flanger Depth

Adjust the modulation depth of the flanger effect.

Flanger Feedback (Flanger feedback level)

Adjust the proportion (%) of the flanger sound that is fed back into the effect. Negative (-) settings will invert the phase.

Flanger Balance

Adjust the volume balance between the overdrive sound that is sent through the flanger and the overdrive sound that is not sent through the flanger. With a setting of "D100: 0E," only the overdrive sound will be output. With a setting of "D0: 100E," only the overdrive sound that is sent through the flanger will be output.

Level (Output level)

Adjust the output level.

28: OVERDRIVE → DELAY

This effect connects an overdrive and a delay in series.

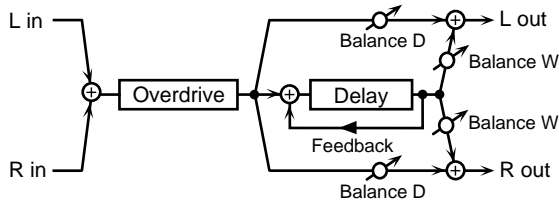

OD Drive

Adjust the degree of overdrive distortion. The volume will change together with the degree of distortion.

OD Pan (Output pan) #

Adjust the stereo location of the overdrive sound. L64 is far left, 0 is center, and 63R is far right.

Delay Time

Adjust the time delay from when the direct sound begins until the delay sound is heard.

Delay Feedback (Delay feedback level)

Adjust the proportion (%) of the delay sound that is fed back into the effect. Negative (-) settings will invert the phase.

Delay HF Damp

Adjust the frequency above which delayed sound fed back to the effect will be cut. If you do not want to cut the high frequencies of the feedback, set this parameter to BYPASS.

Delay Balance #

Adjust the volume balance between the overdrive sound that is sent through the delay and the overdrive sound that is not sent through the delay. With a setting of "D100: 0E," only the overdrive sound will be output. With a setting of "D0: 100E," only the overdrive sound that is sent through the delay will be output.

Level (Output level)

Adjust the output level.

29: DISTORTION → CHORUS

This effect connects a distortion and a chorus in series. The parameters are the same as for "26: OVERDRIVE → CHORUS."

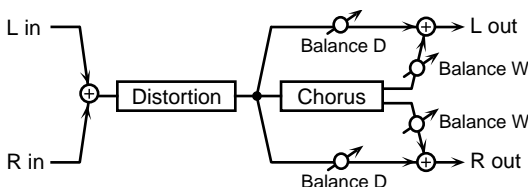

30: DISTORTION → FLANGER

This effect connects a distortion and a flanger in series. The parameters are the same as for "27: OVERDRIVE → FLANGER."

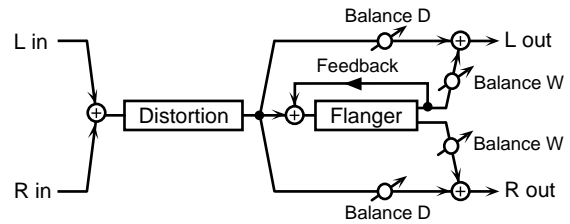

31: DISTORTION → DELAY

This effect connects a distortion and a delay in series. The parameters are the same as for "28: OVERDRIVE → DELAY."

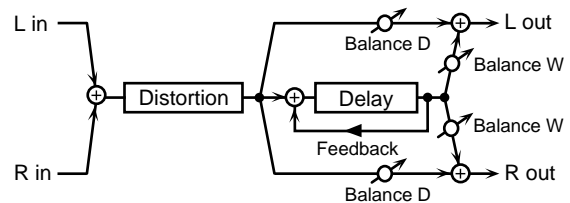

32: ENHANCER → CHORUS

This effect connects an enhancer and a chorus in series.

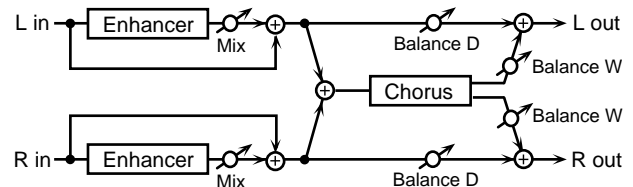

EH Sens (Enhancer Sensitivity) #

Adjust the sensitivity of the enhancer.

EH Mix (Enhancer Mix level)

Adjust the ratio with which the overtones generated by the enhancer are combined with the direct sound.

Chorus Pre Delay (Chorus pre delay time)

Adjust the time delay from when the direct sound begins until the chorus sound is heard.

Chorus Rate

Adjust the modulation speed of the chorus effect.

Chorus Depth

Adjust the modulation depth of the chorus effect.

Chorus Balance #

Adjust the volume balance between the enhancer sound that is sent through the chorus and the enhancer sound that is not sent through the chorus. With a setting of "D100: 0E," only the enhancer sound will be output. With a setting of "D0: 100E," only the enhancer sound that is sent through the chorus will be output.

Level (Output level)

Adjust the output level.

33: ENHANCER → FLANGER

This effect connects an enhancer and a flanger in series.

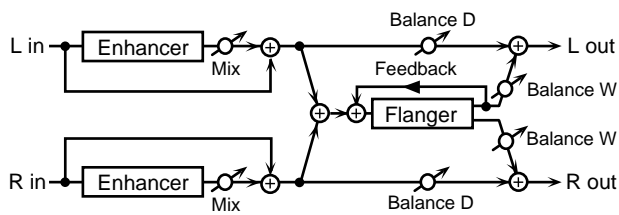

EH Sens (Enhancer Sensitivity)

Adjust the sensitivity of the enhancer.

EH Mix (Enhancer Mix level)

Adjust the ratio with which the overtones generated by the enhancer are combined with the direct sound.

Flanger Pre Delay (Flanger pre delay time)

Adjust the time delay from when the direct sound begins until the flanger sound is heard.

Flanger Rate

Adjust the modulation speed of the flanger effect.

Flanger Depth

Adjust the modulation depth of the flanger effect.

Flanger Feedback (Flanger Feedback level)

Adjust the proportion (%) of the flanger sound that is fed back into the effect. Negative (-) settings will invert the phase.

Flanger Balance

Adjust the volume balance between the enhancer sound that is sent through the flanger and the enhancer sound that is not sent through the flanger. With a setting of "D100: 0E," only the enhancer sound will be output. With a setting of "D0: 100E," only the enhancer sound that is sent through the flanger will be output.

Level (Output level)

Adjust the output level.

34: ENHANCER → DELAY

This effect connects an enhancer and a delay in series.

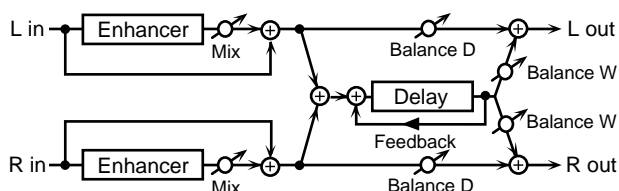

EH Sens (Enhancer Sensitivity)

Adjust the sensitivity of the enhancer.

EH Mix (Enhancer Mix level)

Adjust the ratio with which the overtones generated by the enhancer are combined with the direct sound.

Delay Time

Adjust the time delay from when the direct sound begins until the delay sound is heard.

Delay Feedback (Delay feedback level)

Adjust the proportion (%) of the delay sound that is fed back into the delay input. Negative (-) settings will invert the phase.

Delay HF Damp

Adjust the frequency above which delayed sound fed back to the delay input will be cut. If you do not want to cut the high frequencies of the delay feedback, set this parameter to BYPASS.

Delay Balance (Delay balance)

Adjust the volume balance between the enhancer sound that is sent through the delay and the enhancer sound that is not sent through the delay. With a setting of "D100: 0E," only the enhancer sound will be output. With a setting of "D0: 100E," only the enhancer sound that is sent through the delay will be output.

Level (Output level)

Adjust the output level.

35: CHORUS → DELAY

This effect connects a chorus and a delay unit in series.

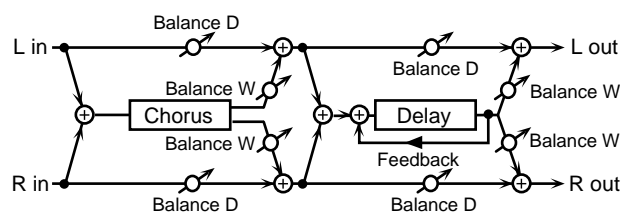

Chorus Pre Delay (Chorus pre delay time)

Adjust the time delay from when the direct sound begins until the chorus sound is heard.

Chorus Rate

Adjust the modulation speed of the chorus effect.

Chorus Depth

Adjust the modulation depth of the chorus effect.

Chorus Balance

Adjust the volume balance between the direct sound and the chorus sound. With a setting of "D100: 0E," only the direct sound will be output. With a setting of "D0: 100E," only the chorus sound will be output.

Delay Time

Adjust the time delay from when the direct sound begins until the delay sound is heard.

Delay Feedback (Delay feedback level)

Adjust the proportion (%) of the delay sound that is fed back into the delay input. Negative (-) settings will invert the phase.

Delay HF Damp

Adjust the frequency above which delayed sound fed back to the delay input will be cut. If you do not want to cut the high frequencies of the feedback, set this parameter to BYPASS.

Delay Balance

Adjust the volume balance between the chorus sound that is sent through the delay and the chorus sound that is not sent through the delay. With a setting of "D100: 0E," only the chorus sound will be output. With a setting of "D0: 100E," only the chorus sound that is sent through the delay will be output.

Level (Output level)

Adjust the output level.

36: FLANGER → DELAY

This effect connects a flanger and a delay in series.

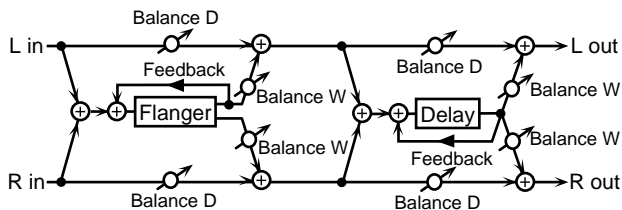

Flanger Pre Delay (Flanger pre delay time)

Adjust the time delay from when the direct sound begins until the flanger sound is heard.

Flanger Rate

Adjust the modulation speed of the flanger effect.

Flanger Depth

Adjust the modulation depth of the flanger effect.

Flanger Feedback (Flanger feedback level)

Adjust the proportion (%) of the flanger sound that is fed back into the effect. Negative (-) settings will invert the phase.

Flanger Balance

Adjust the volume balance between the direct sound and the flanger sound. With a setting of "D100: 0E," only the direct sound will be output. With a setting of "D0: 100E," only the flanger sound will be output.

Delay Time

Adjust the time delay from when the direct sound begins until the delay sound is heard.

Delay Feedback (Delay feedback level)

Adjust the proportion (%) of the delay sound that is fed back into the delay input. Negative (-) settings will invert the phase.

Delay HF Damp

Adjust the frequency above which delayed sound fed back to the delay input will be cut. If you do not want to cut the high frequencies of the delay feedback, set this parameter to BYPASS.

Delay Balance

Adjust the volume balance between the flanger sound that is sent through the delay and the flanger sound that is not sent through the delay. With a setting of "D100: 0E," only the flanger sound will be output. With a setting of "D0: 100E," only the flanger sound that is sent through the delay will be output.

Level (Output level)

Adjust the output level.

37: CHORUS → FLANGER

This effect connects a chorus and a flanger in series.

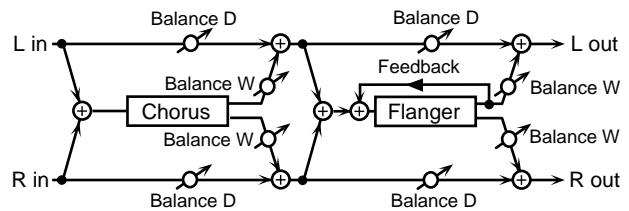

Chorus Pre Delay (Chorus pre delay time)

Adjust the time delay from when the direct sound begins until the chorus sound is heard.

Chorus Rate

Adjust the modulation speed of the chorus effect.

Chorus Depth

Adjust the modulation depth of the chorus effect.

Chorus Balance

Adjust the volume balance between the direct sound and the chorus sound. With a setting of "D100: 0E," only the direct sound will be output. With a setting of "D0: 100E," only the chorus sound will be output.

Flanger Pre Delay (Flanger pre delay time)

Adjust the time delay from when the direct sound begins until the flanger sound is heard.

Flanger Rate

Adjust the modulation speed of the flanger effect.

Flanger Depth

Adjust the modulation depth of the flanger effect.

Flanger Feedback (Flanger feedback level)

Adjust the proportion (%) of the flanger sound that is fed back into the effect. Negative (-) settings will invert the phase.

Flanger Balance

Adjust the volume balance between the chorus sound and the chorus sound that is passed through the flanger. With a setting of "D100: 0E," only the chorus sound will be output. With a setting of "D0: 100E," only the chorus sound that passes through the flanger will be output.

Level (Output level)

Adjust the output level.

38: CHORUS/DELAY

This effect connects a chorus and a delay in parallel. The parameters are the same as for “35: CHORUS → DELAY.” However, the Delay Balance parameter adjusts the volume balance between the direct sound and the delay sound.

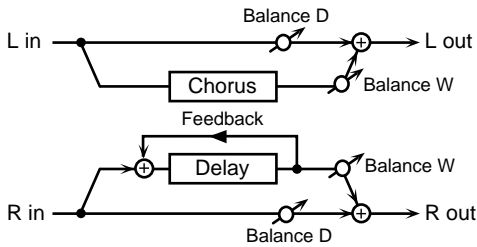

39: FLANGER/DELAY

This effect connects a flanger and a delay in parallel. The parameters are the same as for “36: FLANGER → DELAY.” However, the Delay Balance parameter adjusts the volume balance between the direct sound and the delay sound.

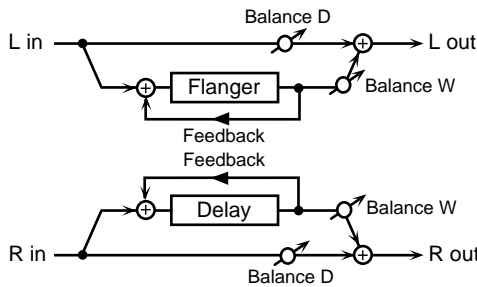

40: CHORUS/FLANGER

This effect connects a chorus and a flanger in parallel. The parameters are the same as for “37: CHORUS → FLANGER.” However, the Flanger Balance parameter adjusts the volume balance between the direct sound and the flanger sound.

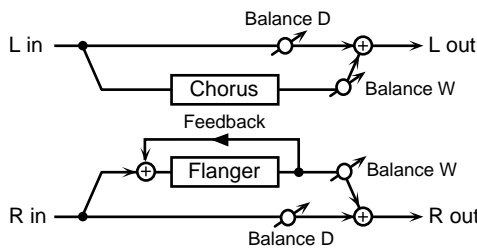

XP-80 operating environment setup (System parameters and their functions)

* System mode settings will be retained until they are reset the next time.

Setups and keyboard settings (Setup)

Setup display

This display is used when you adjust display brightness and set keyboard touch, etc.

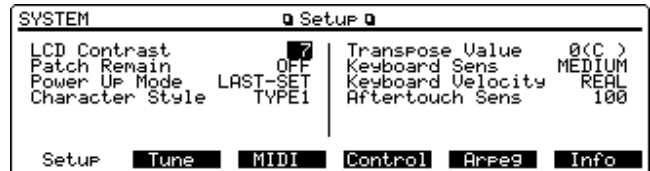

LCD Contrast

Adjusts display screen contrast (brightness). Higher values make display brighter.

Patch Remain (Patch remain switch)

Specifies whether you want the notes that are sounding to remain (ON) or turn off (OFF) when you select a new Patch or Rhythm Set.

Power Up Mode

Specifies how you want the state of the XP-80 when power is turned on.

LAST-SET: The XP-80 remains in the state it was when power was turned off.

DEFAULT: The XP-80 will be ready to play Patch USER:001.

Character Style

Selects large character type (for Patch names, file names, etc.) shown on each mode's Play display.

TYPE 1: Bold characters of equal width

TYPE 2: Light characters of equal width

TYPE 3: Bold characters of differing widths

TYPE 4: Light characters of differing widths

Transpose Value

If you wish to transpose the range of the keyboard, this parameter specifies the transpose amount in semitones. Tonic is indicated in parentheses ().

* When transposing the keyboard range, press [TRANSPPOSE] and indicator lights.

* The octave-shift amount and the transpose amount are shown at lower left in each source's Play display.

* To change transpose amount on a Play display, hold down [TRANSPPOSE] and press [-OCT] or [+OCT].

Keyboard Sens (Keyboard sensitivity)

Specifies keyboard touch.

LIGHT: Light

MEDIUM: Normal

HEAVY: Heavy

Keyboard Velocity

Specifies the velocity value to be transmitted when you play the keyboard. If you want actual keyboard velocity to be transmitted, set this to REAL. For a fixed velocity value to be transmitted regardless of how you play, specify value desired.

Aftertouch Sens (Aftertouch sensitivity)

Specifies aftertouch sensitivity. Higher values allow aftertouch to be easier applied. Default setting is 100.

* If "Internal Memory Full!" appears during song recording, it may be helpful to reset this parameter to a smaller value.

Adjusting tuning (Tune)

Tune display

On this display you can tune the XP-80 and change the scale of the keyboard.



Master Tune

Sets overall tuning of the XP-80's sound source. A4 key frequency is displayed as the tuning value.

Master Key Shift

Specifies sound source's scale pitch in semitones.

Switch (Scale tune switch)

Set this parameter ON when playing the keyboard in a scale other than equal temperament.

Scale Tune

You can set the scale graphically on the display. To set a scale, specify the amount of pitch to be shifted for each note relative to the pitch of the equal temperament scale in 1-cent units.

Two scales can be set – one for Patch mode, and the other one for Performance, Rhythm Set and GM modes.

When setting the keyboard scale in Patch mode, press [SYSTEM] in Patch mode and press [F2] (Tune) to call up the Tune display. Tuning the notes of a single octave (C–B) will tune the pitch of all octaves. When setting a scale in other modes, press [SYSTEM] in the respective mode and press [F2] (Tune) to call up the Tune display. If the notes of a single octave (C–B) are tuned, the pitch of all octaves (for the Part currently selected) will be tuned. To set pitch tuning for

another Part, select the Part by pressing the corresponding TRACK/PART [1]–[16] button.

* 1 cent is 1/100th of a semitone.

<Equal Temperament>

This scale divides an octave into 12 equal parts for the tuning system that is most widely used in Western music. The XP-80 employs equal temperament when the Switch parameter is set OFF.

<Pure Temperament (Tonic is C)>

With this tuning, the three fundamental chords sound richer compared to equal temperament. This effect only applies to one key, and transposition makes the chord ambiguous.

<Arabian Scale>

In this scale, E and B are a quarter-note lower and C#, F# and G# are quarter-note higher compared to equal temperament. The intervals between G and B, C and E, F and G#, A# and C#, and D# and F# have a natural third (the interval between a major third and a minor third). With the XP-80, you can play Arabian scale in G, C and F keys.

(Examples)

Note name	Equal temperament	Pure temperament (tonic C)	Arabian scale
C	0	0	-6
C#	0	-8	+45
D	0	+4	-2
D#	0	+16	-12
E	0	-14	-51
F	0	-2	-8
F#	0	-10	+43
G	0	+2	-4
G#	0	+14	+47
A	0	-16	0
A#	0	+14	-10
B	0	-12	-49

MIDI settings (MIDI)

- * MIDI Param1 display varies depending on the sound source mode selected prior to [SYSTEM] being pressed. Other displays are common to all modes.
- * The MIDI group consists of three display pages: MIDI Param 1, MIDI Param 2 and Bank Select Group. To change the display page, press [F3] (MIDI).

MIDI Param1 (Performance MIDI Parameter 1) display

When [SYSTEM] is pressed in Performance mode (or Rhythm Set mode), the following display will appear.

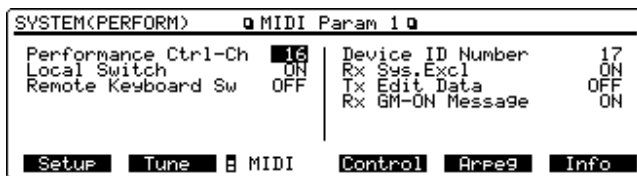

- * It is also possible to set the Performance Ctrl-Ch and Local Switch parameters in the System Parameter window you open by pressing [LOCAL/TX/RX] then [F2] (System) in Performance mode.

Performance Ctrl-Ch (Control channel)

Selects the receive channel used for selecting Performances via MIDI messages (Bank Select and Program Change messages). If you don't want to use Program Change messages to select Performances, set this OFF. If you set this control to the same channel as the receive channel for a Part specified by the Channel parameter (PERFORM/MIDI/Part MIDI), Performance selection will have priority and Program Change messages cannot be used for selecting Patches on that Part.

- * This setting is displayed for "Ctrl-Ch=" at the upper right of the Play display (PERFORM).

Local Switch

Specifies whether all Parts will be played by the keyboard (ON) or not (OFF). Normally this is left ON, but if you wish to use the XP-80's keyboard and controllers to control only external sound sources, set it OFF.

- * If you want the keyboard to disconnect only from a specific Part or Parts, use the Local Sw parameter (PERFORM/MIDI/MIDI Param).

Remote Keyboard Sw (Remote keyboard switch)

Set this parameter ON for using an external MIDI keyboard instead of the XP-80's keyboard. In this case, the transmit channel of the external MIDI keyboard can be set to any channel. Normally this parameter is left OFF.

- * Set this parameter ON if you want performance using the RPS function to be controlled by an external MIDI device.

Device ID Number

For transmitting or receiving System Exclusive messages, set this parameter to match the device ID number of the other MIDI device.

Rx Sys.Excl (Receive system exclusive switch)

Set ON if you want System Exclusive messages to be received. If not, set OFF.

Tx Edit Data (Transmit edit data switch)

If you want System Exclusive messages to be transmitted for each change you make while editing a Patch, Performance or Rhythm Set, set this ON. If not, set it OFF.

Rx GM-ON Message (Receive GM-ON switch)

Set ON for receiving GM-ON messages. Otherwise set OFF.

MIDI Param1 (Patch MIDI Parameter 1) display

When [SYSTEM] is pressed in Patch mode, the following display will appear.

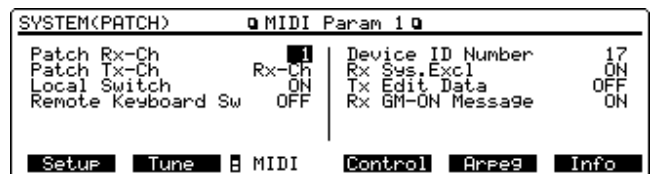

- * You can also set the Patch Rx-Ch, Patch Tx-Ch and Local Switch parameters in the System Parameter window you open by pressing [LOCAL/TX/RX] in Patch mode.

Patch Rx-Ch (Patch receive channel)

Specifies the channel on which MIDI messages will be received in Patch mode.

- * This setting is displayed for "Rx=" at the upper right of the Play display (PATCH).

Patch Tx-Ch (Patch transmit channel)

Specifies the channel on which MIDI messages will be transmitted in Patch mode. Set OFF if you're not going to be sending MIDI messages to external MIDI devices. If you always want the transmit channel to match the Patch Rx-Ch parameter setting, set this parameter to Rx-Ch.

- * This setting is displayed for "Tx=" at the upper right of the Play display (PATCH).

Local Switch

Specifies whether sounds will be produced by the keyboard (ON) or not (OFF). Normally set ON, but set OFF when using the XP-80's keyboard and controllers solely to control external sound sources.

Remote Keyboard Switch

Set this parameter ON when you want to use an external MIDI keyboard instead of the XP-80's keyboard. In this case, the transmit channel of the external MIDI keyboard can be set to any channel. Normally this parameter should be OFF.

- * Set this parameter ON for performance using the RPS function to be controlled by an external MIDI device.

Device ID Number

When transmitting or receiving System Exclusive messages, set this parameter to match the device ID number of the other MIDI device.

Rx Sys. Excl (Receive system exclusive switch)

For receiving System Exclusive messages, set this ON. If not, set it OFF.

Tx Edit Data (Transmit edit data switch)

If you want System Exclusive messages to be transmitted for each change you make while editing a Patch, Performance or Rhythm Set, set this ON. If not, set it OFF.

Rx GM-ON Message (Receive GM-ON switch)

If you want to receive GM-ON messages, set this ON. If not, set it OFF.

MIDI Param1 (GM MIDI Parameter) display

When [SYSTEM] is pressed in GM mode, the following display will appear.

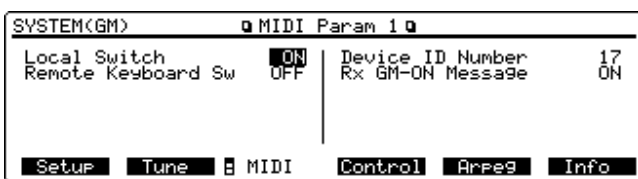

Local Switch

Specifies whether all Parts will be played by the keyboard (ON) or not (OFF). Normally left ON, but if you use the XP-80's keyboard and controllers for controlling only external sound sources, set this OFF.

- * It is also possible to set the Local Switch parameters in the System Parameter window you open by pressing [LOCAL/TX/RX] then [F2] (System).

Remote Keyboard Switch

Set this parameter ON when you want to use an external MIDI keyboard instead of the XP-80's keyboard. In this case, the transmit channel of the external MIDI keyboard can be set to any channel. Normally this parameter should be OFF.

- * Set this parameter ON for performance using the RPS function to be controlled by an external MIDI device.

Device ID Number

For transmitting or receiving System Exclusive messages, set this parameter to match the device ID number of the other MIDI device.

Rx GM-ON Message (Receive GM-ON switch)

If you want to receive GM-ON messages, set this ON. If not, set it OFF.

MIDI Param 2 (MIDI parameter 2) display

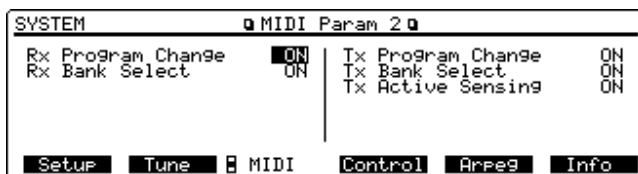

Rx Program Change (Receive program change switch)

If you want to receive Program Change messages, set this ON. If not, set it OFF.

Rx Bank Select (Receive bank select switch)

If you want to receive Bank Select messages, set this ON. If not, set it OFF.

Tx Program Change (Transmit program change switch)

If you want to send Program Change messages, set this ON. If not, set it OFF.

Tx Bank Select (Transmit bank select switch)

If you want to send Bank Select messages, set this ON. If not, set it OFF.

Tx Active Sensing (Transmit active sensing switch)

If you want to transmit Active Sensing messages, set this ON. If not, set it OFF.

Bank Select Group display

If you have selected GROUP1–GROUP7 for the Tx Bank Select parameter (PERFORM/MIDI/MIDI Param), the Bank Select Group parameter specifies the Bank Select number to be transmitted for Grp1–Grp7 parameters.

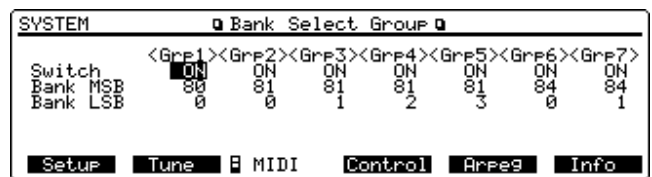

Grp1-Grp7 (Bank select group number 1–7)

Set Bank MSB and Bank LSB for each of <Grp1>–<Grp7> (group number). Use the Switch parameter to specify whether Bank Select messages of each group will be transmitted (ON) or not (OFF).

Assigning sliders, pedals and other controllers (Control)

- * The Control group consists of three display pages – Control Assign, Pedal Assign and Control Source. To change the display page, press [F4] (Control).

Control Assign display

This display is for assigning the function of each slider.



C1 Slider

C2 Slider

Specifies the function of the C1 slider and C2 slider, respectively.

Use the Assign parameter to specify the functions controlled by each slider.

CC01–95: Controller numbers 1–95 (except for 6, 32–63).

PITCH BEND: Pitch bend

AFTERTOUCH: Aftertouch

Use the Output parameter to select the sound source(s) (the internal sound source and/or external sound sources connected to MIDI OUT connector) to be controlled by the sliders.

OFF: Neither will be controlled.

INT: Only the internal sound source will be controlled.

MIDI: Only external sound sources will be controlled.

INT&MIDI: Both the internal sound source and external sound sources will be controlled.

Sys-Ctrl1 (System Controller 1)

Sys-Ctrl2 (System Controller 2)

These parameters allow you to choose up to two controllers for common use for controlling Patch or Performance parameters. The settings in each Patch (or Performance) determines which of the two controllers you choose here will actually be used. You also need to specify the parameters to be controlled for each Patch (or Performance).

Use the Assign parameter to specify functions controlled by each slider.

CC01–95: Controller numbers 1–95 (except for 6, 32–63).

PITCH BEND: Pitch bend

AFTERTOUCH: Aftertouch

- * To use the selected controllers, you need to make necessary System settings and Patch/Performance settings so that the MIDI messages transmitted by the selected controllers will be received.

- * For most control change messages, the function performed by message number is defined in MIDI specifications. Please note these settings allow you to use control change messages without regard to officially defined functions.

Pedal Assign display

Use this display for assigning functions to the pedals.



Pedal 1–Pedal 4

Hold Pedal

Specifies the functions of Pedals 1–4 and the Hold Pedal.

Use the Assign parameter to specify the functions controlled by each pedal.

- * Hold Pedal's Assign is fixed at CC64: HOLD-1.

CC01–95: Controller numbers 1–95 (except for 6, 32–63).

PITCH BEND: Pitch bend

AFTERTOUCH: Aftertouch

PROG-UP: Every press of the pedal selects the next Performance number, Patch number, or Rhythm Set.

PROG-DOWN: Every press of the pedal selects the previous Performance number, Patch number, or Rhythm Set.

START/STOP: Every press of the pedal makes the sequencer alternate between playback and stop.

PUNCH-I/O: Every press of the pedal makes the sequencer alternate between starting and stopping manual punch-in recording.

TAP-TEMPO: Tap tempo (a tempo specified by the interval at which you press the pedal).

OCT-UP: Each pedal press raises the key range in octave steps (up to 3 octaves higher).

OCT-DOWN: Each pedal press lowers the key range in octave steps (up to 3 octaves lower).

Use the Output parameter to select the sound source(s) (the internal sound source and/or external sound sources connected to MIDI OUT connector) to be controlled by the pedal.

OFF: Neither will be controlled.

INT: Only the internal sound source will be controlled.

MIDI: Only external sound sources will be controlled.

INT&MIDI: Both the internal sound source and external sound sources will be controlled.

The Polarity parameter switches the polarity of the pedals. On some pedals, the electrical signal output by a pedal when pressed or released may be in opposite polarity to the other pedals. If using this type of pedal, set this parameter to REVERSE. If you are using a Roland pedal (no polarity switch), set this parameter to STANDARD.

Control Source display

Select the type of pedal messages that will be used to control Peak&Hold (p.48).



Hold (Hold control source)

Selects the type of pedal message that will be used to hold the current parameter values.

OFF: Not used

HOLD-1: Hold 1 (controller number 64)

SOSTENUTO: Sostenuto (controller number 66)

SOFT: Soft pedal (controller number 67)

HOLD-2: Hold 2 (controller number 69)

Peak (Peak control source)

Selects the type of pedal message that will be used to hold the highest parameter values received.

OFF: Not used

HOLD-1: Hold 1 (controller number 64)

SOSTENUTO: Sostenuto (controller number 66)

SOFT: Soft pedal (controller number 67)

HOLD-2: Hold 2 (controller number 69)

Volume (Volume control source)

Specifies whether or not Expression messages (controller number 11) will affect the volume of a Patch or Part, as with Volume messages (controller number 7).

VOLUME: Only Volume messages will affect the volume, not Expression messages.

VOL&EXP: Both Volume and Expression messages will affect the volume.

Aftertouch (Aftertouch control source)

Selects the types of aftertouch messages that will affect the internal sound source.

CHANNEL: Channel aftertouch (aftertouch applied equally to all keys).

POLY: Polyphonic aftertouch (aftertouch applied independently to each key)

CH&POLY: Channel aftertouch and polyphonic aftertouch

* The XP-80's keyboard will not transmit polyphonic aftertouch messages.

Arpeggio settings (Arpeg)

Arpeggio display

This is where to set Arpeggiator parameters.



Style

Sets the style of the arpeggio. Select from the following 33 options. For creating your own style, choose LIMITLESS.

1/4: Beats with a quarter note interval.

1/6: Beats with a quarter note triplet interval.

1/8: Beats with an eighth note interval.

1/12: Beats with an eighth note triplet interval.

1/16: Beats with a sixteenth note interval.

1/32: Beats with a thirty-second note interval.

GLISSANDO: A glissando occurs in ascending and descending scales with a thirty-second note interval between the lowest and highest keys pressed.

SEQUENCE A: A sequence pattern often used in techno music.

SEQUENCE B: A sequence pattern containing small notes.

SEQUENCE C: A slightly unusual sequence pattern.

ECHO: Echo-type style.

SYNTH BASS: A typical synth bass pattern. With Octave Range set to +1, a bass pattern can be played simply by pressing a single note.

SLAP BASS A: Chopper bass style.

SLAP BASS B: Light chopper bass style.

WALK BASS: Walking bass style.

RHYTHM GTR A: Rhythm guitar style (with a single note). Clavinet Tone works well with this style.

RHYTHM GTR B: Rhythm guitar style (with a chord).

RHYTHM GTR C: A style adding a variation to a rhythm guitar.

RHYTHM GTR D: A style adding a variation to a rhythm guitar.

RHYTHM GTR E: A style adding a variation to a rhythm guitar. As the timing in which sound is produced varies between strings, more of an acoustic guitar-like sound will be heard.

3 FINGER GTR: Folk guitar's three-finger picking style.

STRUMMING GTR: A style simulating an upward or downward chord strum on a guitar. Effective when five or six notes are held.

KBD COMPING A: Piano backing style.

KBD COMPING B: Keyboard instrument backing style.

KBD COMPING C: Triplet-meter style.

KBD COMPING D: Swing waltz style.

KBD COMPING E: Reggae-type style. Effective when three notes are held.

PERCUSSION: A style suitable for percussion instrument sounds.

HARP: A style simulating harp playing.

SHAMISEN: A style simulating shamisen playing.

BOUND BALL: A style similar to a bouncing ball.

RANDOM: Keys pressed will sound an arpeggio in random order at sixteenth note intervals.

LIMITLESS: Settings for the Motif, Beat Pattern, Shuffle Rate and Accent Rate parameters can be combined in any way you like and stored.

* Choices can be set for the Motif, Beat Pattern, Shuffle Rate and Accent Rate parameters for each style. Refer to the “Arpeggio Style list” (p.213).

Motif

Sets the order in which notes of the chord will sound. Some settings will not be available depending on the Style parameter setting.

SINGLE UP: Notes will sound singly, starting from the lowest key pressed.

SINGLE DOWN: Notes will sound singly, starting from the highest key pressed.

SINGLE UP&DOWN: Notes will sound singly, starting from the lowest key pressed, going up and then back down.

SINGLE RANDOM: Notes will sound singly in random order.

DUAL UP: Notes will sound in pairs, starting from the lowest key pressed.

DUAL DOWN: Notes will sound in pairs, starting from the highest key pressed.

DUAL UP&DOWN: Notes will sound in pairs, starting from the lowest key pressed, going up and then back down.

DUAL RANDOM: Notes will sound in pairs, in random order.

NOTE ORDER: Notes will sound in the order that they were pressed. Up to 32 notes can be stored, so you can create melody lines by pressing keys in the appropriate order.

GLISSANDO: Notes will be played in an ascending and descending chromatic scale between the lowest and the highest keys that are pressed. Simply press two notes, the lowest and highest.

CHORD: All notes that are pressed will sound simultaneously.

BASS+CHORD1–5: The lowest note that is pressed and other notes will sound as a chord.

BASS+UP1–8: The lowest note that is pressed and other notes will sound as an arpeggio.

BASS+RANDOM1–3: The lowest note that is pressed and other notes will sound randomly.

TOP+UP1–6: The highest note that is pressed and other notes will sound as an arpeggio.

BASS+UP+TOP: Simulated fingering of folk guitar’s three-finger picking technique.

Beat Pattern

Select the beat pattern from the choices below. This setting will affect the location of the accent and length of the notes to determine the beat (rhythm).

Some settings will not be available depending on the Style parameter setting.

- 1/4
- 1/6
- 1/8
- 1/12
- 1/16 1–3
- 1/32 1–3
- SEQ-A 1–7
- SEQ-B 1–4
- SEQ-C 1–2
- ECHO1–3
- MUTE01–16
- STRUM1–8
- REGGAE
- REFRAIN1–2
- PERC1–4
- WALKBS
- HARP
- BOUND
- RANDOM

Accent Rate

Modifies the strength of accents and the length of the notes to adjust the ‘groove’ feel of the arpeggio. A setting of 100% will produce the most pronounced groove feel.

Shuffle Rate

This parameter allows you to modify the timing of an up-beat between two down-notes next to each other, to create shuffle rhythms. With a setting of 50%, the notes will be spaced evenly. Higher values will give more of a ‘dotted’ (shuffle) feel.

Octave Range

Sets the key range in octaves over which arpeggio will take place. If you want the arpeggio to sound using only the notes that you actually play, set this parameter to 0. To have the arpeggio sound using the notes you play and notes 1 octave higher, set this parameter to +1. A setting of -1 will make the arpeggio sound using the notes you play and notes 1 octave lower.

Key Velocity

Sets the force of the chord. If you wish to use the velocity at which the notes are actually played, set this parameter to REAL. To use a constant velocity regardless of the force with which you play the keyboard, choose a desired value from 1–127.

Part (Arpeggio part)

When using a Layer performance, you can use this parameter to specify the Part for playing an arpeggio. Parts other than that you specify will sound as you play on the keyboard.

- * This setting will be invalid if Single performance, Patch mode or Rhythm Set mode is selected.

Tempo(=SEQ)

Sets the speed of the arpeggio. This setting is the same as the tempo of the song. Changing this setting will also affect the song's playback tempo.

Arpeggio Window

Specifies whether you want or don't want the Arpeggio window to open when the Play display of a sound source mode is up. Specify ENABLE if you want the Arpeggio window to open each time [ARPEGGIO] is pressed. If not, set this parameter to DISABLE.

- * If you have selected ENABLE for the Arpeggio Window parameter and close the Arpeggio window by pressing [F6] (Close) or [EXIT], [F6] (Arpeg) on the Play display of a sound source mode will re-open the Arpeggio window. If you want to use the button's original function in each Play display, hold down [SHIFT] while you press [F6].

Confirming the XP-80's current conditions (Info)

On this display you can confirm the Wave Expansion Boards installed as well as XP-80 battery status.

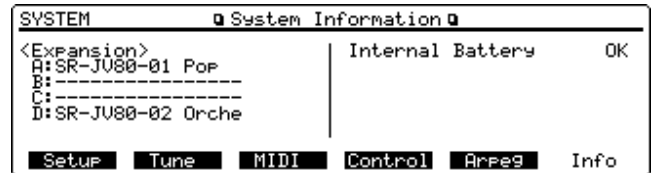
System Information display**<Expansion>A–D (Information expansion boards)**

The names of Wave Expansion Boards installed in slots A–D are displayed. Slots without any boards installed are indicated “---.”

Internal Battery (Internal battery check)

The XP-80 incorporates batteries to preserve data. Internal Battery checks battery voltage. An “OK” indication means optimal performance, while a “LOW” indication means lowered battery voltage. This would be a good time to ask your nearest Roland Service Center for a battery replacement.

Chapter 4. Playing back and recording a song

About the sequencer

A sequencer records keyboard performance and controller movements as MIDI messages (sequencer data). As the data plays back, the recorded MIDI messages are sent to a sound source which will produce the required sounds. The sequencer actually plays instruments instead of the musician, and since it can record a musical performance, it is a tape recorder as well. But in reality a sequencer doesn't record sound, but actually the steps that cause the sound source to produce sound, so it offers several advantages. Sound quality is always excellent, the equivalent of first-generation tape, no matter how many times the data plays back; tempo changes have no effect on pitch; detailed editing is possible, etc.

Songs

For the XP-80, musical performance data for one song or composition is referred to as a 'song.' A song combines sequencer data recorded on Phrase tracks 1–16, a Tempo track, a Beat track and a Pattern track, as discussed below.

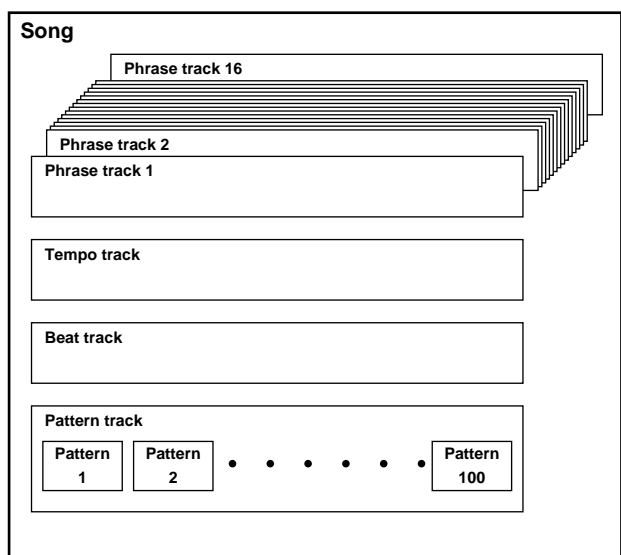

Track configuration

Each section of a song which stores musical performance data is called a 'track.'

Phrase tracks 1–16

Phrase tracks record the musical performance of an instrument. There are 16 Phrase tracks, and each track records data of 16 MIDI channels. Totally, up to 16 tracks×16 MIDI channels of data can be recorded.

Tempo track

The Tempo track records tempo changes of a song over time. It can be used for tempo changes during a song. If a song has the same tempo from beginning to end, the Tempo track can be ignored.

When a song is first recorded on the XP-80, a tempo setting at the time of recording will be stored at the beginning of the Tempo track. Therefore when song playback starts from the beginning, the song will always play back at this initial tempo.

Thus playback tempo is determined by the Tempo track setting. If you modify the tempo during playback, the overall tempo of the song will be controlled by the setting you make.

Beat track

The Beat track records the time signature of each measure of a song. Set the Beat track when recording a new song, or when you want to change time signature during a song.

Pattern track

You can also use the Pattern track to record musical passages, separately from the Phrase tracks. Musical data in the Pattern track is regarded as separate Patterns. Up to 100 Patterns can be created, and each Pattern can contain data for 16 MIDI channels, as with Phrase tracks.

Pattern Call messages (messages commanding specified Patterns to play back) can also be recorded on a Phrase track and a song created by combining several Patterns.

Positions for storing a song

Internal memory

The sequencer has an area called 'internal memory' that can temporarily store one song. So we call this temporary song 'Internal Song'.

To play back a song saved to a disk with the XP-80, it doesn't have to be loaded into internal memory. Only when you're going to record a song or edit a song saved to disk, do you have to load it into internal memory. Since only one song can be worked on during recording or editing, all the internal memory has to do is store one song (about 60,000 notes).

The song in internal memory is volatile and will be lost when the power is turned off. To keep a song, you must save it to disk.

Disk

When keeping a recorded or edited song in internal memory, save it to disk as a song file. Up to 99 songs can be saved to a single disk.

A disk can contain five file types. The three-letter symbol shown in parentheses () is a file name extension that distinguishes the different file types.

Song file (.SVQ)

This file is a song created on the XP-80. It is called an 'MRC Pro song.' Other MRC Pro songs include those created on the XP-50.

Standard MIDI File (.MID)

Standard MIDI File is a standard file format that allows sequencer data to be exchanged between most musical applications. XP-80 files can be saved as Standard MIDI Files. Also, the XP-80 plays back commercial GM System compatible Standard MIDI File releases.

Chain file (.SVC)

This file contains Chain Play settings.

User groove template file (.SVT)

This file contains user groove templates which are the basics for groove quantize.

Data file (.SVD)

This file contains Sound Source and System settings.

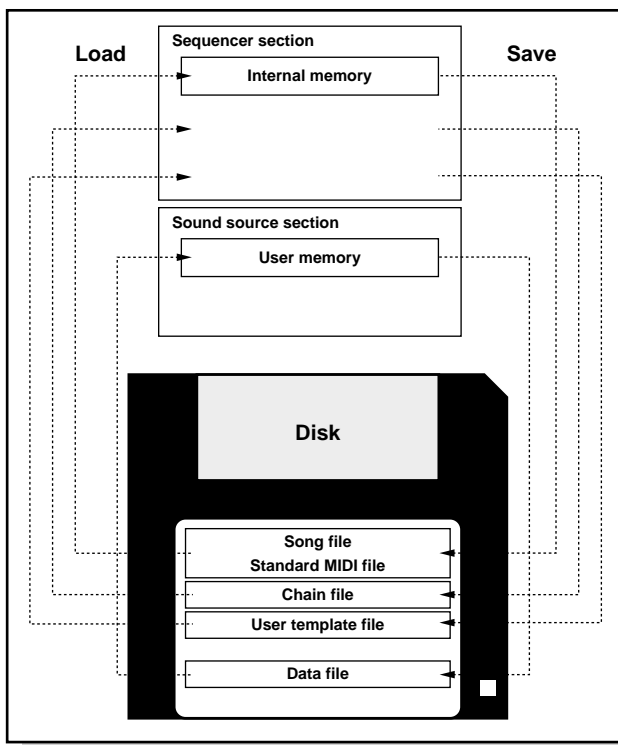

Playing back a song

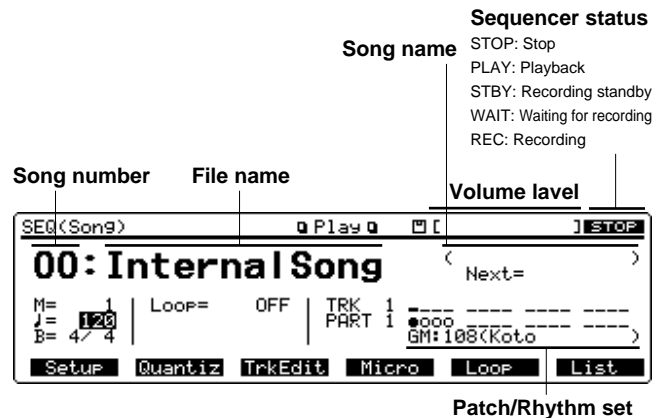

Volume label

When a disk is in the disk drive, "☐" is displayed. If the disk has a name (volume label), it will be displayed in square brackets [].

Song number

The song number corresponds to the alphabetic order of the file names for the MRC Pro and Standard MIDI File songs saved on a disk, starting from 01. However, the number of the song in internal memory (internal song) is 00.

File name

When a song is selected by changing the song number, its file name will be displayed. The file name is the name used to save a song to the disk.

If the internal song is selected, the display will indicate "Internal Song."

Song name

The song name represents the title of the currently selected song. If the selected song does not have a name, nothing will be displayed.

Next (Programmed song)

Up to three songs can be programmed for successive playback while the current song is playing.

M (Measure)

Shows the current measure number of a song.

J (Playback tempo)

Displays the tempo a song plays back in (playback tempo). If you change the tempo here, the overall tempo of the song will change accordingly.

B (Beat)

Shows the time signature of a song.

Loop

Specifies playback to repeat over a section of a song you specify (p.102).

TRK (Phrase tracks)

Shows the status of Phrase tracks.

Phrase tracks with sequencer data recorded are displayed with “o,” and those not containing sequencer data with “-.” The Phrase tracks that contain sequencer data but that are not to be played back are displayed in grey.

PART

This information appears when Performance mode is selected. The Part that will be played from the keyboard (current Part) is displayed with “o,” and those Parts not to be played with “_.” If a Layer Performance is selected, Parts with the Local Switch parameter (PERFORM/MIDI/Part MIDI) set ON are indicated with “o,” and all such Parts will be played from the keyboard.

If Patch mode or Rhythm Set mode is selected, “Patch Mode” or “Rhythm Mode” will appear instead.

Patch/Rhythm Set

The name of the Patch or Rhythm Set assigned to the current Part will be displayed in parentheses (). When changing the Patch or Rhythm Set, set new group and number. This also applies when Patch mode or Rhythm Set mode is selected.

Playing back a song directly from disk (Quick Play)

The XP-80 will play back songs from disk directly without first loading them into internal memory. This is the Quick Play function.

The Quick Play function can be used for MRC Pro songs (extension: .SVQ) and Standard MIDI Files (extension: .MID).

<Procedure>

- ❶ Insert the disk with the song into the disk drive.
- ❷ Press [SEQUENCER] to call up the Play display (SEQ(Song)).
- * If the Play display (SEQ(Pattern)) appears, press [SEQUENCER] again or press [EXIT] or [PATTERN].
- ❸ Move the cursor to the song number and select the number of the song you wish to play back.

The number and name of the selected song will be boxed, which indicates song selection has yet to be finalized.

- ❹ Press [ENTER] to finalize the song.

The box around the song number and song name will disappear to show that the song selection has been finalized.

- ❺ Press [STOP/PLAY] to begin playback.

When the song ends, playback will stop automatically. To interrupt playback, press [STOP/PLAY].

- * There may be a slight delay before playback starts – if setup data is included at the song’s beginning or if the song uses the RPS function.
- * If you have interrupted song playback, “+” may be displayed at the right of the measure number. This indicates that the song is stopped in mid measure.
- * If you press [STOP/PLAY] instead of [ENTER] in step 4 above, playback will begin immediately.

<Displaying a song list>

To view the list of songs that can be quick played, you open the Song List window. Up to seven songs can be displayed in alphabetical order at one time. This allows you to quickly select the desired song.

<Procedure>

- ❶ Make sure that the Play display (SEQ(Song)) is up.
- ❷ Press [F6] (List) to open the Song List window.

The cursor is positioned at the song currently selected.

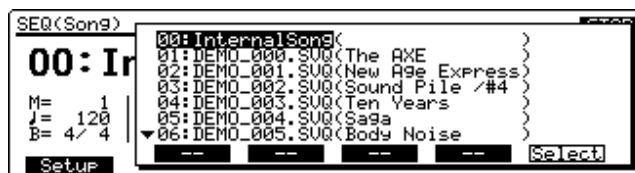

- ❸ Press [▲], [▼], [INC] or [DEC] or turn the VALUE dial to select the desired song. You can also select the song by specifying its song number with the numeric keys.

As the song entry has not yet been finalized, the song number and file name will be boxed.

- * A ▲ mark or ▼ mark appearing at the display upper left or lower left shows there are more songs which don't appear on current display page.
- * To return the cursor to the currently selected song, press [EXIT]. Pressing [EXIT] again will close the Song List window.
- ❹ Press [F6] (Select) or [ENTER] to finalize the song entry.

The song entry will be finalized and the Song List window will be closed. Pressing [STOP/PLAY] instead will begin the playback immediately.

Fast-forwarding or 'rewinding' a song

You can fast-forward or 'rewind' a song from stop as well as in playback.

Press [FWD] to fast-forward the song, and press [BWD] to 'rewind' it. To continuously fast-forward or 'rewind' the song, keep on pressing the respective button.

If you hold down [FWD] as you press [BWD], the song will fast-forward at a faster speed. Pressing [FWD] while holding down [BWD] will 'rewind' a song faster.

To instantly go to the end of the song, press [FWD] while holding down [SHIFT]. Pressing [BWD] while holding down [SHIFT] moves you right back to the beginning of the song. Executing any of these operations while the song plays back will interrupt playback.

If you move the cursor to “M” and specify the measure number with numeric keys, you will go right to the specified measure.

- * Fast-forwarding or 'rewinding' a song during quick play may take a little time.

Resuming playback from the middle of a song (MIDI Update)

When you fast-forward or 'rewind' a song to a different Song position and resume playback, sometimes the correct Patches may not have been selected, or pitch bend or other controller data has been left 'hanging.' This is because data in the intervening measures has not been sent to the internal sound source. In such cases, use the MIDI Update function. MIDI Update transmits all MIDI messages (except Note messages) in the skipped measures (from the beginning of the song to the new Song position) to the sound source, ensuring that the sound source is correctly set for playback to resume from the new Song position.

<Procedure>

- 1 Make sure that the Play display (SEQ(Song)) is up and song playback is stopped.

MIDI Update cannot be executed while a song is playing back.

- 2 While holding down [SHIFT], press [STOP/PLAY]. While processing is taking place, the display will indicate "MIDI Update..." When processing is completed, "COMPLETE" will appear.

Programming songs for playback

If you want to play back other songs in succession, you can select up to three songs while the current song is playing.

<Procedure>

- 1 Make sure that the Play display (SEQ(Song)) is up and the song is playing.

Song programming is possible only during playback.

- 2 Move the cursor to the song number, and select the song(s) you wish to program.
- 3 Press [ENTER] to finalize the selection. The programmed song numbers will appear on the display in the order you selected them.

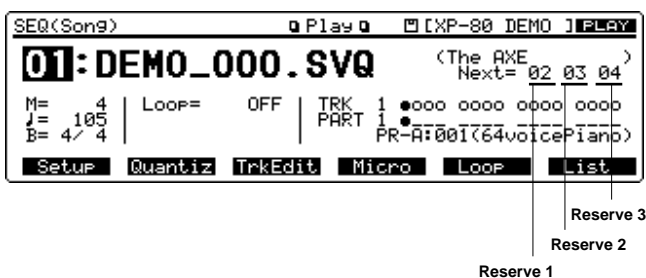

- * To cancel a song you programmed, press [EXIT]. Each time you press [EXIT], the last-programmed song will be cancelled.
- * If you press [STOP/PLAY] instead of [ENTER], the song currently playing will stop and the song you just programmed will begin playing back. At this time, the previously programmed songs will be cancelled.

Changing the Part to be played from the keyboard

When playing the keyboard along with an ensemble song playback, select the Part to be played from the keyboard. This will allow you to play bass or drums from the keyboard.

<Procedure>

- 1 Make sure that the Play display (SEQ(Song)) is up.
 - 2 Move the cursor to "PART."
- * If you move the cursor to "PART" while a song is playing back, the button indicators for TRACK/PART [1]-[16] light or remain off. Lighted indicators show that these Parts are receiving MIDI messages.
- 3 Press a TRACK/PART [1]-[16] button to select the Part to play from the keyboard.

If you change the Part by pressing TRACK/PART [1]-[16], the correspondingly numbered Phrase track will be chosen. If you want to change only the Part, turn the VALUE dial or press [INC]/[DEC].

- * If you have selected a Layer Performance, pressing a key will make all the Parts indicated with "o" sound.

Changing the instrument sounds for song playback

When playing back a song, you can change the Patch or Rhythm Set to enable song playback with any instrument sound you want.

<Procedure>

- 1 Make sure that the Play display (SEQ(Song)) is up.
 - 2 Move the cursor to "PART."
- * If Patch mode or Rhythm Set mode has been selected, "Patch Mode" or "Rhythm Set Mode" will appear instead of "PART," so steps 2 and 3 will be omitted.
- 3 Press a TRACK/PART [1]-[16] button to choose the Part to which you want to assign a new Patch or Rhythm Set.

If you select a Part using TRACK/PART [1]-[16], the correspondingly numbered Phrase track will also be selected. If you want to change only the Part, turn the VALUE dial or press [INC]/[DEC].

- 4 Press [▼] to move the cursor down and change the group and number to select the Patch or Rhythm Set you want.
- * When you've changed the Patch or Rhythm Set assigned to a Part, the setting will be lost if power is turned off or if you select another Performance. If you wish to keep this setting, you must rewrite the Performance.

Silencing specific instruments 1 (Muting Phrase tracks)

If you wish to silence specific instruments during playback, you can mute the appropriate Phrase track containing that sequencer data.

- * It is not possible to use this procedure to mute Phrase tracks when quick playing Standard MIDI Files or when the Phrase track contains sequencer data of multiple instruments (channels). Follow the procedure discussed in the “Silencing specific instruments 2” below.
- * Note that if you save a song with a Phrase track muted in the Standard MIDI File format, that Phrase track’s data will not be saved. If you save a song that has a muted Phrase track in the MRC Pro song format, the mute status of the track will also be saved.

<Procedure>

- 1 Make sure that the Play display (SEQ(Song)) is up.
- 2 Move the cursor to a position other than “TRK” or “PART.”
- 3 Press TRACK/PART [1]–[16] to make the button indicators of your selected Phrase track(s) to be muted go off.
- 4 To play the muted Phrase track, press the appropriate button from TRACK/PART [1]–[16] again to make its indicator light.

To play only a specific Phrase track, hold down [SHIFT] as you press the appropriate button from TRACK/PART [1]–[16] to light its indicator. Pressing TRACK/PART [1]–[16] while holding down [SHIFT] again will play all Phrase tracks.

- * The button indicator of the Phrase track containing no sequencer data is always kept off, meaning that the track cannot be played.

Silencing specific instruments 2 (Turning the Receive channel off)

If you wish to silence specific instruments during quick play of a Standard MIDI File or during playback of a song with multiple instrument (MIDI channels) sequencer data on a specific Phrase track, use the following procedure to turn off the desired Part(s).

<Procedure>

- 1 Make sure that the Play display (SEQ(Song)) is up.
- 2 Press [LOCAL/TX/RX] to open the LOCAL/TX/RX window.

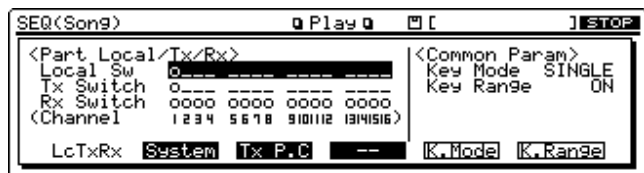

- 3 Move the cursor to “Rx Switch.”

The display will indicate the Parts to produce sound with “o.”

- 4 Press TRACK/PART [1]–[16] to make the button indicators of the Part(s) to be muted, go off.

Parts turned off (indicator off) will be indicated with “_”.

- 5 To play the muted Part, press the appropriate button again to make its indicator light.
 - 6 Press [EXIT] or [LOCAL/TX/RX] to close the window.
- * This setting can be saved as part of the Performance settings.

Playing back a song with a tempo change

When playing back a song, the XP-80’s sequencer follows the tempo recorded on the Tempo track, but you can also change the entire song’s tempo during playback. The tempo you actually use to play back a song is called ‘playback tempo.’ To change the play tempo, you can either use buttons or the Tap Tempo function that sets the tempo to the interval at which you press the control pedal.

- * Playback tempo is only a temporary setting, so if you change the song or turn the power off, the setting will be lost. If you also want to play the song again at the same play tempo, save the song to the disk again.
- * Playback tempo can be modified over the range from 1/2 to twice the tempo changes recorded on the Tempo track.
- * If after modifying playback tempo you want to restore the tempo changes recorded on the Tempo track, hold down [SHIFT] and press [TEMPO/BEAT].

Changing the tempo using buttons

<Procedure>

- 1 Make sure that the Play display (SEQ(Song)) is up.
- 2 Move the cursor to “♩.”
- 3 Turn the VALUE dial, press [INC]/[DEC] or numeric keys to change tempo.

Changing the tempo using the Tap Tempo function

- 1 Make sure that the Play display (SEQ(Song)) is up.
- 2 Connect an optional pedal switch to any of CONTROL PEDAL 1–4 jacks.
- 3 Press [SYSTEM].
- 4 Continue pressing [F4] (Control) until the Pedal Assign display will appear.

Each time [F4] (Control) is pressed, the display will cycle through the Control Assign display, Pedal Assign display, Control Source display and then back to the Control Assign display, and so on.

- 5 Move the cursor to <Assign> of the CONTROL PEDAL jack to which a pedal switch is connected, and choose “102:TAP-TEMPO.”
- 6 Press [EXIT] to return to the Play display (SEQ(Song)).
- 7 Press the pedal at the tempo you want to play the song. Pressing the pedal three or more times at regular intervals will set the tempo to the interval at which you press the pedal.

Playing back a song with a constant tempo (Muting the Tempo track)

If the song changes tempo during playback, these tempo changes are recorded on the Tempo track. If you want to play back the song at a constant tempo (without tempo changes), you can mute the Tempo track.

<Procedure>

- 1 Make sure that the Play display (SEQ(Song)) is up and the song is stopped.

You cannot mute the Tempo track while a song is playing back.

- 2 Move the cursor to a position other than "TRK."
- 3 Press [TEMPO/BEAT] to make the button indicator go off.

To cancel the muting, press [TEMPO/BEAT] again to make the indicator light.

Playing back a Pattern

Aside from the Phrase tracks, songs also contain a Pattern track. Patterns are a unit of musical data which can be handled and played back separately from Phrase tracks. However, it is not possible to quick play a Pattern. To play back a Pattern, the song containing the Pattern must be loaded into internal memory.

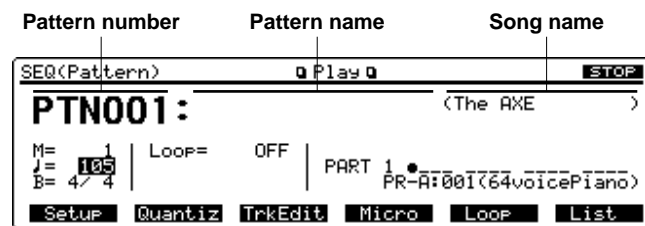

Pattern number

Shows the number (001–100) of each Pattern recorded on the Pattern track.

Pattern name

If you select a Pattern by changing the Pattern number, that Pattern's name will be displayed. Nothing will appear if a name is not assigned to the Pattern.

Song name

Shows the name of the selected song.

M (Measure number)

Shows the current measure number of the Pattern.

J (Playback tempo)

Shows the playback tempo of a song.

- * As Patterns have no Tempo track for tempo management, it is impossible to set an independent tempo for each Pattern.

B (Beat)

Shows the time signature of the Pattern (Pattern beat).

Loop

Specifies repeated playback over the section of a song you specify (p.102).

- * Each song can have only one Loop setting; it is not possible to specify a Loop setting for each Pattern.

PART

If Performance mode is selected, the display will show the Part to be played from the keyboard (current Part) with "o," and those not to be played with "_". If a Layer Performance is selected, however, Parts with the Local Switch parameter (PERFORM/MIDI/Part MIDI) set ON will be indicated with "o," meaning that all such Parts will be played from the keyboard.

If you are in Patch mode or Rhythm Set mode, "Patch Mode" or "Rhythm Mode" will respectively appear instead.

- * Each song can have only one Part setting; a separate Part setting for each Pattern cannot be specified.

Patch/Rhythm Set

The name of the Patch or Rhythm Set assigned to the current Part will appear in parentheses (). To change the Patch or Rhythm Set, modify the group and number. Do the same when you are in Patch mode or Rhythm Set mode.

- * Each song can have only one Patch/Rhythm Set setting; a separate Patch/Rhythm Set setting for each Pattern cannot be specified.

<Procedure>

- 1 Insert the disk into the disk drive.
- 2 Press [DISK].
- 3 Press the numeric key [1], then [ENTER].
- 4 Move the cursor to "File Type" and choose SONG.
- 5 Move the cursor to "File Name" and select the song you want to load.
- 6 Press [F6] (Execute).

The song has been loaded into the internal memory. The Play (SEQ(Song)) will appear.

- 7 Press [PATTERN] to call up the Play display (SEQ(Pattern)).
- 8 Move the cursor to the Pattern number and select the Pattern you want to play back.
- 9 Press [STOP/PLAY] to play back the Pattern.

When the song finishes, playback will stop automatically. To interrupt Pattern playback, press [STOP/PLAY].

- * It is possible to change the playback tempo or mute the Tempo track during the Pattern playback. However, this tempo change is part of the song's setting, not the Pattern's.

- 10 When you finish playing back the Pattern, press [PATTERN], [EXIT] or [SEQUENCER] to return to the Play display (SEQ(Song)).

Playing back a song created in the S-MRC format

The XP-80 can play back S-MRC format songs created on the Roland MC-50 or other sequencers as well as MRC Pro songs or Standard MIDI Files. It is, however, not possible to quick play an S-MRC format song. To play it back, you have to load it into the internal memory first and convert it to the MRC Pro format.

<Procedure>

- ❶ Insert the disk into the disk drive.
- ❷ Press [DISK].
- ❸ Press the numeric key [1], then [ENTER].
- ❹ Move the cursor to "File Type" and choose "S-MRC."
- ❺ Move the cursor to "File Name" and select the song you want to load.
- ❻ Press [F6] (Execute).

The song has been loaded into the internal memory. The Play (SEQ(Song)) will appear.

- ❼ Press [STOP/PLAY] to play back the song.

When the song finishes, playback stops automatically. To interrupt playback, press [STOP/PLAY].

Repeatedly playing back a song (Loop Play)

You can repeatedly play back the entire song or a specified area using the Loop function.

<Procedure>

- ❶ Make sure that the Play display (SEQ(Song)) is up.
- ❷ Press [LOOP] to make the indicator light.

Now you're ready for loop play.

- ❸ Move the cursor to "Loop" and specify the loop area.

OFF: Loop play will not be used. [LOOP] indicator will go off.

POINT: Playback over the area specified by the Loop points will repeat the specified number of times. The loop area will be displayed in parentheses ().

1: Loop play will occur from the beginning of the current measure over one measure, the specified number of times.

2: Loop play will take place from the beginning of the current measure over two measures, the specified number of times.

4: Loop play will take place from the beginning of the current measure over four measures, the specified number of times.

8: Loop play will take place from the beginning of the current measure over eight measures, the specified number of times.

16: Loop play will take place from the beginning of the current measure over 16 measures, the specified number of times.

ALL: The entire song will play back the specified number of times.

- * If you have selected a song saved on disk, you can choose either OFF or POINT only. Pressing [LOOP] will toggle between OFF and POINT. To select another value, load the song into internal memory.

- * Set the Loop points and playback repeat number in the Loop window that can be opened by pressing [F5] (Loop) (p.120). If you have selected a song saved on disk, a window asks "This Song is not Internal Song. Load anyway?" If you want to erase the song from the internal memory and load the new song, press [F5] (OK). If you decide not to erase the song from the internal memory, press [F6] (Cancel).

- ❹ Press [STOP/PLAY] to begin playback.

When the song finishes, playback will automatically stop. To interrupt playback, press [STOP/PLAY].

- * You can cancel loop play by pressing [LOOP] while the song is loop playing. Other settings, however, cannot be modified.

- * If you save the song as an MRC Pro song when [LOOP] is on, this setting will be stored as part of the song data. Therefore, each time the song is played back, it will loop play.

Changing sound character during playback

If you want to add attack to the sound or adjust its decay during playback, use the Sound Palette.

- ❶ Make sure that the Play display (SEQ(Song)) is up.
- ❷ Move the cursor to "PART" and press TRACK/PART [1]-[16] to choose the Part you want to modify.

If you are using a Single Performance, only the sound character of the current Part will vary. If you've selected a Layer Performance, the sound character of the Parts with the Local Switch parameter (PERFORM/MIDI/Part MIDI) set ON will vary.

- * If you've selected Patch mode, "Patch Mode" will appear instead of "Part," so step 2 will be omitted.

- ❸ Raise the sliders to appropriate positions.
- ❹ Press [FILTER/ENV] to make the indicator light.
- ❺ Move the sliders to change the sound character as desired.

To modify the brightness, move the CUTOFF slider.

To change the resonance, move the RESO. slider.

To apply attack to the sound, move the ATTACK slider.

To change the decay time, move the DECAY slider.

Adjusting volume balance between Parts

Use the four sliders in the Sound Palette to adjust the volume level of each Part.

<Procedure>

- ❶ Make sure that the Play display (SEQ(Song)) is up.
- ❷ Move the cursor to “PART” and press TRACK/PART [1]–[16] to choose the Part whose volume level you want to change.

If you’ve selected any of Parts 1–4, sliders 1, 2, 3, and 4 adjust Parts 1, 2, 3, and 4, respectively.

If you’ve selected any of Parts 5–8, sliders 1, 2, 3, and 4 adjust Parts 5, 6, 7, and 8, respectively.

If you’ve selected any of Parts 9–12, sliders 1, 2, 3, and 4 adjust Parts 9, 10, 11, and 12, respectively.

If you’ve selected any of Parts 13–16, sliders 1, 2, 3, and 4 adjust Parts 13, 14, 15, and 16, respectively.

- * You can similarly adjust volume balance between Tones in Patch mode. In this case, “Patch Mode” will be displayed instead of “PART,” so step 2 will be omitted. Use sliders 1, 2, 3, and 4 to adjust the volume level of Tones 1, 2, 3, and 4, respectively.
- ❸ To have the song fade in, set the sliders to their lowest settings. To fade out, put the sliders to their max settings. For other cases, set sliders to the appropriate settings.
- ❹ Press [LEVEL] to make the indicator light.
- ❺ Move the sliders to adjust the volume level of each Part as desired.

Adjusting panning of each Part

You can use the four sliders in the Sound Palette to adjust each Part’s panning. The Sound Palette can also be used as a mixer since you can also control aftertouch and pitch bending depending on the setting.

- * When Patch mode or Rhythm Set mode is selected, this operation cannot be executed.

<Procedure>

- ❶ Make sure that the Play display (SEQ(Song)) is up.
- ❷ Raise the sliders to appropriate positions.
- ❸ Press [PERFORM] then [F6] (Info) to call up the Part Information display (PERFORM/Info).
- ❹ Press [F5] (Pan) to call up the Part Information display (PERFORM/Info) for Pan.

If the display does not show (Pan) for [F5], keep pressing [F6] (Menu) until it appears.

- * If you call up the Part Information display (PERFORM/Info) of another MIDI message you want to adjust, you’ll be able to control that MIDI message using the Sound Palette’s four sliders.
- ❺ Move the cursor to the Part whose panning you want to adjust.

You can modify the panning of the boxed four Parts using the sliders.

If you’ve selected any of Parts 1–4, sliders 1, 2, 3, and 4 adjust Parts 1, 2, 3, and 4, respectively.

If you’ve selected any of Parts 5–8, sliders 1, 2, 3, and 4

adjust Parts 5, 6, 7, and 8, respectively.

If you’ve selected any of Parts 9–12, sliders 1, 2, 3, and 4 adjust Parts 9, 10, 11, and 12, respectively.

If you’ve selected any of Parts 13–16, sliders 1, 2, 3, and 4 adjust Parts 13, 14, 15, and 16, respectively.

- ❻ Move the sliders to adjust the panning of each Part as desired while confirming it onscreen.
- * To return to the Play display (SEQ(Song)), press [SEQUENCER].

Before you start to record

This section goes over what you should understand before recording. It covers recording methods and preparations for recording.

Recording process

Before you actually begin recording, become familiar with a song's creative process.

1. Select an instrument sound (p.105).
2. Erase the song from the internal memory (p.105).
3. Set the time signature (p.105).
4. Perform realtime recording (p.106) or step recording (p.113).
5. Edit the song using Track Edit (p.121), Quantize (p.136) or Microscope Edit (p.144).
6. Save the song to disk (p.115).

How Phrase tracks, Parts and MIDI channels interact

Each Phrase track of the XP-80 sequencer can record sequencer data of up to 16 MIDI channels, or 16 different instruments. The performance of all instruments can be laid down on one Phrase track to create a song. But recording in this way raises problems later on, if you want to re-record or modify just part of the song. Generally, it's easiest to record each Part (MIDI channel) on its own Phrase track, so that Part (MIDI channel) numbers will correspond to Phrase track numbers.

On the XP-80, selecting another Phrase track by pressing TRACK/PART [1]–[16] will also choose the correspondingly numbered Part. If you select another Part by pressing TRACK/PART [1]–[16], the correspondingly numbered Phrase track will also be selected.

By using Extract function (p.131), it also allows you to reorganize the sequencer data for MIDI channels so each channel's data is placed in its own Phrase track—handy when the sequencer data for multiple MIDI channels has been stored together in one Phrase track (such as with Format 0 Standard MIDI files).

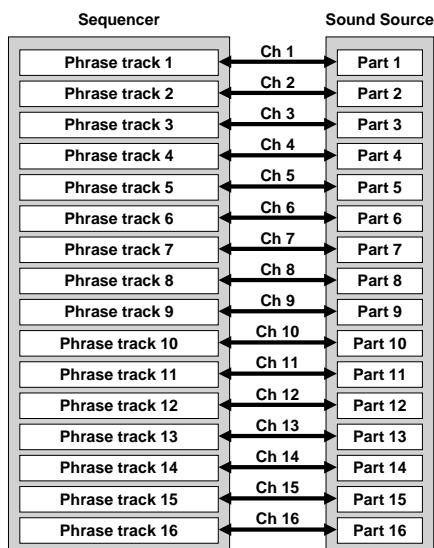

Recording methods

You can select realtime recording or step recording.

Realtime recording

With Realtime Recording, you record your keyboard performance and controller movements as they occur. Four types of realtime recording are provided to suit the situation.

Replace

If the recording destination already contains data, it will be replaced (erased and rewritten) by the most recent recorded data. Use this method for re-recording.

Mix

This is used most of the time. If the recording destination already contains data, the most recent recorded data will be added to (mixed with) the original data. The original data is not erased. This method is useful for first recording your right-hand performance, then the left-hand.

And by using this method together with loop recording, you can keep recording over a specific area without erasing the previous data, just layering instruments, handy for building up rhythm instrument group phrases.

Auto punch-in

This allows you to replace-record over only an area you've specified by Punch points. It's convenient for redoing mistakes you made when inputting data. When you start recording, the song plays back, and when the sequencer reaches the Punch point, it starts recording.

Manual punch-in

This performs replace recording only over the area you specify by pressing a pedal switch or a button. It's convenient for re-recording several areas that have data input mistakes. When you start recording, the song plays back. When you press a pedal switch or button, recording starts. Press it again to stop recording and return to playback. Each pedal press allows you to toggle between recording and playback.

Step recording

This method is for inputting notes and rests one step at a time. It's optimized for note input with precise timing, such as when you enter percussion or bass parts. If you like, you can create a song by combining Patterns besides notes.

Recording destinations of sequencer data

Sequencer data is recorded either on Phrase tracks 1–16 or in Patterns 1–100. Select the recording destination depending on the application.

Phrase tracks 1–16

You'll normally record sequencer data on Phrase tracks. It's helpful if you've made decision prior to recording such as recording melody on Phrase track 1, bass on Phrase track 2, drums on Phrase track 10, and accompaniment on the remaining Phrase tracks.

Patterns

In the same way as Phrase tracks, you can also record sequencer data in Patterns. Patterns are handled separately to Phrase tracks, but specific Patterns can be assigned for playback by a Phrase track. In cases such as percussion or bass where identical phrases are repeated frequently in one song, it's convenient to repeatedly assign the appropriate Pattern to a Phrase track using step recording. In this case, the Phrase track contains only the Pattern Call numbers that refer to the desired Pattern, and not the actual Pattern data. Therefore the same Pattern can be used any number of times with a negligible increase in memory used.

The RPS function for immediate playback also applies to Patterns. Patterns are therefore convenient for live performance, if you've recorded necessary sequencer data as Patterns and take them to the gig.

Patterns also make fine scratch-pads for musical ideas.

Selecting instrument sounds

Before you record a song, you should select the Performance, Patch or Rhythm Set you wish to use for recording.

When recording an ensemble song that will use two or more Patches, select a Single Performance. Select a Layer Performance, if you want to record a layered performance that combines different Patches for thicker and richer textures or playing a split keyboard that plays separate Patches in different keyboard areas.

Select a Patch if you want to use only one instrument.

Select a Rhythm Set if you want to use only percussion instruments.

- * If you use a Layer Performance while recording, the recorded data will contain all data necessary to play the Parts that are sounding. If each Part is receiving a different MIDI channel, the recording will contain parallel streams of data that differ only in their MIDI channels. This wastes valuable memory. To avoid this, select the same Channel parameter (PERFORM/MIDI/Part MIDI) for all Parts that are to be played simultaneously from the keyboard.
- * You can also select a Patch on the Realtime Rec Standby display (SEQ). In this case, the Bank Select number and Program number of the Patch will be recorded at the recording start position.

Erasing the song from internal memory

When you record a song, the data is stored in internal memory. If internal memory already contains a song when you wish to record a new song, that song has to be erased to free up internal memory with this procedure.

- * If internal memory contains a song you wish to keep, you must save that song to disk.

<Procedure>

- 1 Press [UTILITY].
- 2 Press the numeric key [6], then [ENTER].
- 3 Press [F6] (Execute) to erase the song from internal memory.

Setting the time signature

When recording a new song, input the time signature into the beginning of the Beat track. However, whenever power is turned on or the internal memory is initialized, the time signature will always go to its default setting of 4/4. If you want to record a song in 4/4 time, you don't have to deal with the time signature.

- * When changing time signatures in mid-song, refer to "Changing the time signature during a song" (p.148).
- * If the Pattern time is at a different setting from the song time signature when recording in Patterns, or if the song is set to a time signature other than 4/4 time, you need to set the Pattern beat for time management at the beginning of each Pattern (p.147). During recording, the metronome will sound according to the Pattern beat.

<Procedure>

- 1 Make sure that "00:InternalSong" is selected on the Play display (SEQ(Song)).
- 2 Press [F4] (Micro).
- 3 Press [TEMPO/BEAT] to select the Beat track.

Each time this button is pressed, the selection will cycle through the Tempo track, Beat track, and Phrase track, then back to the Tempo track, and so on.



- 4 Move the cursor to "Beat" and set the time signature.
- 5 Press [TEMPO/BEAT] again to return to the Phrase track.
- 6 Press [EXIT] to return to the Play display (SEQ(Song)).

Recording as you play (Realtime recording)

Realtime recording lets you record your keyboard performance and the controller movements you make as you perform them. This method retains your playing nuances.

Settings for realtime recording

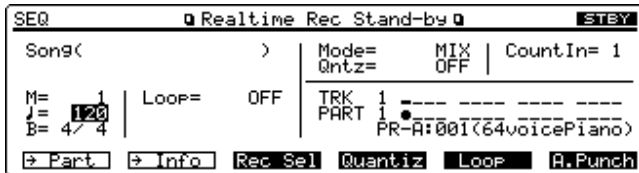

Song/Pattern (Song name/Pattern name)

When recording a song on a Phrase track, the song name will be displayed.

When recording data in a Pattern, the Pattern number and name will be displayed. When selecting a Pattern, change the Pattern number here.

M (Measure)

Displays the current Song position of a song. Set the measure to start recording here.

J (Tempo)

Sets the tempo. The tempo specified here will be recorded at the beginning of the Tempo track.

B (Beat)

Displays the time signature. When setting time signature, refer to p.105.

Loop (Loop mode)

Specifies whether you want to use loop recording.

With settings besides OFF, the [LOOP] indicator lights to show that you're ready for loop recording.

OFF: Loop recording will not be used.

POINT: Loop recording will take place in the area specified by the Loop points. Loop area will be indicated in parentheses ().

FOR 1: Loop recording will occur from the specified start recording measure to over one measure.

FOR 2: Loop recording will take place from the specified start recording measure to over two measures.

FOR 4: Loop recording will occur from the specified start recording measure to over four measures.

FOR 8: Loop recording will take place from the specified start recording measure to over eight measures.

FOR 16: Loop recording will occur from the specified start recording measure to over 16 measures.

ALL: Loop recording will take place from the beginning to the end of a song.

* Set the Loop points in the Loop window (p. 120) that opens when [F5] (Loop) is pressed.

Mode (Recording mode)

Selects how recording will take place.

REPLACE: Replace recording will be performed.

MIX: Mix recording will be performed.

A.PUNCH: Auto punch-in recording will be performed.

M.PUNCH: Manual punch-in recording will be performed.

* The Mode parameter setting will be retained until it is reset next time.

Qntz (Recording quantize)

Displays whether Quantize will/will not be applied when recording.

The Quantize function aligns notes played from the keyboard to the nearest timing interval of a specified resolution (step). Recording Quantize has two types. For recording parts such as drums or bass that require each note to be precisely on the desired beat, use Grid Quantize. For more of a shuffle or swing feel to your performance, use Shuffle Quantize.

OFF: Quantize will not be applied to recording.

GRID: Grid Quantize will be applied to recording.

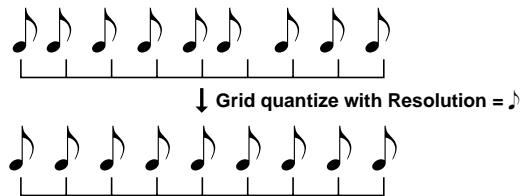

SHUFFLE: Shuffle Quantize will be applied to recording.

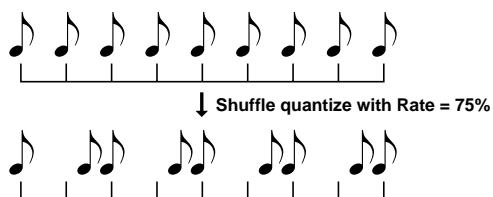

.....
<Settings for Recording Quantize>

When you use quantization at recording, set parameters in the Recording Quantize window. To open the Recording Quantize window, press [F4] (Quantize).

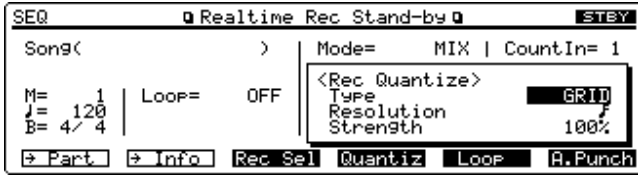

* Recording Quantize setting will be retained until it is reset next time.

Type (Quantize type)

OFF: Quantization will not be applied to recording.

GRID: Grid quantization will be applied to recording.

SHUFFLE: Shuffle quantization will be applied to recording.

Resolution

Specifies quantization time interval as a note value.

For Grid Quantize available choices are ♩, ♪, ♪₃, ♫, ♫₃, ♫₄, ♫₃, and ♫₄.

For Shuffle Quantize you can choose either ♪ or ♫.

Strength (Grid quantize strength)

This parameter is used when Grid Quantize is selected. It specifies how much the notes will move (correct) toward the timing intervals specified by the Resolution parameter. If you want notes to be move all the way to the nearest unit of the specified Resolution for maximum quantization, set Strength to 100%. As this value lowers, notes will move (correct) less from their original timing. With a setting of 0%, the note locations will not change at all.

Rate (Shuffle quantize rate)

This parameter is used when Shuffle Quantize is selected. It specifies how far a down-beat specified by the Resolution parameter will be separated from the following up-beat. With a setting of 50%, the timing of the up-beat note will be at the exact mid point between the down-beat and the following down-beat. With a setting of 0%, the up-beat note will move to the same timing as the previous down-beat. With a setting of 100%, it will move to the same timing as the following down-beat.

Count In

Specifies the way in which recording will begin.

0: Recording will begin immediately when you press [STOP/PLAY].

1: When you press [STOP/PLAY], a 1-measure count (play-back) will be included just before recording start position, and recording will commence when the start position is reached.

2: When you press [STOP/PLAY], a 2-measure count (play-back) will be included before recording start position, and recording will commence when the start position is reached.

Wait Note: Recording will begin when you play a note or press the Hold pedal.

TRK (Recording track)

Selects the recording destination Phrase track or Pattern. The cursor will move to the selected recording destination Phrase track.

Phrase tracks containing sequencer data will be marked with “o” on the display and Phrase tracks without sequencer data with “-.” Phrase tracks that contain sequencer data but are not to play back will be displayed in grey.

When recording Patterns, nothing will be displayed here.

PART

Selects the Part to use for recording.

When recording a Part with the number corresponding to the Phrase track’s, selecting a Phrase track will also select the correspondingly numbered Part. There is no need to select a Part here.

Use this parameter when you want to record using a Part with a number different from the Phrase track’s or recording your performance in a Pattern.

* If you’ve selected Patch mode or Rhythm Set mode, “Patch Mode” or “Rhythm Set Mode” will be displayed instead of “PART.”

* If a Layer Performance has been selected, Parts indicated with “o” (Local Switch parameter set ON) will be recorded as you press the key.

Patch/Rhythm Set

The name of the Patch or Rhythm Set assigned to the current Part will be displayed in parentheses (). To change the Patch or Rhythm Set, modify the group and number. This process also applies for recording in Patch mode or Rhythm Set mode.

Performing realtime recording

When you have completed preparatory steps correctly, it's time to realtime record.

<Procedure>

- ❶ Make sure that the Play display (SEQ(Song)) is up.
- ❷ Move the cursor to the song number and select the song you wish to record.

When recording a new song, select "00:InternalSong." When recording over a song saved on the disk, choose the number of that song.

- ❸ Press [REC] to call up the Realtime Rec Stand-by display (SEQ).

The [REC] indicator will blink and the metronome will start sounding.

- * If you have selected a song saved on disk, a window will ask "This Song is not Internal Song. Load anyway?" If you want to erase the song from the internal memory and load the new song, press [F5] (OK). If you decide not to erase the song from the internal memory, press [F6] (Cancel).
- * To turn off the metronome, set the Mode parameter (SEQ/Setup/SEQ System Setup) OFF.
- * To interrupt recording, press [REC] or [EXIT] to return to the Play display (SEQ(Song)).
- ❹ Move the cursor to "M" and set the recording start measure.
- ❺ Move the cursor to "♩" and set the tempo.
- ❻ If you want to use loop recording, move the cursor to "Loop" and make settings for the loop recording. If not, set it OFF.
- ❼ Move the cursor to "Mode" and select the recording mode.
- ❽ Move the cursor to "Qntz" and select quantization type. If you don't want to quantize when recording, set it OFF.

When applying quantization to recording, press [F4] (Quantize) to open the Recording Quantize window and make Quantize settings. After you have completed your settings, press [EXIT] or [F4] (Quantize) to close the Recording Quantize window.

- ❾ Move the cursor to "Count In" and specify the recording start method.
- ❿ Select the recording destination. When recording on a Phrase track, use TRACK/PART [1]-[16]. When recording in a Pattern, press [PATTERN] and specify the Pattern number.

The button indicator of the selected recording destination Phrase track or Pattern will blink. The button indicators of the Phrase tracks containing sequencer data stay lighted.

- ⓫ If you wish to record using a Part of a number different from the Phrase track's, or recording in a Pattern, select the Part used for recording. Move the cursor to "PART," and either turn the VALUE dial or press [INC]/[DEC] to choose the Part.
- * When the cursor is at "PART," pressing TRACK/PART [1]-[16] will also select the correspondingly numbered Phrase track.
- ⓬ When changing the Patch or Rhythm Set, move the cursor to the group or number and select a different

Patch/Rhythm Set.

If you want to change the Performance, press [PERFORM] to call up the Play display (PERFORM) and select another Performance. To return to the Realtime Rec Stand-by display (SEQ), press [SEQUENCER].

- * If you select another Patch, Rhythm Set or Performance on the Realtime Rec Stand-by display (SEQ), the Bank Select number and Program number of that Patch/Rhythm Set/Performance will automatically be recorded at the recording start position. However, if the Performance Ctrl-Ch parameter (SYSTEM/MIDI Param) has the same setting as the MIDI channel of the specified Part (when the Patch assigned to a Part of a Performance has been selected), be aware that this will actually select a different Performance.
- ⓭ Begin recording using the recording method selected by "Count In." When recording begins, the [REC] indicator will light. The BEAT indicator will also blink in red for the first beat and in green for other beats.
- * When recording begins, the Phrase tracks with lighted indicators will play back. If you don't want some Phrase tracks to play back during recording, move the cursor to a position other than "TRK" or "PART," and press TRACK/PART [1]-[16] to turn off the indicators of unwanted Phrase tracks.
- ⓮ When you finish recording, press [STOP/PLAY].

<Preparations for auto punch-in recording>

You can specify Punch points (area auto punch-in recording is to take place) if you're going to use this function.

<Procedure>

- ❶ Make sure that the Mode parameter is set to A.PUNCH on the Realtime Rec Stand-by display (SEQ).
- ❷ Press [F6] (A.Punch) to open the Punch Point window.

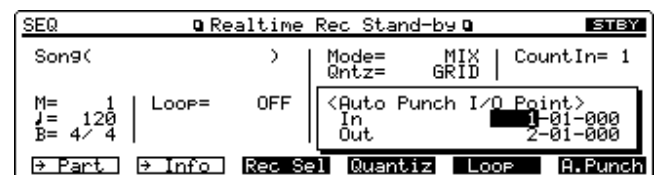

- ❸ Move the cursor to "In" and set the recording start position.

When you are using a Locate position to specify recording start position, press [LOCATE] to light the indicator and specify the Locate position number.

- ❹ Move the cursor to "Out" and set the recording end position.

If you are setting the recording start position using a Locate position, set the Locate position number for the recording end position in the same way.

- * The recording end position that is set for "Out" will not be included in the recording area.
- * A recording area setting of less than one beat is invalid.
- ❺ After you complete settings, press [EXIT] or [F6] (A.Punch) to close the Punch Point window.

<Manual punch-in recording method>

For manual punch-in recording, set the recording area by pressing a pedal switch or button.

- * To specify the recording area via a pedal switch, connect an optional pedal switch to any of CONTROL PEDAL jacks 1-4, then call up the Pedal Assign display (SYSTEM/Control) and set <Assign> of the CONTROL PEDAL jack (to which a pedal switch is connected) to "101:PUNCH-I/O."

<Procedure>

- 1 Make sure that the Mode parameter is set to M.PUNCH on the Realtime Rec Stand-by display (SEQ).
- 2 Begin recording using the recording method selected by "Count In."

The display upper right will show "WAIT" indicating that the sequencer is now in recording standby mode.

- 3 Press [F6] (PunchIn) or the pedal switch at the Song position you want to start recording.

"■" will appear next to PunchIn, showing that the song is now being recorded.

- 4 At your desired end recording Song position, press [F6] (PunchIn) or the pedal switch again.

"■" will disappear, showing the sequencer is back in its recording standby mode.

- 5 Repeat steps 3 and 4 to continue recording.

Recording specific data only (Recording Select)

Usually for realtime recording, all the sequencer data (MIDI messages) will be recorded. If you don't want to record specific sequencer data, set its Recording Select OFF.

- * Recording select setting will be retained until it is reset next time.

<Procedure>

- 1 Make sure that the Realtime Rec Stand-by display (SEQ) is up.
- 2 Press [F3] (Rec Sel) to open the Recording Select window.



- 3 Specify whether you want to record each of the following sequencer data or not. When recording, set ON and if not, set OFF.

Channel (MIDI channel): When recording the sequencer data of all MIDI channels, set this parameter to ALL. If you wish to record only the sequencer data of a specific MIDI channel, select that MIDI channel. Normally, this parameter is set to ALL.

- Poly Aft (Polyphonic aftertouch)
- Ctrl Change (Control change)
- Prog Change (Program change)
- Channel Aft (Channel aftertouch)
- Pitch Bend (Pitch bend)
- Sys.Excl (System exclusive message)

- 4 After you've completed settings, press [EXIT] or [F3] (Rec Sel) to close the Recording Select window.

Changing the Phrase track during recording (Non-stop Loop Recording)

The XP-80 allows you to change the recording destination Phrase track during loop recording. This will reduce having to press [STOP/PLAY] repeatedly when recording your performance on several Phrase tracks, and let you create a song right away.

- * A Phrase track cannot be selected when you are recording in a Pattern, or vice versa.

<Procedure>

- 1 Make sure that loop recording is underway.
- 2 Move the cursor to "TRK."
- 3 Press TRACK/PART [1]-[16] to select a different Phrase track.

Right after you select a Phrase track, sequencer data will be recorded on the selected Phrase track.

- * If you've selected Performance mode, selecting another Phrase track will also select the correspondingly numbered Part. To select another Phrase track only (without selecting the correspondingly numbered Part), change the Phrase track by turning the VALUE dial or pressing [INC]/[DEC].

Checking instrument sounds or phrases during recording (Rehearsal)

If you use the Rehearsal function during realtime recording, your performance will not record while Rehearsal is on. This is convenient for checking the instrument sound you'll play next or for practicing the next phrase you'll be recording, while recording drums or performing non-stop loop recording.

<Procedure>

- 1 Press [F6] (Rehrrsal) during realtime recording.
- "■" will appear next to Rehrrsal, showing that the rehearsal mode is active.

- * The Rehearsal function will be invalid during manual punch-in recording.

- 2 To return to the Recording mode, press [F6] (Rehrrsal) again.

Deleting unwanted data during recording (Realtime Erase)

Realtime Erase is for erasing unwanted data during mix recording. For example, when using the Loop function to mix-record rhythm instruments, you can use Realtime Erase to delete a specific rhythm instrument.

<Procedure>

- ❶ During mix recording, press [F5] (Erase) to open the Realtime Erase window.

Now Realtime Erase is active and recording is not possible.



- ❷ Erase the unwanted data.

To erase all data recorded on the track (except for Pattern Call messages), press [F6] (ErsAll). If you continue pressing this button, all data recorded on that track will be erased.

To erase notes corresponding to a specific key, press that key. If you continue pressing the key, all notes with the corresponding note number will be erased.

To erase notes of a specific keyboard area, press the desired area's lowest and highest keys. If you continue pressing the keys, all notes in that area will be erased.

- * If you have selected a specific MIDI channel in the Recording Select window, only the data of that MIDI channel will be erased.
- ❸ To return to the recording mode, press [EXIT] to close the Realtime Erase window.

Recording tempo changes

For changing tempo in a song, you can record tempo changes on the Tempo track. If the Tempo track already contains tempo changes, they will be rewritten by your new tempo changes.

<Procedure>

- ❶ Make sure that the song you want to put tempo changes in has been loaded into internal memory.
- * Tempo changes cannot be recorded in a song which contains no sequencer data on the Phrase tracks. Tempo changes should be recorded after all your performance has been recorded.
- ❷ Press [REC].
- ❸ Press [TEMPO/BEAT] to select the Tempo track.

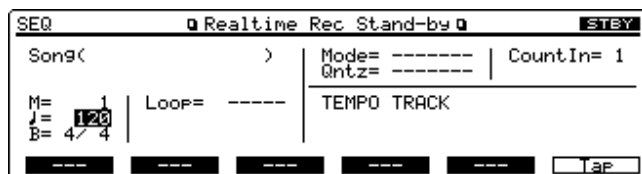

- ❹ Move the cursor to "M" and set the measure at which you want to begin recording tempo changes.

- ❺ Move the cursor to "Count In" and specify the recording start method.
- ❻ Recording will begin according to the method specified by "Count In."

As soon as recording begins, song playback will start.

- ❼ Change the tempo.

Input a tempo at the Song position you want to change tempo, using the numeric keys.

For gradual tempo changes like ritardando and accelerando, use the VALUE dial or [INC]/[DEC]. You can also use the Tap Tempo function to specify tempo changes. In that case, it is also possible to change tempo by pressing [F6] (Tap) instead of the pedal switch.

- ❽ When you finish, press [STOP/PLAY].
- * When the playback reaches song end, the recording of tempo changes will also stop automatically.

Changing instrument during recording

If you select another Patch or Rhythm Set during recording, the Bank Select number and Program number of the Patch/Rhythm Set will be recorded together with the song. The same applies when selecting a different Performance.

- * If you change the Patch/Rhythm Set in the middle of a song, it's recommended that you record the initial sound source setup data for recording at the beginning of the song. When you select a Patch/Rhythm Set on the Realtime Rec Stand-by display (SEQ), the Bank Select number and Program number of that Patch/Rhythm Set will automatically be recorded at the recording start position.
- * Please be aware if you select another Patch assigned to a Part of the Performance, and the Performance Ctrl-Ch parameter (SYSTEM/MIDI/MIDI Param 1) setting corresponds to the MIDI channel of the specified Part, a new Performance will be selected instead.

<Procedure>

- ❶ Make sure you're actually recording.
- ❷ Move the cursor to the group and number and select the Patch or Rhythm Set using the numeric keys.

When selecting a different Performance, press [PERFORM] to call up the Play display (PERFORM) and select a Performance using the numeric keys. To return to the Realtime Recording display (SEQ), press [SEQUENCER].

- ❸ When you get to the Song position at which you want to change the Patch/Rhythm Set, press [ENTER] to record it within the song.

Modifying parameter values of each Part during recording

If you've selected Performance mode, you can modify parameter values of each Part during either recording or on the Realtime Rec Stand-by display (SEQ). This allows adjusting the effects balance between Parts during a song.

- * To record modified parameter settings in a song, set the Tx Edit Data parameter (SYSTEM/MIDI/MIDI Param 1) ON. As numerous System Exclusive messages are recorded, song data may increase to an unnecessary degree.
- * Your modified parameter settings will be lost if you select another Performance or turn the power off. To keep the settings, rewrite the Performance.

<Procedure>

- ❶ Press [F1] (→ Part) to call up the Part Palette display (PERFORM/Part).

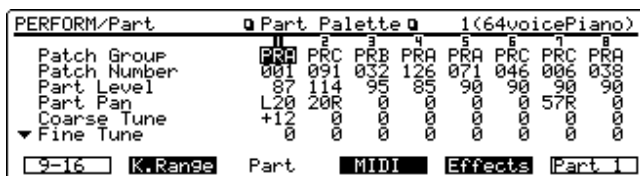

- ❷ The rest of the procedure is the same as editing in Performance mode. Move the cursor to the desired parameter and specify the value you want.

To call up another display group, press the appropriate button from [F2] (K.Range)–[F5] (Effects).

To call up the display of Parts 9–16, press [F1] (9-16).

To exit the Palette display, press [F6] (Part).

- ❸ After you finish settings, press [EXIT] or [SEQUENCER] to return to the original display.

Checking MIDI messages received by each Part during recording

If you have selected Performance mode, you can check the MIDI messages received by each Part either during recording or on the Realtime Rec Stand-by display (SEQ).

<Procedure>

- ❶ Press [F2] (→ Info) to call up the Part Information display (PERFORM/Info).



- ❷ Call up the Part Information display (PERFORM/Info) of the MIDI message you want to check by pressing the appropriate button from [F1]–[F6].
- ❸ After checking, press [EXIT] or [SEQUENCER] to return to the previous display.

Changing the sound character of each Part during recording

When adding attack or modifying decay of the Patch assigned to each Part using the Sound Palette, you can record the slider movements which modify the song's sound character. Mix-record this data after you have recorded your whole performance.

- * This also applies for recording slider movements in a song in Patch mode.

<Procedure>

- ❶ Make sure that the Realtime Rec Stand-by display (SEQ) is up.
- ❷ Move the cursor to "PART" and press TRACK/PART [1]–[16] to choose the Part you want to modify.
- * The correspondingly numbered Phrase track will be selected as the recording destination. If you wish to record slider movements on another Phrase track, move the cursor to "TRACK" and choose that track by either turning the VALUE dial or pressing [INC]/[DEC].
- ❸ Raise the sliders to their appropriate positions.
- ❹ Press [FILTER/ENV] to light the indicator.
- ❺ Begin recording as specified by "Count In."
- ❻ Move the sliders to change the sound character as desired.

To modify the brightness, move the CUTOFF slider.

To change resonance, move the RESO. slider.

To add more attack to the sound, move the ATTACK slider.

To change decay time, move the DECAY slider.

- * With a Single Performance, slider movement data for the current Part will be recorded. If you have selected a Layer Performance, slider movement data for Parts with the Local Switch parameter (PERFORM/MIDI/Part MIDI) set ON will be recorded.
- ❼ After you finish recording, press [STOP/PLAY].

Recording volume balance between Parts

You can also record the desired volume level of each Part in a song using the four sliders in the Sound Palette. Volume level data should be mixed (combined) with sequencer data, but only after all the recording of your performance is completed.

- * In Patch mode, you can also adjust volume balance between Tones and record it within a song. Use sliders 1, 2, 3, and 4 to adjust the volume level of Tones 1, 2, 3, and 4, respectively.

<Procedure>

- 1 Make sure that the Realtime Rec Stand-by display (SEQ) is up.
- 2 Move the cursor to “PART” and press TRACK/PART [1]–[16] to choose the Part you want to modify the volume level.

If you’ve selected any of Parts 1–4, sliders 1, 2, 3, and 4 adjust Parts 1, 2, 3, and 4, respectively.

If you’ve selected any of Parts 5–8, sliders 1, 2, 3, and 4 adjust Parts 5, 6, 7, and 8, respectively.

If you’ve selected any of Parts 9–12, sliders 1, 2, 3, and 4 adjust Parts 9, 10, 11, and 12, respectively.

If you’ve selected any of Parts 13–16, sliders 1, 2, 3, and 4 adjust Parts 13, 14, 15, and 16, respectively.

- * The Phrase track of the number corresponding to the selected Part will also be selected as the recording destination. If you wish to record volume data on another Phrase track, select the track by moving the cursor to “TRACK” and then turning the VALUE dial or pressing [INC]/[DEC]. Keep in mind that volume data of multiple Parts is recorded on a single Phrase track or Pattern.
- 3 To have the song fade in, set the sliders to their lowest settings. To fade out, put the sliders to their max settings. For other cases, set sliders to the appropriate settings.
- 4 Press [LEVEL] to light the indicator.
- 5 Begin recording as specified by “Count In.”
- 6 Move the sliders to adjust the volume level of each Part as desired.
- 7 After you finish volume balance adjustment, press [STOP/PLAY].

Panning Parts during recording

You can also record the desired panning (stereo location) of each Part within a song by using the Sound Palette’s four sliders. Pan data should later be mixed (combined) with sequencer data after recording all your performance. You can also control aftertouch or pitch bending depending on the setting, so the Sound Palette can also be used as a mixer.

- * If Patch mode or Rhythm Set mode has been selected, this operation cannot be executed.
- * Pan data of all Parts is recorded on the currently selected Phrase track or Pattern. Keep in mind that pan data of multiple Parts is recorded on a single Phrase track or Pattern.

<Procedure>

- 1 Make sure that the Realtime Rec Stand-by display (SEQ) is up.
- 2 Raise the sliders to appropriate positions.
- 3 Press [F2] (→ Info) to call up the Part Information display (PERFORM/Info).
- 4 Press [F5] (Pan) to call up the Part Information display (PERFORM/Info) for the Pan.

If the display does not show (Pan) for [F5], keep pressing [F6] (Menu) until it appears.

- * If you call up the Part Information display (PERFORM/Info) of another MIDI message you want to adjust, you’ll be able to control that MIDI message using the Sound Palette’s four sliders.
- 5 Move the cursor to the Part you want to pan.

You can modify the panning of the boxed four Parts using the sliders.

If you’ve selected any of Parts 1–4, sliders 1, 2, 3, and 4 adjust Parts 1, 2, 3, and 4, respectively.

If you’ve selected any of Parts 5–8, sliders 1, 2, 3, and 4 adjust Parts 5, 6, 7, and 8, respectively.

If you’ve selected any of Parts 9–12, sliders 1, 2, 3, and 4 adjust Parts 9, 10, 11, and 12, respectively.

If you’ve selected any of Parts 13–16, sliders 1, 2, 3, and 4 adjust Parts 13, 14, 15, and 16, respectively.

- 6 Begin recording as specified by “Count In.”
- 7 Move the sliders to adjust the panning of each Part as desired while confirming onscreen.
- * To return to the Realtime Recording display (SEQ), press [EXIT].
- 8 After you finish panning assignments, press [STOP/PLAY].

Canceling recording (Undo)

If you’re not happy with your most recent realtime recording take, you can delete it by pressing [UNDO/REDO]. Pressing [UNDO/REDO] again will restore the most recent take.

Inputting data step by step (Step recording)

Step recording allows you to record notes and rests one by one just like writing a score on a staff. Besides inputting notes, you can also combine Patterns to create a song.

Before starting step recording, make sure that steps 1-3 in the section "Recording process" (p.104) have been completed correctly.

- * Mix-recording data on one Phrase track is not possible when step recording. If you want to mix (combine) sequencer data into a single Phrase track, you need to conduct separate step recording sessions and merge the takes using the Track Edit function.

Inputting notes and rests

<Procedure>

- 1 Make sure that the Play display (SEQ(Song)) is up.
- 2 Move the cursor to the song number and select the song you wish to record.

If you're recording a new song, select "00:Internal Song." If you're recording over a song saved on disk, select that song number.

- 3 Move the cursor to "M" and specify the recording start position.
- 4 If you are recording a new song, move the cursor to "♪" and set the tempo.
- 5 Select the recording destination.

When recording on a Phrase track, use TRACK/PART [1]-[16]. The button indicator of the selected Phrase track will light.

When recording in a Pattern, press [PATTERN] and specify the Pattern number.

- 6 When you don't want to match the numbers of a Phrase track and Part, or when recording on a Pattern, move the cursor to "PART," then turn the VALUE dial or press [INC]/[DEC] to select the Part you want to use for recording.
 - 7 Press [F4] (Micro) to call up the Microscope display (SEQ/Micro).
- * If you have selected a song saved on disk in step 2, a window asks "This Song is not Internal Song. Load anyway?" If you want to erase the song from the internal memory and load the new song, press [F5] (OK). If you decide not to erase the song from the internal memory, press [F6] (Cancel).
- 8 Press [REC] to call up the Step Recording display (SEQ/Micro).

Phrase track/
Pattern number



- 9 Move the cursor to "Step Time" and specify the length of the note (the distance between one note-on to the next note-on) as a note value.

You can also use the numeric keys to input the note value.

- 10 Move the cursor to "Gate Ratio" (gate time ratio) and specify the time from note-on to note-off (gate time) as a percentage of the Step Time.

To enter staccato notes, set smaller values. To enter tenuto (legato) notes, set larger values. A value of about 80% is appropriate for normal notes.

- 11 Move the cursor to "Velocity" and specify the key press strength.

If you want to specify the velocity of each note with your actual key press force on the keyboard, set this parameter to "REAL." Normally, a value of 60 would be appropriate for p (piano), 90 for mf (mezzo forte) and 120 for f (forte). Refer to these when setting an velocity value.

- 12 Press the key you wish to input.

When you press a key, the MIDI channel (Ch), note name (Note), velocity (Vel) and gate time (Gate) of the note will be displayed.



- * The note will not be input until you release the key, so you are free to modify the parameter values (Step Time, Gate Ratio and Velocity).

- 13 Release the key and the note will be input.

Now you can input the next note.



- 14 Repeat steps 9 to 13 to input notes.

The parameter values of the most recent note input will be maintained. If you wish to use existing settings for the next note you input, no change is needed. Normally, Gate Ratio and Velocity parameter values hardly have to be changed once set. You just have to specify the Step parameter value and the note you wish to input.

- 15 When you finish step recording, press [EXIT] or [STOP/PLAY].

The display will return to the Microscope display (SEQ/Micro).

Inputting chords

To input a chord, press all the notes in the desired chord after setting all parameters. When you release all these notes simultaneously, the chord will be input. The next chord can then be input. Since the chord will not be input until all notes have been released, you are free to change the notes in the chord as long as one key at least remains pressed.

Inputting ties

First specify the step times of the notes to be tied, then press [F5]. The tie will be input, and the next data can be input.

For instance, if you want to tie a half note and a quarter note, first input a half note. Then specify a quarter note for Step Time and press [F5] (Tie).

Inputting a dotted note

First input an undotted note. Then set the Step Time to half the value of the most recent note input, and press [F5] (Tie). This will input the dotted note, and the next data can be input.

For instance, if you want to input a dotted quarter note, first input a quarter note. Then set Step Time to an eighth note and press [F5] (Tie).

Inputting rests

Set Step Time to the length of the desired rest, and press [F6] (Rest). This will input the rest, and the next data can be input.

Erasing wrong notes

Press [BWD] or [F2] (StpBack) and the most recent note input will be erased. The erased note will sound so you can confirm it.

<Relationship between notes and gate times>

Notes and gate times interact with each other as outlined below.

However, the gate times that will actually be recorded are determined by multiplying these values by the Gate Ratio parameter value. For instance, with a Gate Ratio of 80%, inputting ♩ will result in gate time of 77 (96×0.8).

Note	Gate time
♩	6
♪	12
♫ ₃	16
♮	24
♫ ₃	32
♩	48
♫ ₃	64
♩	96
♩	192

Assigning a Pattern to a Phrase track

When you create a song by combining pre-recorded Patterns, you can assign a Pattern on a Phrase track using step recording. However, the Phrase track contains only Pattern Call messages that instruct the Pattern to play back, not the actual data of the Pattern. If you re-record the Pattern later on, the song playback will vary.

- * When you assign a Pattern to a Phrase track and play it back, the Pattern's time signature (Pattern beat) will be ignored – instead, the time signature of the Beat track is used. If the Pattern beat and the time signature setting of the Beat track differ, the lengths of measures will not match, and playback might be skewed. If this is encountered, reset the time signature of the Beat track (p.148).

<Procedure>

- 1 Make sure that the Play display (SEQ(Song)) is up.
- 2 Move the cursor to the song number and select the song you wish to record.

If you're recording a new song, select "00:Internal Song." If you're recording over a song saved on disk, select that song number.

- 3 Move the cursor to "M" and specify the recording start position.
- 4 Move the cursor to "♩" and set the tempo.
- 5 Press [F4] (Micro).
- * If you have selected a song saved on disk in step 2, a window asks "This Song is not Internal Song. Load anyway?" If you want to erase the song from the internal memory and load the new song, press [F5] (OK). If you decide not to erase the song from the internal memory, press [F6] (Cancel).
- 6 Press TRACK/PART [1]–[16] to select Phrase track to which you want to assign a Pattern.
- 7 Press [REC] to call up the Step Recording display (SEQ/Micro).
- 8 Press [F1] (PATTERN) to prepare to assign a Pattern to the Phrase track.

The display will indicate "■" next to PATTERN.

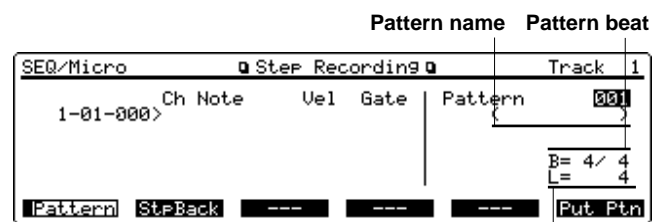

Length of measure in Pattern

- 9 Select the Pattern number you wish to assign to the track.
- 10 Press [F6] (Put Ptn).

The Pattern Call message will be input into the Phrase track and the input location will advance by the number of measures in the Pattern. You may now assign the next Pattern if desired.

- 11 Repeat steps 9 and 10 to assign other Patterns.

② To return to the display where you can input notes and rests, press [F1] (Pattern).

“■” next to PATTERN will disappear.

③ After you finish step recording, press [STOP/PLAY].

This will return to the Microscope display (SEQ/Micro).

If you input the wrong data

Press [F2] (StpBack) or [BWD] to erase the most recent Pattern Call message input.

Deleting recording (Undo)

If you're not satisfied with the most recent step recording take, delete it by pressing [UNDO/REDO]. Pressing [UNDO/REDO] again restores the most recent take.

Saving the recorded song to disk

The recorded song is temporarily stored in internal memory. This means that the song currently resident in internal memory will be lost if another song is loaded or the power is turned off. To keep the song, it must be saved to disk.

There are three methods for saving a song to disk. Select one as the situation requires.

- * If you try to save a file with a pre-existing name, a window asks “File Name duplicate. Overwrite?” To rewrite the file, press [F5] (OK). To cancel saving, press [F6] (Cancel).
- * When you try to save data to a disk which has not been formatted for the XP-60/XP-80, a window asks “Unformatted disk. Format?” When formatting the disk, press [F5] (OK). If you decide not to format the disk, press [F6] (Cancel).

Saving sound data along with a song

You can save a song, together with its sound data used for recording, as an MRC Pro song file to disk. Use this method if you going to play back the song using the same sound used for recording.

- * This method of saving a song limits MRC Pro sequencers other than the XP-80's from playing it back with correct sound. To play back with correct sound, record the corresponding Bank Select number and Program number.
- * The current Patch, Performance or Rhythm Set settings will be recorded along with the song. So if you've changed the Patch/Performance/Rhythm Set during recording and saved the recording to disk, the initial settings at recording start won't be saved. If this is the case, record the Bank Select number and Program number that correspond to the Patch/Rhythm Set used at recording start at the beginning of the song on the Microscope display (SEQ/Micro), etc.

<Procedure>

- ① Insert a disk to the disk drive.
- ② Press [DISK].
- ③ Press the numeric key [2], then [ENTER].
- ④ Move the cursor to “File Type” and select “SONG.”
- ⑤ Move the cursor to “Save Mode” and select “SONG+SOUND.”
- ⑥ Move the cursor to “File Name” and assign a file name.
- ⑦ Press [F6] (Execute) to save the song.

The file name extension “.SVQ” attaches automatically.

Saving only a song

You can save only a recorded song as an MRC Pro song file to disk, without saving the sound data used to play it.

<Procedure>

- ❶ Insert a disk into the disk drive.
- ❷ Press [DISK].
- ❸ Press the numeric key [2], then [ENTER].
- ❹ Move the cursor to “File Type” and select “SONG.”
- ❺ Move the cursor to “Save Mode” and select “SONG ONLY.”
- ❻ Move the cursor to “File Name” and assign a file name.
- ❼ Press [F6] (Execute) to save the song.

The file name extension “.SVQ” attaches automatically.

Saving a song in the Standard MIDI File format

You can save a recorded song in the Standard MIDI File format to disk. Use this method if you’re going to play back your song from other equipment such as external MIDI sequencer.

<Procedure>

- ❶ Insert a disk to the disk drive.
- ❷ Press [DISK].
- ❸ Press the numeric key [2], then [ENTER].
- ❹ Move the cursor to “File Type” and select “SMF-0” or “SMF-1.”

If you wish to save the entire sequencer data in a single Phrase track, choose “SMF-0.” If you wish to save sequencer data in several Phrase tracks, select “SMF-1.”

- ❺ Move the cursor to “File Name” and assign a file name.
- ❻ Press [F6] (Execute) to save the song.

The file name extension “.MID” attaches automatically.

Complete a song by editing a recorded song. When you edit a song, you're modifying a song that's already recorded into internal memory. When you're going to edit a song saved to disk, you have to first load it into the internal memory.

- * The internal song will be lost if you turn power off or load another song into internal memory. If you wish to keep a song, save it to disk.

Sequencer operating environment setup

You can make settings for using the XP-80 in combination with an external MIDI device or make global sequencer settings like metronome settings.

- * The settings you've made on this display (excluding Sync Mode and Offset Time parameters) are retained until they are reset.

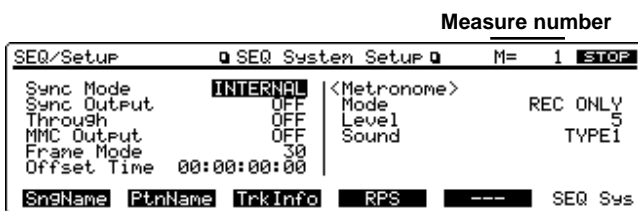

Sync Mode

Selects the MIDI clock which the XP-80's sequencer will reference for operation.

INTERNAL: The XP-80's sequencer will operate using the internal MIDI clock.

REMOTE: Essentially same as INTERNAL. However, Start/Stop messages from an external MIDI device will start/stop playback of the XP-80's sequencer.

SLAVE: The XP-80's sequencer will sync to the MIDI clock of an external MIDI device.

The XP-80's sequencer will not operate when a MIDI clock is not received from an external MIDI device.

Sync Output (MIDI sync output)

Set this parameter ON when you want synchronization related MIDI messages (MIDI Clock, Start, Continue, Stop, Song Position Pointer and Song Select) to be transmitted to an external MIDI device. If not, set it OFF.

Through (Thru function)

Thru function re-transmits all messages received at the MIDI IN connector to the MIDI OUT connector without modifying them in any way. Normally you'll leave this OFF, but when using an external sequencer, you should set it ON.

MMC Output

Set this parameter ON when you want to synchronize the XP-80's sequencer to the Roland VS-880 Hard Disk Recorder.

When set ON, MMC (MIDI Machine Control) related commands (Play, Stop and Locate) will be transmitted.

- * The XP-80 will not receive MMC related commands.

Frame Mode

Use this parameter when you want to sync the XP-80's sequencer to the VS-880. Referring to the values below, set this parameter to the same value as set for the MTC Type parameter of the VS-880.

VS-880	XP-80
24	24
25	25
29D	29D
29N	30
30	30

- * When connecting the XP-80 to the VS-880, it is recommended to set both parameters to 30.

Offset Time

Use this parameter when you want to synchronize the XP-80's sequencer to the VS-880. Set this parameter to the same value as set for the Ofs parameter of the VS-880.

Mode (Metronome mode)

Specifies when you want the metronome to sound.

OFF: Metronome will not sound at all.

REC ONLY: Metronome will sound only for recording.

REC&PLAY: Metronome will sound for playback and recording.

ALWAYS: Metronome will always sound.

Level (Metronome level)

Adjusts the metronome volume in eight steps (0 to 7).

Sound (Metronome sound)

Selects the metronome sound.

TYPE 1: A normal metronome sound will be produced. Bell will sound at the first beat.

TYPE 2: Clicks will sound.

TYPE 3: Beeps will sound.

TYPE 4: Cowbell will sound for the first beat, and wood-block on other beats.

<Procedure>

- 1 Make sure that the Play display (SEQ(Song)) is up.
- 2 Press [F1] (Setup).
- 3 Press [F6] (SEQ Sys) to call up the SEQ System Setup display (SEQ/Setup).
- 4 Move the cursor to "Sync Mode" and specify how the internal sequencer is to operate.
- 5 Move the cursor to "Sync Output" and specify how the sync-related MIDI messages are to be transmitted.
- 6 Move the cursor to "Through" and specify whether you want use Thru function or not.
- 7 When you want to sync the internal sequencer to the VS-880, move the cursor to "MMC Output," "Frame Mode," and "Offset Time" and specify each value you want.
- 8 Move the cursor to "Mode" and specify when you want the metronome to sound.
- 9 Move the cursor to "Level" and specify the metronome's volume level.
- 10 Move the cursor to "Sound" and select the metronome sound.
- 11 After you finish settings, press [EXIT] to return to the Play display (SEQ(Song)).

Settings for an entire song

You can make settings specific for each song, such as assigning song name or specifying a Locate position. These settings are saved at the same time you save a song to disk.

Naming a song (Song Name)

You can assign a new name to a song, or modify an existing name. The song name is separate from the file name. You don't have to name a song if you don't want to, but since a song name can have up to 15 characters, you can input a song title or remarks that help you to organize your songs later on.

- * Some commercial SMF data contains copyrighted information. If you load copyrighted SMF data, an indication such as "(C) 1996 Roland Corporation" will be displayed and it will not be possible to modify the song name.



<Procedure>

- ❶ Make sure that the Play display (SEQ(Song)) is up.
 - ❷ Move the cursor to the song number and select the song to which you want to assign a song name.
 - ❸ Press [F1] (Setup).
 - ❹ Press [F1] (SngName) to call up the Song Name display (SEQ/Setup).
- * If you have selected a song previously saved to disk in step 2, a window asks "This Song is not Internal Song. Load anyway?" If you want to erase the song from internal memory and load the new song, press [F5] (OK). If you decide not to erase the song from the internal memory, press [F6] (Cancel).
- ❺ Press [◀] or [▶] to move the cursor to the location where you want to input a character.
 - ❻ Input the desired character using [INC]/[DEC], the numeric keys or the VALUE dial.

When you are assigning a song name in the Name window, press [F1] (SngName).

- ❼ Repeat steps 5 and 6 to assign the song name you want.
- ❽ When you finish entering the song name, press [EXIT] to return to the Play display (SEQ(Song)).

Naming a Pattern (Pattern Name)

You can assign a new name to a Pattern, or modify the existing name. Up to 15 alphanumeric characters can be specified for the Pattern name.



<Procedure>

- ❶ Make sure that the Play display (SEQ(Song)) is up.
 - ❷ Move the cursor to the song number and select the song to which you want to assign a Pattern name.
 - ❸ Press [F1] (Setup).
 - ❹ Press [F2] (PtnName) to call up the Pattern Name display (SEQ/Setup).
- * If you have selected a song previously saved to disk in step 2, a window asks "This Song is not Internal Song. Load anyway?" If you want to erase the song from the internal memory and load the new song, press [F5] (OK). If you decide not to erase the song from the internal memory, press [F6] (Cancel).
- ❺ Press [PATTERN] to open the Pattern Select window and select the Pattern number.
 - ❻ Press [◀] or [▶] to move the cursor to the location where you want to input a character.
 - ❼ Input the desired character using [INC]/[DEC], the numeric keys or the VALUE dial.

When you are assigning a Pattern name in the Name window, press [F2] (PtnName).

- ❸ Repeat steps 6 and 7 to assign the Pattern name you want.
- ❽ When you finish entering the Pattern name, press [EXIT] to return to the Play display (SEQ(Pattern)). To return to the Play display (SEQ(Song)), press [EXIT] again.

Monitoring Phrase track data and settings

You can check whether each Phrase track contains data or not and whether it plays back or is muted, or modify assignment settings. The output destination for each Phrase track's data can also be specified.

Measure number									
Track	Output	Status	Ch=1	5	9	13	Ex	Ptn	
1	BOTH	PLAY	*--	---	---	---	*	-	
2	BOTH	PLAY	*--	---	---	---	-	-	
3	BOTH	PLAY	---	*	---	---	-	-	
4	BOTH	PLAY	---	*	---	---	-	-	

Output (Phrase track output assign)

Specifies the output destination of data recorded on each Phrase track.

INT: The data will be transmitted to the XP-80's internal sound source.

MIDI: The data will be transmitted to external MIDI devices via the MIDI OUT.

BOTH: The data will be transmitted to both of the above destinations.

Status (Phrase track status)

Specifies whether each Phrase track will play back (PLAY) or be muted (MUTE). A Phrase track containing no data will be indicated as "EMPTY."

- * Selecting PLAY or MUTE by pressing TRACK/PART [1]-[16] on the Play display (SEQ(Song)) will also change this setting.
- * If the display indicates "EMPTY," the track cannot PLAY or MUTE.

Track Monitor

Displays the MIDI channel (Ch) on which each Phrase track or Pattern contains data and if it contains or does not contain any System Exclusive (Ex) or Pattern Call messages (P). A "*" symbol indicates data exists and a "-" symbol indicates data does not exist.

- * "Now Playing" will appear when a song is playing back. It is not possible to monitor a Phrase track at that time.

<Procedure>

- ① Make sure that the Play display (SEQ(Song)) is up.
 - ② Move the cursor to the song number and select the song in which you want to monitor each Phrase track.
 - ③ Press [F1] (Setup).
 - ④ Press [F3] (TrkInfo) to call up the Track Information display (SEQ/Setup).
- * If you have selected a song previously saved to disk in step 2, a window asks "This Song is not Internal Song. Load anyway?" If you want to erase the song from the internal memory and load the new song, press [F5] (OK). If you decide not to erase the song from the internal memory, press [F6] (Cancel).

- ⑤ To change the Phrase track being displayed, press the appropriate button from TRACK/PART [1]-[16].

To display a Pattern, press [PATTERN] and input the Pattern number.

- ⑥ Move the cursor to "Output" and specify the data output destination.
- ⑦ Move the cursor to "Status" and set PLAY or MUTE.
- ⑧ Use Track Monitor to check data recorded on each Phrase track or Pattern.
- ⑨ After you finish making settings for each Phrase track/Pattern and checking it, press [EXIT] to return to the Play display (SEQ(Song)).

Locate function

Convenient Locate positions can be recorded to indicate any position in a song or Pattern. In general, a song position is referred to by a "measure-beat-clock" and the corresponding time "hour:minute:second:frame" will also be displayed. This lets you specify the same position regardless of the locate method you use. Selecting a Locate position that has been recorded will take you right to that position during playback. Recording Locate positions is a convenient way to specify a track editing area, Loop points, and an auto punch-in recording area.

- * The Locate function cannot be used when a song stored on disk is selected, or the current display has no indication of measure number or "measure-beat-clock."
- * If the song's time signature and the Pattern's time signature (Pattern beat) differ from each other, selecting the same Locate position will result in different positions in the song and Pattern.
- * Refer to page 122, page 120 and page 108 for using Locate positions to respectively specify the track editing area, Loop points, and auto punch-in recording area.

Recording a Locate position

Each song can record up to eight different Locate positions. Since you can also fine-tune Locate positions that have already been recorded, you can just roughly record Locate positions while playing back or recording a song, then go back and adjust them.

LOC0 (Rec Top) is automatically set to the position where recording began and LOC9 (Rec End) to the position where recording ended.

- * If you save the song as an MRC Pro song, Locate positions will be stored as part of the song data.

<Procedure>

- 1 Press [LOCATE] to open the Locate window.

“Cur” shows the current song position. The displayed position will be recorded as the Locate position. Although a “***” symbol is displayed for the clock or frame during playback or recording, the displayed position’s clock or frame will actually be recorded.

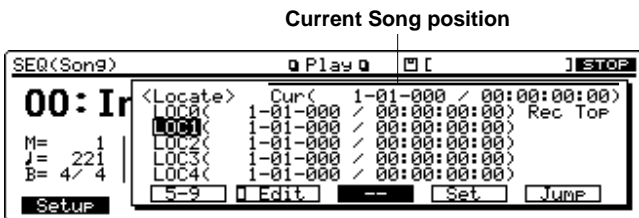

- 2 Turn the VALUE dial, or press the numeric keys, [INC], [DEC], [▲] or [▼] to move the cursor to the Locate number (LOC1-LOC8) for which you want to specify a Locate position.

To select a Locate position LOC5-LOC9 when LOC0-LOC4 are displayed, press [F2] (5-9). Press [F2] (0-4) for vice versa.

- 3 Press [F5] (Set) to input the Locate position when the desired Song position is reached during playback or recording.

When the Locate position has been set, the Locate window closes.

- * The Locate position can also be set by inputting a Locate number as you hold down [SHIFT], instead of pressing [F5] (Set).

Fine-tuning the Locate position

You can fine-tune the Locate position you set during playback or recording. If you have a definite position to specify as the Locate position, enter the value by either the “measure-beat-clock” or “time:minute:second:frame” form.

<Procedure>

- 1 Make sure that the Locate window is open.
- 2 Press [F3] (Edit).

The parentheses () indication for “measure-beat-clock” or the time will disappear, showing that you are now ready to fine-tune the Locate position. A “■” symbol will appear next to Edit.

- * LOC0 (Rec Top) and LOC9 (Rec End) cannot be reset.
- 3 Move the cursor to the desired measure-beat-clock or hour:minute:second:frame.
- 4 Use the numeric keys to input the value you want.

- 5 Close the Locate window after you finish settings by pressing [LOCATE] or [EXIT].

To return to the display for normal Locate position settings, press [F3] (Edit) again.

Moving right to a Locate position

<Procedure>

- 1 Press [LOCATE] to open the Locate window.
- 2 Turn the VALUE dial, or press the numeric keys, [INC], [DEC], [▲] or [▼] to move the cursor to the desired Locate number (LOC0-LOC9).
- 3 Press [F6] (Jump) to move right to the specified Locate position.

When the Locate position has been moved, the Locate window closes.

- * Inputting a Locate number using the numeric keys allows you to move right to the specified Locate position without pressing [F6] (Jump).

Setting loop

During loop play or recording, a section you specify here (loop area) will play back or be recorded repeatedly. You can set the repeat number and the Loop points to specify the loop area.

- * If the song’s time signature and the Pattern’s time signature (Pattern beat) differ from each other, Loop point will result in different positions in the song and Pattern.
- * If you save the song as an MRC Pro song, Loop settings will be stored as part of the song data.

<Procedure>

- 1 Make sure that the Play display (SEQ(Song)) or Realtime Rec Stand-by display (SEQ) is up.
- * Loop points will be the same regardless of the display you used for setting them.
- 2 Press [F5] (Loop) to open the Loop window.



- * If you have selected a song previously saved to disk in step 2, a window asks “This Song is not Internal Song. Load anyway?” If you want to erase the song from the internal memory and load the new song, press [F5] (OK). If you decide not to erase the song from the internal memory, press [F6] (Cancel).
- 3 Move the cursor to “Repeat” and select the repeat number.

INFINIT: The loop area will keep repeating until you press [STOP/PLAY].

- 1: The loop area will be repeated once.
- 2: The loop area will be repeated twice.
- 3: The loop area will be repeated three times.

- ④ If you want to loop play or loop record a specific area, specify the loop area. Move the cursor to “Start” and specify the Song position at which the loop will start. Then move the cursor to “End” and specify the Song position at which the loop will end.

When setting the loop area using Locate positions, press [LOCATE] and specify the Locate number using the numeric keys.

- * The Song position specified for “End” will not be included in the loop area.
- ⑤ After you finish settings, press [EXIT] or [F5] (Loop) to close the Loop window.
- * If you want to loop play or loop record a specific area, move the cursor to “Loop” and select POINT on the Play display (SEQ(Song)) or Realtime Rec Stand-by display (SEQ).

Editing sequencer data over the specified range (Track Edit)

Track Edit lets you modify areas of sequencer data that you specify.

About Track Edit

Track Edit provides 15 types of editing functions in three menus: Menu 1–Menu 3.

Menu 1

Erase

Erases specified sequencer data areas.

Delete

Deletes specified sequencer data areas.

Copy

Copies a specified sequencer data area to another Song position.

Insert Meas (Insert measure)

Inserts blank measures into a specified position of a song.

Transpose

Transposes pitch of notes in a specified area.

Menu 2

Chg Velocity (Change velocity)

Modifies velocity of note data over the specified area.

Chg Channel (Change MIDI channel)

Transfers the data of a specified MIDI channel into a different MIDI channel.

Chg Gate Time (Change gate time)

Modifies the gate time (time from note-on to note-off) of notes over the specified area.

Merge

Merges the data of two Phrase tracks or Patterns into one track or Pattern.

Extract

Extracts part of the data from a Phrase track or Pattern, and moves it to another Phrase track or Pattern.

Menu 3

Shift Clock

Shifts the timing of the specified area’s sequencer data in 1 clock steps.

Data Thin

Thins out sequencer data.

Exchange

Switches sequencer data on two Phrase tracks or Patterns with each other.

Time Fit

Calculates or adjusts the playback time of a song.

Truncate

Deletes unnecessary blank measures at the beginning of a Phrase track or Pattern.

(Basic Procedure)

- ❶ Make sure that the Play display (SEQ(Song)) is up.
- ❷ Move the cursor to song number and select the song to edit.
- ❸ Press [F3] (TrkEdit) to call up the Track Edit Menu display (SEQ/TrkEdit).



- * If you have selected a song saved on disk in step 2, a window asks “This Song is not Internal Song. Load anyway?” If you want to erase the song from the internal memory and load the new song, press [F5] (OK). If you decide not to erase the song from the internal memory, press [F6] (Cancel).
- ❹ Press [F6] (Menu) to select the menu containing the desired function.

Each time [F6] (Menu) is pressed, the selection will cycle through Menu 1, Menu 2, and Menu 3, then back to Menu 1, and so on.

- ❺ Press an appropriate button from [F1]-[F5] to select the desired function.

The selected function’s display appears.

- * You can also select the desired function by pressing [INC]/[DEC] or cursor buttons, or turning the VALUE dial to move the cursor, and pressing [ENTER]. You can also select the desired function by inputting the number assigned to the function with its respective numeric key and pressing [ENTER].
- ❻ In the upper <Target> section of the display, select the track(s) to be edited.

You can select TRK 1-TRK 16 by pressing TRACK/PART [1]-[16].

TRK T can be selected by pressing [TEMPO/BEAT].

You can select PTN 001-PTN 100 by pressing [PATTERN] and specifying a Pattern number.

To specify the editing area, refer to “Setting the editing area”.

- * Since two tracks or Patterns only are needed for the Copy, Merge and Extract functions, you’ll specify <Source> and <Dest.> (Destination), instead. The procedure is the same for setting Target.
- * Once you set Target, the setting is retained for other track editing.
- ❼ Set the parameters of various functions in the lower section of the display.
- ❽ Press [F6] (Execute) to execute the operation.

After the operation is completed, the display indicates “COMPLETE.”

- * To interrupt operation, press [EXIT].
- * If you don’t like the change you’ve made, you can undo the most recent track edit. Press [UNDO/REDO] to restore it to its pre-modified state.
- ❾ To return to the Track Edit Menu display (SEQ/TrkEdit), press [EXIT]. To return to the Play display (SEQ(Song)), press [EXIT] again.

Setting the editing area

- * There are two ways of setting the editing area – using measures or Locate positions. Both methods cannot be used simultaneously.

Using measure numbers

You can set the editing area by specifying the starting measure n and the number of measures m to be edited from the start measure. For example, setting “Measure 5, for 6” means track editing will take place from the beginning of measure 5 and continue to the end of measure 10.

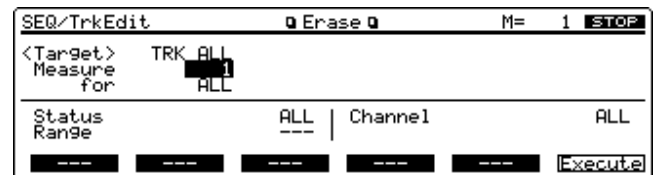

<Procedure>

- ❶ Move the cursor to “Measure” and specify the measure where you want to begin track editing.
- ❷ Move the cursor to “for” and specify number of measures that you wish to edit.

Select ALL when you want to perform track editing all the way to the end of a song.

Using Locate positions

The editing area can also be specified using Locate positions (from LOC1 to LOC2). For example, if you specify “From LOC1, to LOC2,” the editing area would extend from LOC1 position just prior to LOC2 position, but not including it.

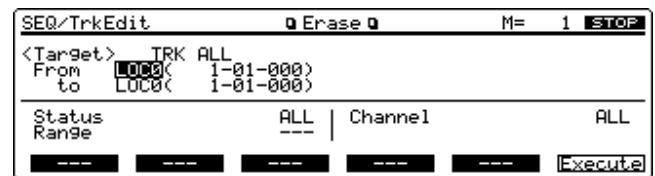

<Procedure>

- ❶ Press [LOCATE] to light the indicator.
- ❷ Move the cursor to “From” and select the Locate number from where you want to begin editing.
- ❸ Move the cursor to “to” and select the Locate number where you want editing to end.
- ❹ To return to assigning the editing area by measures, press [LOCATE] to turn off the indicator.

Erasing data input mistakes – 1 Erase

This function erases all the sequencer data inside the specified area. As the erased data is replaced by rests, the original measures will remain.

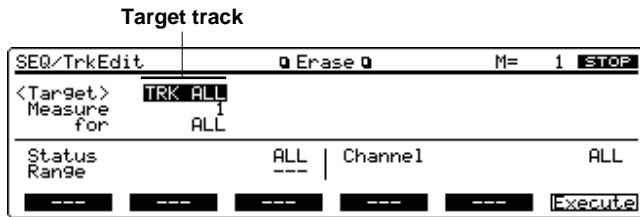

Target track

Selects the track(s) or Pattern from which data will be erased.

TRK ALL: Phrase tracks 1–16, the Beat track, and the Tempo track

TRK 1–TRK 16: The specified Phrase track

TRK T: The Tempo track

PTN 001–PTN 100: The specified Pattern

Measure (From), for (to) (Editing area)

Specifies the area from which data will be erased.

Status

Selects the type of data to be erased.

ALL: All types of sequencer data

NOTE: Note

P.AFT: Polyphonic Aftertouch

C.C: Controller numbers

PROG: Program numbers

C.AFT: Channel Aftertouch

BEND: Pitch Bend

EXC: System Exclusive messages

TUNE: Tune Request

PTN: Pattern Call messages

* If the Target parameter is set to TRK T, the Status parameter will not be available.

Range

If you have selected NOTE, P.AFT, C.C or PROG for the Status parameter, use this parameter to set the area.

To erase all Note or Polyphonic Aftertouch data, specify “C-1–G9.” To erase C4 Note/Polyphonic Aftertouch data, specify “C4–C4.” To erase Note/Polyphonic Aftertouch data from C3 to C4, specify “C3–C4.”

To erase all Controller numbers or Program numbers, specify “0–127.” To erase number 4, specify “4–4.” To erase numbers from 3 to 14, specify “3–14.”

Channel (MIDI channel)

Selects the MIDI channel of the data to be erased.

When you want to erase all sequencer data, set this parameter to ALL. To erase sequencer data of one specific MIDI channel only, select that MIDI channel.

* If you set the Target parameter to TRK T, or if the Status parameter is set to EXC, TUNE or PTN, the Channel parameter will not be available.

<Procedure>

- ❶ Make sure that the Track Edit Menu display (SEQ/TrkEdit) is up.
- ❷ Press [F6] (Menu) to select Menu 1, then press [F1] (Erase) to call up the Erase display (SEQ/TrkEdit).

This display can also be called up by moving the cursor to “1 Erase” and pressing [ENTER] on the Track Edit Menu display (SEQ/TrkEdit). Or press the numeric key [1] and press [ENTER].

- ❸ Move the cursor to Target track and select the track(s) or Pattern from which you want to erase data.
- ❹ When assigning the editing area by measures, move the cursor to “Measure” and specify the measure number at which erasing will begin, then move the cursor to “for” to specify the measure length to be erased.

When using Locate positions, press [LOCATE], and move the cursor to “From” to select the Locate number from where you want erasing to begin. Then move the cursor to “to” and select the Locate number where you want erasing to end.

- ❺ Move the cursor to “Status” to select the data to be erased.

If you select NOTE, P.AFT, C.C or PROG, move the cursor to “Range” and specify the area. The key areas for NOTE or P.AFT can be specified by pressing keys on the keyboard of the XP-60/XP-80.

- ❻ Move the cursor to “Channel” and select the MIDI channel from which you want to erase data.
- ❼ Press [F6] (Execute) to begin erasing.

Deleting unwanted data portions – 2 Delete

This function deletes a specified area of sequencer data, and moves the subsequent data to fill the gap. As a result, the measure length will be shortened by the number of deleted measures.

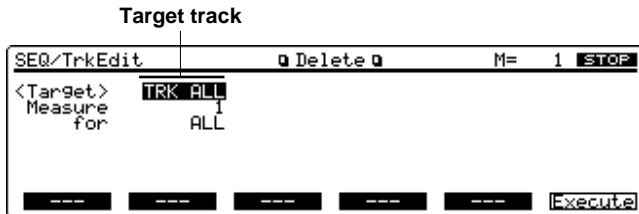

Target track

Selects the track(s) or Pattern from which data will be deleted.

TRK ALL: Phrase tracks 1–16, the Beat track, and the Tempo track

TRK 1–TRK 16: The specified Phrase track

TRK T: The Tempo track

PTN 001–PTN 100: The specified Pattern

Measure (From), for (to) (Editing area)

Specifies the area from which data will be deleted.

<Procedure>

- ❶ Make sure that the Track Edit Menu display (SEQ/TrkEdit) is up.
- ❷ Press [F6] (Menu) to select Menu 1, then press [F2] (Delete) to call up the Delete display (SEQ/TrkEdit).

This display can also be called up by moving the cursor to “2 Delete” and pressing [ENTER] on the Track Edit Menu display (SEQ/TrkEdit). Or press the numeric key [2] and press [ENTER].

- ❸ Move the cursor to Target track and select the track(s) or Pattern from which you want to delete data.
- ❹ When assigning editing area by measures, move the cursor to “Measure” and specify the measure number at which you want deletion to begin, then move the cursor to “for” to specify the measure length to be deleted.

When using Locate positions, press [LOCATE], and move the cursor to “From” to select the Locate number at which you want deleting to begin. Then move the cursor to “to” and select the Locate number at which you want deleting to end.

- ❺ Press [F6] (Execute) to begin deleting.

Copying a phrase – 3 Copy

This function copies a specified area of sequencer data. It is convenient for repeating the same phrase several times. You can copy Patterns to a Phrase track, or copy data from a Phrase track to a Pattern.

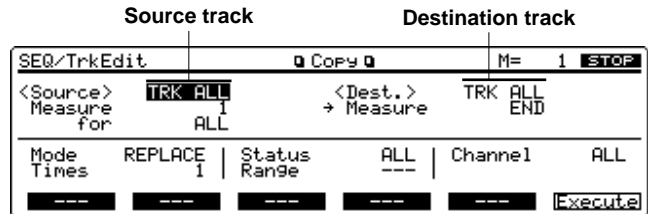

Source track

Selects the copy source track(s) or Pattern.

TRK ALL: Phrase tracks 1–16, the Beat track, and the Tempo track

TRK 1–TRK 16: The specified Phrase track

TRK T: The Tempo track

PTN 001–PTN 100: The specified Pattern

Measure (From), for (to) (Editing area)

Specifies the area from which data will be copied.

Destination track

Selects the copy destination track(s) or Pattern.

TRK ALL: Phrase tracks 1–16, the Beat track, and the Tempo track

TRK 1–TRK 16: The specified Phrase track

TRK T: The Tempo track

PTN 001–PTN 100: The specified Pattern

- * If you set the Source track parameter to TRK ALL, the Destination track parameter can be set to either TRK ALL or PTN 001–PTN 100. If you select PTN 001–PTN 100, the data from the 16 Phrase tracks will be merged as it is copied.

- * If you set the Source track parameter to TRK T, the Destination track parameter will be set to TRK T.

Measure (Destination measure)

Specifies the copy destination measure.

If you want the copy destination to be right after the last measure of a song, set this parameter to END.

Mode (Copy mode)

Specifies whether you want to preserve the existing data in the copy destination when copying.

MIX: Combines the data from the copy source with the existing data in the copy destination.

REPLACE: All the data in the copy destination will be overwritten by the copy source data. Only the sequencer data of the MIDI channels specified by the Channel parameter will be overwritten, and data of other MIDI channels will remain.

Times (Copy times)

Specifies the number of times that the data will be copied to the copy destination.

Status

Selects the type of data to be copied.

ALL: All types of sequencer data

NOTE: Note

P.AFT: Polyphonic Aftertouch

C.C: Controller numbers

PROG: Program numbers

C.AFT: Channel Aftertouch

BEND: Pitch Bend

EXC: System Exclusive messages

TUNE: Tune Request

PTN: Pattern Call messages

* If the Source track parameter is set to TRK T, the Status parameter will not be available.

Range

If you have selected NOTE, P.AFT, C.C or PROG for the Status parameter, use this parameter to set the area.

To copy all Note or Polyphonic Aftertouch data, specify "C-1-G9." To copy C4 Note/Polyphonic Aftertouch data, specify "C4-C4." To copy Note/Polyphonic Aftertouch data from C3 to C4, specify "C3-C4."

To copy all Controller numbers or Program numbers, specify "0-127." To copy number 4, set "4-4." To copy numbers from 3 to 14, specify "3-14."

Channel (MIDI channel)

Selects the MIDI channel of the data to be copied.

When you want to copy all the sequencer data, set this parameter to ALL. To copy only the sequencer data of a specific MIDI channel, select the MIDI channel.

* If you set the Source track parameter to TRK T, or if the Status parameter is set to EXC, TUNE or PTN, the Channel parameter will not be available.

<Procedure>

- ❶ Make sure that the Track Edit Menu display (SEQ/TrkEdit) is up.
- ❷ Press [F6] (Menu) to select Menu 1, then press [F3] (Copy) to call up the Copy display (SEQ/TrkEdit). This display can also be called up by moving the cursor to "3 Copy" and pressing [ENTER] on the Track Edit Menu display (SEQ/TrkEdit). Or press the numeric key [3] and press [ENTER].
- ❸ Move the cursor to Source track and select the track(s) or Pattern from which you want to copy data.

- ❹ When setting the copy source area by measures, move the cursor to "Measure" and specify the measure number at which copying will begin, then move the cursor to "for" to specify the measure length to be copied.

When using Locate positions, press [LOCATE], and move the cursor to "From" to select the Locate number at which you want copying to begin. Then move the cursor to "to" and select the Locate number at which you want copying to end.

- ❺ Move the cursor to the Destination track and select the copy destination track(s) or Pattern.
- ❻ Press [▼] to move the cursor to "Measure" and specify the copy destination.

Set the copy destination area using the same procedure as specifying the copy source area.

- ❼ Move the cursor to "Mode" and select the copying method.
- ❽ Move the cursor to "Times" and specify the number of times you want the data copied.
- ❾ Move the cursor to "Status" to select the data to be copied.

If you have selected NOTE, P.AFT, C.C or PROG for Status, move the cursor to "Range" and specify the area. The key areas for NOTE or P.AFT can be specified by pressing keys on the keyboard.

- ❿ Move the cursor to "Channel" and select the MIDI channel from which you want to copy data.
- ⓫ Press [F6] (Execute) to begin copy.

Inserting blank measures – 4 Insert Meas (Insert measure)

This function inserts blank measures into a specified Song position. As you can set the time signature of the blank measures, this is convenient when inserting a phrase having a different time signature in the middle of a song.

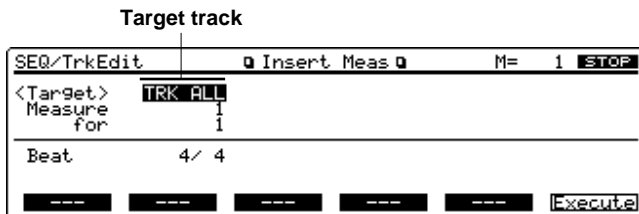

Target track

Selects the track(s) or Pattern into which blank measures will be inserted.

TRK ALL: Phrase tracks 1–16, the Beat track, and the Tempo track

TRK 1–TRK 16: The specified Phrase track

TRK T: The Tempo track

PTN 001–PTN 100: The specified Pattern

Measure (From), for (to) (Editing area)

Measure (From) specifies the Song position at which blank measures will be inserted. The 'for' parameter specifies the number of blank measures to be inserted. If you want to insert a blank measure right after the last measure of the song, set "Measure" to END.

Beat

In general, the time signature of the measure immediately before insertion will be used for the blank measures. To change the time signature of the blank measures to be inserted, use the Beat parameter.

- * Beat can be specified only when you have set the Target parameter to TRK ALL.

<Procedure>

- 1 Make sure that the Track Edit Menu display (SEQ/TrkEdit) is up.
- 2 Press [F6] (Menu) to select Menu 1, then press [F4] (Insert) to call up the Insert Meas display (SEQ/TrkEdit).

This display can also be called up by moving the cursor to "4 Insert" and pressing [ENTER] on the Track Edit Menu display (SEQ/TrkEdit). Or press the numeric key [4], then [ENTER].

- 3 Move the cursor to Target track and select the track(s) or Pattern into which you want to insert blank measures.
- 4 When setting the insertion destination by a measure, move the cursor to "Measure" and specify the measure number at which blank measures will be inserted.

When using Locate positions, press [LOCATE], and move the cursor to "From" to select the Locate number from which you want to insert blank measures.

- 5 Move the cursor to "for" and specify the number of blank measures to be inserted.
- 6 If you have set the Target track to TRK All, move the cursor to "Beat" and set the time signature of the blank measures to be inserted.
- 7 Press [F6] (Execute) to insert blank measures.

Transposing the pitch – 5 Transpose

This transposes the pitch of notes within a specified area, over a +/-99 semitone range. Use this function to modulate from one key to another in a song, or to transpose the entire song.

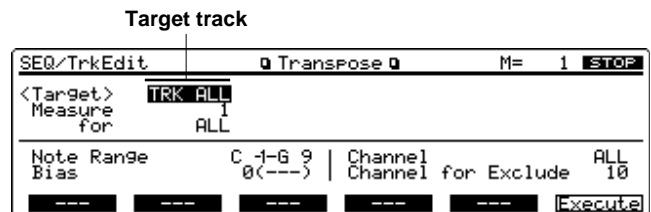

Target track

Selects the Phrase track(s) or Pattern that will be transposed.

TRK ALL: Phrase tracks 1–16

TRK 1–TRK 16: The specified Phrase track

PTN 001–PTN 100: The specified Pattern

Measure (From), for (to) (Editing area)

Specifies the area of measures that will be transposed.

Note Range

Specifies the range of note numbers to be transposed. For instance if you wish to transpose all notes within the C3 to C4 range, set this parameter to "C3–C4."

Bias

Specifies the transpose amount in semitone steps. A setting of +1 raises notes by a semitone. A setting of -1 lowers notes by a semitone. A setting of 0 will not transpose notes. If you have set the Note Range parameter to a single note, the destination note name will be displayed in parentheses ().

Channel (MIDI channel)

Specifies the MIDI channel(s) of the notes to be transposed.

Set this parameter to ALL for transposing all notes. When transposing only the notes of specific MIDI channel(s), select the MIDI channel(s) using this parameter.

Channel for Exclude (Exclude channel)

If you have selected ALL for the Channel parameter, you can specify one MIDI channel to be excluded from transposition.

For example, if you transpose the pitch of notes with the Target track parameter set to ALL and the Channel parameter to ALL, your drum notes will also be transposed. In other words, percussion sounds will change, making it impossible to play rhythm instruments as you wish. This can be avoided by setting the Channel for Exclude parameter to 10. The MIDI channel 10 (drum part) will not be transposed and the original percussion sound will be retained.

<Procedure>

- ❶ Make sure that the Track Edit Menu display (SEQ/TrkEdit) is up.
- ❷ Press [F6] (Menu) to select Menu 1, then press [F5] (Trans) to call up the Transpose display (SEQ/TrkEdit).

This display can also be called up by moving the cursor to “5 Transpose” and pressing [ENTER] on the Track Edit Menu display (SEQ/TrkEdit). Or press the numeric key [5], then [ENTER].

- ❸ Move the cursor to Target track and select the Phrase track(s) or Pattern from which you want to transpose.
- ❹ When assigning the editing area by measures, move the cursor to “Measure” and specify the measure number at which transpose is to start, then move the cursor to “for” to specify the measure length to be transposed.

When using Locate positions, press [LOCATE], and move the cursor to “From” to select the Locate number where you want transposition to begin. Then move the cursor to “to” and select the Locate number at which you want to end transposition.

- ❺ Move the cursor to “Note Range” and set the range of notes to be transposed.

You can also set this parameter through key input on the keyboard.

- ❻ Move the cursor to “Bias” and set the transpose amount.
- ❼ Move the cursor to “Channel” and select the MIDI channel(s) of notes to be transposed.

If you have selected ALL, move the cursor to “Channel for exclude” and select a single MIDI channel that will not be transposed.

- ❽ Press [F6] (Execute) to initiate transposition.

.....
<When you want to lower bass by 1 octave...>

If your bass is played 1 octave higher than the staff notation, use the Transpose function to lower it 1 octave.

To lower bass by 1 octave, set the Note Range parameter to “lowest note-highest note” of the bass staff notation, and set the Bias parameter to “-12.”

<When you want to change percussion sounds...>

You can also use the Transpose function to change percussion sounds. Suppose you want to change conga to tom. If conga is assigned to note D4 note and tom to note C3, set the Note Range parameter to “D4-D4”. To set the Bias parameter, move the cursor to “Bias,” and press C3 key to specify “-14 (C3).”

- * Only when the Note Range parameter is set in the form of a single note will the note name appear in parentheses () next the Bias parameter for reference.
-

Modifying velocity – 6 Chg Velocity (Change velocity)

This function modifies the keyboard playing dynamics (velocity) of a specified note area.

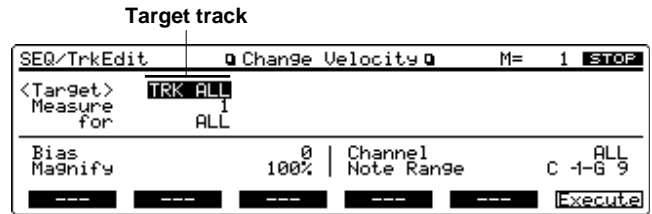

Target track

Selects the Phrase track(s) or Pattern whose velocity you want to modify.

TRK ALL: Phrase tracks 1–16

TRK 1–TRK 16: The specified Phrase track

PTN 001–PTN 100: The specified Pattern

Measure (From), for (to) (Editing area)

Specifies the area of measures over which velocity will be modified.

Bias

Use this parameter to add a fixed bias amount to all velocities. A setting of +10 will increase all velocities by 10.

Magnify

Set this parameter if increases or decreases in velocity variations are desired. For less velocity variation, use settings of 99% or less. For more velocity variation, set it to 101% or greater. With a setting of 100%, velocity values do not change.

Channel (MIDI channel)

Specifies the MIDI channel(s) of notes for which velocity will be modified.

To modify velocity for all notes, set this parameter to ALL. When modifying the velocity for only the notes of a specific MIDI channel, select that MIDI channel using this parameter.

Note Range

Specifies the range of note numbers for which velocity will be modified. For instance, to modify velocity for C3 to C4 note range, set this parameter to “C3–C4.”

<Procedure>

- ❶ Make sure that the Track Edit Menu display (SEQ/TrkEdit) is up.
- ❷ Press [F6] (Menu) to select Menu 2, then press [F1] (Chg Vel) to call up the Change Velocity display (SEQ/TrkEdit).

This display can also be called up by moving the cursor to “6 Chg Velocity” and pressing [ENTER] on the Track Edit Menu display (SEQ/TrkEdit). Or press the numeric key [6], then [ENTER].

- ❸ Move the cursor to Target track and select the Phrase track(s) or Pattern whose velocity you want to modify.
- ❹ When assigning editing area by measures, move the cursor to “Measure” and specify the measure number at which velocity change is to begin, then move the cursor to “for” to specify the measure length over which velocity will change.

When using Locate positions, press [LOCATE], and move the cursor to “From” to select the Locate number at which you want velocity to start changing. Move the cursor to “to” and select the Locate number at which you want velocity change to end.

- ❺ Move the cursor to “Bias” and set the amount of velocity addition.
- ❻ Move the cursor to “Magnify” and set the ratio of velocity variation.
- ❼ Move the cursor to “Channel” and select the MIDI channel(s) of notes for which velocity will be modified.
- ❽ Move the cursor to “Note Range” and set the note number range over which velocity will be modified.

You can also set this parameter through key input on the keyboard.

- ❾ Press [F6] (Execute) to begin velocity change.

Changing MIDI channel – 7 Chg Channel (Change MIDI channel)

This function transfers the MIDI channel of a specified area of sequencer data into a different MIDI channel.

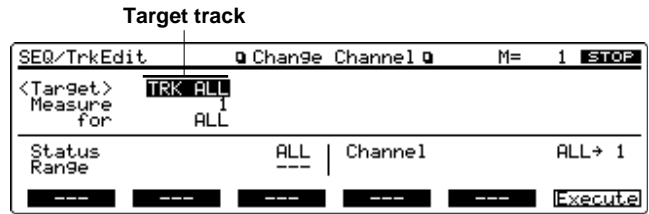

Target track

Selects the Phrase track(s) or Pattern in which you want to reassign the MIDI channel of the data.

TRK ALL: Phrase tracks 1-16

TRK 1-TRK 16: The specified Phrase track

PTN 001-PTN 100: The specified Pattern

Measure (From), for (to) (Editing area)

Specifies the area of measures for which the MIDI channel will be changed.

Status

Selects the type of data for which you wish to change the MIDI channel.

ALL: All types of sequencer data

NOTE: Note

P.AFT: Polyphonic Aftertouch

C.C: Controller numbers

PROG: Program numbers

C.AFT: Channel Aftertouch

BEND: Pitch Bend

Range

If you have selected NOTE, P.AFT, C.C or PROG for the Status parameter, use this parameter to set the area.

To change all MIDI channels of Note or Polyphonic Aftertouch data, specify “C-1-G9.” To change the MIDI channel of C4 Note/Polyphonic Aftertouch data, specify “C4-C4.” To change the MIDI channels of Note/Polyphonic Aftertouch data of a C3 to C4 range, specify “C3-C4.”

To change the MIDI channels of all Controller numbers or Program numbers, set “0-127.” To change the MIDI channel of number 4, set “4-4.” To change the MIDI channels of numbers 3 to 14, set this parameter to “3-14.”

Channel (MIDI channel)

Set the source MIDI channel at the left section of this parameter and destination MIDI channel at the right section.

If you have selected ALL for the source MIDI channel, the sequencer data of all MIDI channels will be combined into the destination MIDI channel.

* It is not possible to select ALL for the destination MIDI channel.

<Procedure>

- ❶ Make sure that the Track Edit Menu display (SEQ/TrkEdit) is up.
- ❷ Press [F6] (Menu) to select Menu 2, then press [F2] (Chg Ch) to call up the Change Channel display (SEQ/TrkEdit).

This display can also be called up by moving the cursor to “7 Chg Channel” and pressing [ENTER] on the Track Edit Menu display (SEQ/TrkEdit). Or press the numeric key [7], then [ENTER].

- ❸ Move the cursor to Target track and select the Phrase track(s) or Pattern in which you want to change the MIDI channel assign.
- ❹ When setting the editing area by measures, move the cursor to “Measure” and specify the measure number at which channel change will begin, then move the cursor to “for” to specify the measure length over which channel change will occur.

When using Locate positions, press [LOCATE], and move the cursor to “From” to select the Locate number at which you want channel change to begin. Then move the cursor to “to” and select the Locate number at which you want channel change to end.

- ❺ Move the cursor to “Status” and select the sequencer data for which the MIDI channel will be changed.

If you’ve selected NOTE, P.AFT, C.C or PROG for the Status parameter, move the cursor to “Range” and specify the area. For NOTE or P.AFT, you can specify key range by pressing keys on the keyboard.

- ❻ Move the cursor to “Channel” and set the source MIDI channel at the left section of this parameter and the destination MIDI channel at the right.
- ❼ Press [F6] (Execute) to initiate channel change.

Changing note length – 8 Chg Gate Time (Change gate time)

This function modifies the gate time (time from note-on to note-off) of notes within a specified area. Depending on the setting, you can also create staccato or tenuto.

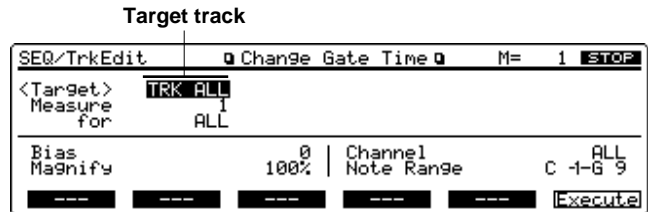

Target track

Selects the Phrase track(s) or Pattern whose gate time you want to modify.

TRK ALL: Phrase tracks 1–16

TRK 1–TRK 16: The specified Phrase track

PTN 001–PTN 100: The specified Pattern

Measure (From), for (to) (Editing area)

Specifies the area of measures over which gate time will be modified.

Bias

Set this parameter if you wish to increase or decrease all gate times by a fixed amount. With a setting of +10, all gate times will be extended by 10.

Magnify

Set this parameter if you wish to increase or decrease gate times by a specified ratio. With a setting of 100%, there will be no change. Settings of 101% or greater will extend gate times, and settings of 99% or less will reduce gate times. For example, to halve gate times, set this parameter to 50%. To double gate times, set this parameter to 200%.

Channel (MIDI channel)

Specifies the MIDI channel(s) of notes for which gate time will be modified.

If you wish to modify the gate time for notes of all MIDI channels, set this parameter to ALL. When changing the gate time for notes of a specific MIDI channel only, select that MIDI channel using this parameter.

Note Range

Specifies the range of note numbers for which gate time will be modified. For instance if you wish to modify the gate time for a note range from C3 to C4, set this parameter to “C3–C4.”

<Procedure>

- ❶ Make sure that the Track Edit Menu display (SEQ/TrkEdit) is up.
- ❷ Press [F6] (Menu) to select Menu 2, then press [F3] (Chg Gt) to call up the Change Gate Time display (SEQ/TrkEdit).

This display can also be called up by moving the cursor to “8 Chg Gate Time” and pressing [ENTER] on the Track Edit Menu display (SEQ/TrkEdit). Or press the numeric key [8], then [ENTER].

- ❸ Move the cursor to Target track and select the Phrase track(s) or Pattern whose gate time you want to modify.
- ❹ When setting the editing area by measures, move the cursor to “Measure” and specify the measure number at which gate time change will begin, then move the cursor to “for” to specify the measure length over which gate time will be modified.

When using Locate positions, press [LOCATE], and move the cursor to “From” to select the Locate number from where you want gate time change to begin. Then move the cursor to “to” and select the Locate number where you want gate time change to end. 5. Move the cursor to “Bias” and set the amount of gate time addition.

- ❺ Move the cursor to “Magnify” and set the ratio of gate time variation.
- ❻ Move the cursor to “Channel” and select the MIDI channel(s) of notes for which gate time will be modified.
- ❼ Move the cursor to “Note Range” and set the note number range in which gate time will be modified.

You can also set this parameter through key input on the keyboard.

- ❽ Press [F6] (Execute) to begin gate time change.

Combining two Phrase Tracks/Patterns into one – 9 Merge

This function merges (combines) sequencer data of two Phrase tracks or Patterns into one (of them).



Source track

Selects one of the Phrase tracks or Patterns to be merged. After merging is completed, original sequencer data in this track or Pattern will be erased.

TRK 1–TRK 16: The specified Phrase track

PTN 001–PTN 100: The specified Pattern

Destination track

Selects the other Phrase track or Pattern for merging. After merging, the combined sequencer data will be inserted into this track or Pattern.

TRK 1–TRK 16: The specified Phrase track

PTN 001–PTN 100: The specified Pattern

<Procedure>

- ❶ Make sure that the Track Edit Menu display (SEQ/TrkEdit) is up.
- ❷ Press [F6] (Menu) to select Menu 2, then press [F4] (Merge) to call up the Merge display (SEQ/TrkEdit).

This display can also be called up by moving the cursor to “9 Merge” and pressing [ENTER] on the Track Edit Menu display (SEQ/TrkEdit). Or press the numeric key [9], then [ENTER].

- ❸ Move the cursor to Source track and select a Phrase track or Pattern you want to merge.
- ❹ Move the cursor to the Destination track and select the other Phrase track or Pattern to be combined (merge destination).
- ❺ Press [F6] (Execute) to merge data.
- * Source and Destination parameters cannot be set to the same setting. If you execute the operation with the same setting, the display will show “Same Track or Pattern Selected.” Select different Phrase tracks or Patterns and execute the operation again.

Extracting and moving a part of sequencer data – 10 Extract

This function extracts a specified sequencer data area from a Phrase track or Pattern and moves it to the same Song position of another Phrase track or Pattern.

It also allows you to reorganize the sequencer data for MIDI channels so each channel's data is placed in its own Phrase track– handy when the sequencer data for multiple MIDI channels has been stored together in one Phrase track (such as with Format 0 Standard MIDI files).

Source track		Destination track	
SEQ/TrkEdit		Extract	
M= 1 STOP			
<Source>	TRK 1	<Dest.>	TRK ALL
Measure for	ALL	→	
Mode	REPLACE	Status Range	ALL
		Channel	ALL
			Execute

Source track

Selects a Phrase track or Pattern from which data is to be extracted.

TRK 1–TRK 16: The specified Phrase track

PTN 001–PTN 100: The specified Pattern

Measure (From), for (to) (Editing area)

Specifies the area of measures from which data is to be extracted.

Destination track

Selects a Phrase track or Pattern into which the data will be inserted.

TRK ALL: The sequencer data of MIDI channel 1 will be moved to Phrase track 1 and MIDI channel 16's data moves to Phrase track 16.

TRK 1–TRK 16: The specified Phrase track

PTN 001–PTN 100: The specified Pattern

Mode (Extract mode)

Specifies whether you want to keep the sequencer data at the destination.

REPLACE: The data at the destination will be erased and replaced by the extracted data. However, only the data of the MIDI channels specified by the Channel parameter will be replaced, and data of other channels at the destination will remain.

MIX: The data at the destination will combine with the extracted data.

Status

Selects the type of data to be extracted.

ALL: All types of sequencer data

NOTE: Note

P.AFT: Polyphonic Aftertouch

C.C: Controller numbers

PROG: Program numbers

C.AFT: Channel Aftertouch

BEND: Pitch Bend

EXC: System Exclusive messages

TUNE: Tune Request

PTN: Pattern Call messages

Range

If you have selected NOTE, P.AFT, C.C or PROG for the Status parameter, use this parameter to specify the area.

To extract all Note or Polyphonic Aftertouch data, specify "C-1-G9." To extract C4 Note/Polyphonic Aftertouch data, specify "C4-C4." To extract Note/Polyphonic Aftertouch data over the range from C3 to C4, specify "C3-C4."

To extract all Controller numbers or Program numbers, specify "0-127." To extract Controller/Program number 4, specify "4-4." To extract Controller/Program numbers from 3 to 14, specify "3-14."

Channel (MIDI channel)

Selects the MIDI channel(s) of the data to be extracted.

To extract all sequencer data, set this parameter to ALL. To extract just the sequencer data of a specific MIDI channel, select that MIDI channel.

* If you set the Status parameter to EXC, TUNE or PTN, the Channel parameter will not be available.

<Procedure>

- 1 Make sure that the Track Edit Menu display (SEQ/TrkEdit) is up.
- 2 Press [F6] (Menu) to select Menu 2, then press [F5] (Extract) to call up the Extract display (SEQ/TrkEdit).

This display can also be called up by moving the cursor to "10 Extract" and pressing [ENTER] on the Track Edit Menu display (SEQ/TrkEdit). Or press the numeric keys [1] and [0], then [ENTER].

- 3 Move the cursor to the Source track and select the Phrase track or Pattern from which you want to extract data.
- 4 When assigning the editing area by measures, move the cursor to "Measure" and specify the measure number at which extraction is to start, then move the cursor to "for" to specify the measure length for extraction.

When using Locate positions, press [LOCATE], and move the cursor to "From" to select the Locate number from where you want to start extracting. Then move the cursor to "to" and select the Locate number where you want to end extraction.

- 5 Move the cursor to the Destination track and select the Phrase track(s) or Pattern into which the extracted data will be inserted.
- 6 Move the cursor to "Mode" to specify extraction method.
- 7 Move the cursor to "Status" to select the data for extraction.

If you select NOTE, P.AFT, C.C or PROG, move the cursor to "Range" and specify the area. For NOTE or P.AFT, you can specify the key range by pressing keys of the keyboard.

- 8 Move the cursor to "Channel" and select the MIDI channel from which you want to extract data.
- 9 Press [F6] (Execute) to initiate extracting.

* Source and Destination parameters cannot be set to the same setting. If you execute the operation with the same setting, the display will show "Same Track or Pattern Selected." Select different Phrase tracks or Patterns and execute the operation again.

Shifting sequencer data backward or forward – 11 Shift Clock

This function shifts the timing of sequencer data backward or forward in time within a specified area in steps of 1 clock. Slight shifts of timing can speed up or drag performance.

- * When this function is executed, data that would be moved to a point before the beginning of the song will automatically shift to the beginning of the song. If data would be moved to a point past the end of the song, additional new measures will be created automatically as needed. The time signature of the newly created measures will be the same as that of the measure immediately preceding.

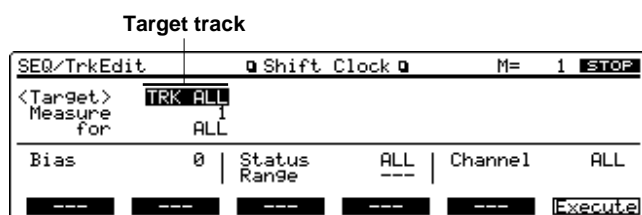

Target track

Selects the track(s) or Pattern(s) in which data will be shifted in time.

TRK ALL: Phrase tracks 1–16 and the Tempo track

TRK 1–TRK 16: The specified Phrase track

TRK T: The Tempo track

PTN 001–PTN 100: The specified Pattern

Measure (From), for (to) (Editing area)

Specifies the area of measures to be shifted in time.

Bias

Specifies the number of clocks for shifting the data in time.

Status

Selects the type of data to be shifted in time.

ALL: All types of sequencer data

NOTE: Note

P.AFT: Polyphonic Aftertouch

C.C: Controller numbers

PROG: Program numbers

C.AFT: Channel Aftertouch

BEND: Pitch Bend

EXC: System Exclusive messages

TUNE: Tune Request

PTN: Pattern Call messages

- * If the Target parameter is set to TRK T, the Status parameter will not be available.

Range

If you have selected NOTE, P.AFT, C.C or PROG for the Status parameter, use this parameter to specify the area.

To shift the timing of all Note or Polyphonic Aftertouch data, specify “C-1–G9.” To shift the timing of C4 Note/Polyphonic Aftertouch data, specify “C4–C4.” To shift the timing of Note/Polyphonic Aftertouch data from C3 to C4, specify “C3–C4.” This parameter can also be specified by pressing keyboard keys.

To shift the timing of all Controller numbers or Program numbers, specify “0–127.” To shift the timing of number 4, specify “4–4.” To shift the timing of numbers from 3 to 14, specify “3–14.”

Channel (MIDI channel)

Selects the MIDI channel of the data to be shifted in time.

To shift clocks of all sequencer data, set this parameter to ALL. To shift the sequencer data clock of just one specific MIDI channel, select that MIDI channel.

- * If you set the Target parameter to TRK T, or if the Status parameter is set to EXC, TUNE or PTN, the Channel parameter will not be available.

<Procedure>

- 1 Make sure that the Track Edit Menu display (SEQ/TrkEdit) is up.
- 2 Press [F6] (Menu) to select Menu 3, then press [F1] (Shift) to call up the Shift Clock display (SEQ/TrkEdit).

This display can also be called up by moving the cursor to “11 Shift” and pressing [ENTER] on the Track Edit Menu display (SEQ/TrkEdit). Or press the numeric key [1] twice and press [ENTER].

- 3 Move the cursor to Target track and select the track(s) or Pattern in which you want to shift data timing.
- 4 When assigning the editing area by measures, move the cursor to “Measure” and specify the measure number at which time shift starts, and move the cursor to “for” to specify the measure length to be shifted in time.

When using Locate positions, press [LOCATE], and move the cursor to “From” to select the Locate number from which data time shift is to start. Then move the cursor to “to” and select the Locate number where you want to end time shift.

- 5 Move the cursor to “Bias” and set the number of clocks to time shift data.
- 6 Move the cursor to “Status” to select the data to be time shifted.

If you select NOTE, P.AFT, C.C or PROG, move the cursor to “Range” and specify the area. For NOTE or P.AFT, you can specify the key range by pressing keys of the keyboard.

- 7 Move the cursor to “Channel” and select the MIDI channel of the data you want to time shift.
- 8 Press [F6] (Execute) to time shift data.

Thinning out sequencer data – 12 Data Thin

Continuously variable controllers such as aftertouch, pitch bend, and expression tend to create unexpectedly large amounts of data when operated. Data Thin will strip out redundant data to increase the amount of memory available for the sequencer.

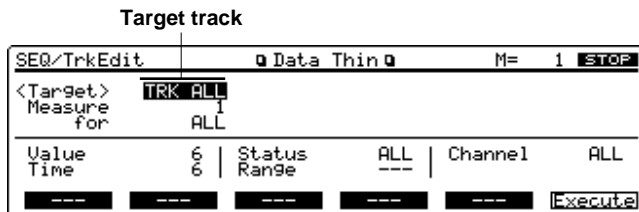

* Tempo changes and the way data changes will determine how much data can be thinned out before it has a degrading effect, so a general rule is hard to state. Try various different settings.

Target track

Selects the track(s) or Pattern(s) in which data will be thinned.

TRK ALL: Phrase tracks 1–16 and the Tempo track

TRK 1–TRK 16: The specified Phrase track

PTN 001–PTN 100: The specified Pattern

Measure (From), for (to) (Editing area)

Specifies the area of measures in which data will be thinned.

Value

For thinning data which incorporates rapid changes, use higher settings. If you don't want to thin that much data even though it is subject to rapid change, use lower settings.

Time

If you are thinning data that changes gradually over time, use higher settings. If you don't want to thin that much data even though the changes are gradual, use lower settings.

Status

Selects the type of data to be thinned.

ALL: All following sequencer data types

P.AFT: Polyphonic Aftertouch

C.C: Controller numbers

C.AFT: Channel Aftertouch

BEND: Pitch Bend

Range

If P.AFT or C.C is selected for the Status parameter, use this parameter to specify the area.

To thin all Polyphonic Aftertouch data, set "C-1–G9." To thin C4 Polyphonic Aftertouch data, set "C4–C4." To thin Polyphonic Aftertouch data from C3 to C4, set "C3–C4."

To thin all Controller numbers, set "0–127." To thin number 4, set "4–4." To thin numbers from 3 to 14, set "3–14."

Channel (MIDI channel)

Selects MIDI channel of the data to be thinned. To thin all sequencer data, set this parameter to ALL. To thin sequencer data of just one specific MIDI channel, select that MIDI channel.

<Procedure>

- ① Make sure that the Track Edit Menu display (SEQ/TrkEdit) is up.
- ② Press [F6] (Menu) to select Menu 3, then press [F2] (Thin) to call up the Data Thin display (SEQ/TrkEdit).

This display can also be called up by moving the cursor to "12 Data Thin" and pressing [ENTER] on the Track Edit Menu display (SEQ/TrkEdit). Or press the numeric keys [1] and [2], then [ENTER].

- ③ Move the cursor to Target track and select the track(s) or Pattern containing data you want to thin.
- ④ When assigning the editing area by measures, move the cursor to "Measure" and specify the measure number at which thinning will begin, then move the cursor to "for" to specify measure length to be thinned.

When using Locate positions, press [LOCATE], and move the cursor to "From" to select the Locate number where thinning is to start. Move the cursor to "to" and select the Locate number where thinning is to end.

- ⑤ Move the cursor to "Value" and specify the amount of data you want to thin.
- ⑥ Move the cursor to "Time" and set the time interval at which data will be thinned.
- ⑦ Move the cursor to "Status" to select the data to be thinned.

If you select P.AFT or C.C, move the cursor to "Range" and specify the area. For P.AFT, you can specify the key range by pressing keys of the keyboard.

- ⑧ Move the cursor to "Channel" and select the MIDI channel of data to be thinned.
- ⑨ Press [F6] (Execute) to thin out data.

Exchanging Phrase tracks/Patterns – 13 Exchange

This function exchanges the entire sequencer data between two Phrase tracks of Patterns.



Target track

Selects the two Phrase tracks or Patterns whose data is to be exchanged.

<Procedure>

- ❶ Make sure that the Track Edit Menu display (SEQ/TrkEdit) is up.
- ❷ Press [F6] (Menu) to select Menu 3, then press [F3] (Exchg) to call up the Exchange display (SEQ/TrkEdit).

This display can also be called up by moving the cursor to “13 Exchange” and pressing [ENTER] on the Track Edit Menu display (SEQ/TrkEdit). Or press the numeric keys [1] and [3], then [ENTER].

- ❸ Move the cursor to Target track and select the two Phrase tracks or Patterns whose data you want to exchange.
 - ❹ Press [F6] (Execute) to exchange data.
- * Both Target tracks cannot have the same setting. If you execute the operation with the same setting, the display will read “Same Track or Pattern Selected.” Select two different Phrase tracks or Patterns and execute the operation again.

Adjusting the song playback time – 14 Time Fit

This function calculates the playback time of a song or allows you to modify the Tempo track data so that the song will play back in a specified time.



Measure (From), for (to) (Editing area)

Specifies the area of measures for playback time to be calculated, or for which the Tempo track data will be modified.

Time

The playback time for the area specified by the Target parameter is indicated in parentheses (). Set a new playback time for the specified area in the section to the right of the arrow.

<Procedure>

- ❶ Make sure that the Track Edit Menu display (SEQ/TrkEdit) is up.
- ❷ Press [F6] (Menu) to select Menu 3, then press [F4] (TimeFit) to call up the Time Fit display (SEQ/TrkEdit).

You can also call up this display by moving the cursor to “14 Time Fit” and pressing [ENTER] on the Track Edit Menu display (SEQ/TrkEdit). Or press the numeric keys [1] and [4], then [ENTER].

- ❸ When assigning the editing area by measures, move the cursor to “Measure” and specify the measure number where time fit is to start. Move the cursor to “for” to specify the measure length which time fit is to work on.

When using Locate positions, press [LOCATE], and move the cursor to “From” to select the Locate number where time fit is to begin. Move the cursor to “to” and select the Locate number where time fit is to end.

- ❹ Move the cursor to “Time” and specify the playback time for the area specified by the Target parameter.
- ❺ Press [F6] (Execute) to execute time fit.

Deleting blank measures – 15 Truncate

Copying or merging may sometimes create blank measures at the beginning of a Phrase track or Pattern. Truncate deletes the 'silent' portion from the beginning of a specified Phrase track or Pattern until the first note-on.

- * If Program Change, Control Change, or other data except Note is contained in the section from the beginning of the specified Phrase track or Pattern until the first note-on, only the last event of each data type will be put before the note-on.

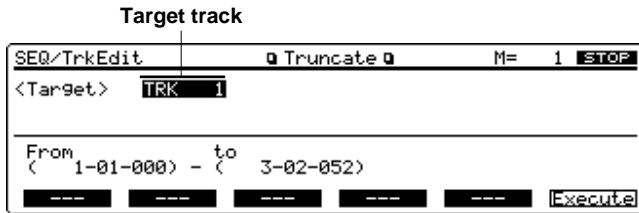

Target track

Selects the track or Pattern from which blank measures are to be truncated.

TRK 1–TRK 16: The specified Phrase track

PTN 001–PTN 100: The specified Pattern

From, to (Deleting area)

The display will show the beginning position of the Phrase track or Pattern specified by the Target track parameter (From) and the position of the first note-on (to).

<Procedure>

- 1 Make sure that the Track Edit Menu display (SEQ/TrkEdit) is up.
- 2 Press [F6] (Menu) to select Menu 3, then press [F5] (Truncate) to call up the Truncate leading Blank display (SEQ/TrkEdit).

You can also call up this display by moving the cursor to “15 Truncate” and pressing [ENTER] on the Track Edit Menu display (SEQ/TrkEdit). Or press the numeric keys [1] and [5], then [ENTER].

- 3 Select the Phrase track or Pattern that is to be truncated.
- 4 The area to be deleted will be displayed in “From” and “to.”
- * A short search time may be required to locate the silent section in the specified Phrase track or Pattern.
- 5 Press [F6] (Execute) to truncate.

Aligning a song's timing (Quantize)

Recording Quantize (quantization applied during realtime recording) was discussed in chapter 4, but the XP-80 can also quantize prerecorded song data.

The XP-80 has a Preview function that allows playing back the results of a Quantize operation while you are still setting parameters (before actual execution). This helps to make optimal Quantize settings.

- * Quantization adjusts only the timing at which notes are pressed and released, and has no effect on the timing of other data. This means that if you record MIDI messages such as bend range or modulation along with notes, quantization can cause the notes to go out of sync with the MIDI messages, skewing timing. To avoid such problems it is better to record non-keyboard data afterward, using mix recording, etc.

About quantizing

There are three quantization types available.

Grid quantize

Grid Quantize moves notes to (or toward) the nearest interval of the specified note value.

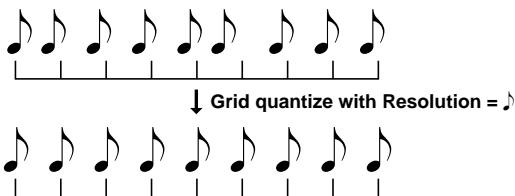

Shuffle quantize

Shuffle Quantize adds a 'swing' feel to the song.

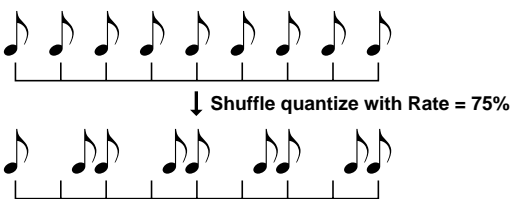

Groove quantize

Groove Quantize lets you use templates to apply different rhythmic 'feels' to your song.

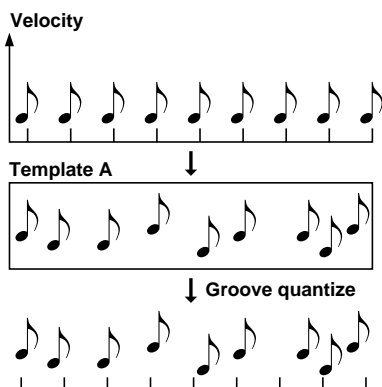

(Basic Procedure)

- 1 Make sure that the Play display (SEQ(Song)) is up.
- 2 Move the cursor to the song number and select the song to be quantized.
- 3 Press [F2] (Quantiz).
- * If you have selected a song saved on disk in step 2, a window asks "This Song is not Internal Song. Load anyway?" If you want to erase the song from internal memory and load the new song, press [F5] (OK). If you decide not to erase the song from the internal memory, press [F6] (Cancel).
- 4 Press any of [F1] (Grid), [F2] (Shuffle) and [F3] (Groove) to choose quantization type.
- 5 Set the parameters for the Quantize type you've selected.
- 6 Select the area to be quantized with the <Target> section (display right half).

For Quantize settings, you can specify whether you want each Phrase track quantized or not. To choose Phrase tracks to be quantized, press TRACK/PART [1]-[16] to light the button indicators. If you wish to quantize only one Phrase track, hold down [SHIFT] and press the corresponding TRACK/PART [1]]-[16] button. If you press this button combination again, all Phrase tracks will be selected for quantization. To select a Pattern to be quantized, press [PATTERN] then specify the Pattern number.

You can specify the quantization area using the same procedure as when specifying track editing area.

- * Once you set a Target, the setting will be also used for the next quantization assignment.
- * If you execute the operation without specifying the Phrase track to be quantized, the error message, "No Track Selected" will appear. Select a Phrase track and execute the operation again.
- 7 Press [F6] (Execute) to perform quantization.
- * To interrupt operation, press [EXIT].

After the operation is completed, the display will read "COMPLETE."

- * If you don't like the quantization results, you can restore settings to their pre-quantized state by pressing [UNDO/REDO].
- 8 To return to the Play display (SEQ(Song)), press [EXIT].

.....
<Preview function>

The Preview function allows you to hear how quantizing will work while you are still setting Quantize parameters (before you execute operation). If you modify parameter values during preview playback, the next preview playback will include those latest value changes. Try various parameter settings to find the one that works best.

- * Pattern Call events assigned to a Phrase track or muted Phrase tracks cannot be previewed.

<Procedure>

- 1 Make sure that you're making quantize parameter settings.
- 2 Move the cursor to "M" and specify the preview playback start position.

With Grid Quantize or Shuffle Quantize, the two measures starting from the current measure will play back repeatedly. With Groove Quantize, four measures will play back repeatedly.

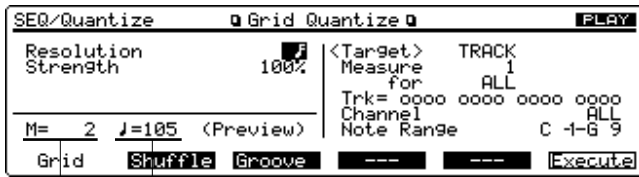

Measure Tempo

- * It is not possible to preview an area that does not contain note data.
 - ③ Press [STOP/PLAY] to start preview.
- The display will show “Preview” next to \downarrow , indicating that the preview mode is active.
- ④ Modify parameter values while listening to the preview playback and select optimum settings. The following parameters can be modified while using the Preview function.

Grid Quantize: Resolution, Strength

Shuffle Quantize: Resolution, Rate

Groove Quantize: Template Number, Timing Strength, Velocity Strength

- * Tempo can also be changed while using the Preview function, but this only changes playback tempo for the song. To retain this tempo setting, save the song again.
- ⑤ To stop preview playback, press [STOP/PLAY]. To perform Quantize, press [F6] (Execute).
- * You can also hold down [SHIFT] and press [STOP/PLAY] to play back in the normal way. This is convenient when comparing the song pre and post quantization.

Grid quantize

Similar to how Recording Quantize works, Grid Quantize can also be used on a prerecorded song. Grid Quantize moves notes to (or toward) the nearest interval of the specified note value, and can be applied to bass or drums which require that each note is precisely on the desired beat.

Target track

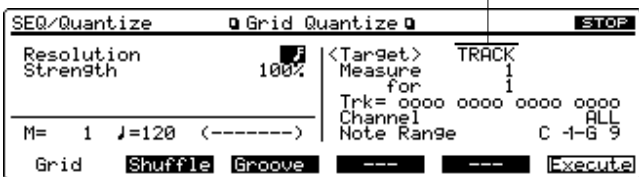

Resolution

Specifies quantization time interval as a note value.

Choose a Resolution that matches the smallest note in the area you’re quantizing.

Strength

This parameter specifies a percentage of how note timing will be corrected toward the timing interval that is specified by the Resolution parameter. With a setting of 100%, the note will move all the way to the nearest timing interval of the Resolution setting. A setting of 0% will not change note timing at all. Therefore values less than 100% make the note move less toward the nearest timing interval.

Target track

Specifies Phrase track(s) or Pattern to be quantized.

TRACK: The specified Phrase track(s)

A “o” symbol on the graphic display indicates the Phrase tracks to be quantized, and a “-” symbol shows Phrase tracks which won’t be quantized.

PTN001–100: The specified Pattern 1–100

Measure (From), for (to) (Editing area)

Specifies the area of measures to be quantized.

Channel (MIDI channel)

Specifies the MIDI channel(s) of the notes to be quantized. If you wish to quantize all notes, set this parameter to ALL. When quantizing only the notes of a specific MIDI channel, select that channel.

Note Range

Specifies the range of note numbers to be quantized.

<Procedure>

- ① On the Play display (SEQ(Song)), press [F2] (Quantiz).
- ② Press [F1] (Grid) to call up the Grid Quantize display (SEQ/Quantize).
- ③ Move the cursor to “Resolution” and set the quantization time interval.
- ④ Move the cursor to “Strength” and set quantization degree.
- ⑤ Move the cursor to Target track and select the Phrase track or Pattern that you want to quantize.

To select a Phrase track, press a TRACK/PART [1]–[16] button to make the button indicator light.

To select a Pattern, press [PATTERN] and specify the Pattern number.

- ⑥ When assigning the quantization area using measures, move the cursor to “Measure” and specify the measure number at which quantization is to begin, then move the cursor to “for” to specify the measure length to be quantized.

When using Locate positions, press [LOCATE], and move the cursor to “From” to select the Locate position number where quantization is to start. Move the cursor to “to” and select the Locate position number where quantization is to end.

- ⑦ Move the cursor to “Channel” and select the MIDI channel of notes to be quantized.
- ⑧ Move the cursor to “Note Range” and specify the range of note numbers to be quantized.

You can also specify the key range by pressing keys on the keyboard of the XP-60/XP-80.

- ⑨ Press [F6] (Execute) to perform Grid quantization.

Shuffle quantize

In the same way as Recording Quantize, you can also apply Shuffle Quantize to a prerecorded song to give it more of a 'swing' feel.

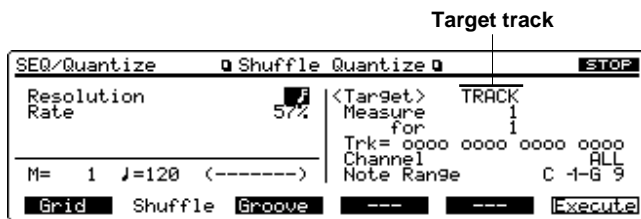

Resolution

Specifies quantization time interval as a note value. Select 8th or 16th notes.

Rate

This specifies how far apart you want a down-beat specified by the Resolution parameter to be from the up-beat that immediately follows. By shifting the timing of an up-beat, you can create a "swing" feel. A setting of 50% will place the timing of the up-beat note at the exact mid point between the down-beat and the next down-beat. A setting of 0% will move the up-beat note to the same timing as the previous down-beat. A setting of 100% will move it to the same timing as the following down-beat.

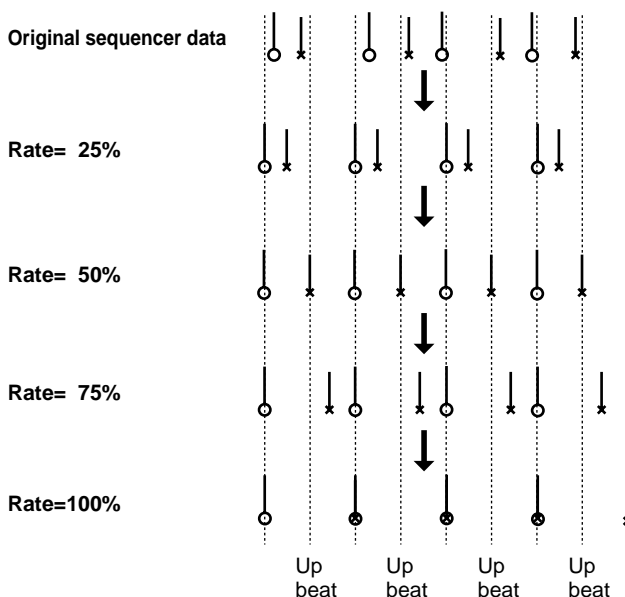

Target track

Specifies Phrase track(s) or Pattern to be quantized.

TRACK: The specified Phrase track(s)

A "o" symbol on the graphic display indicates Phrase tracks which are to be quantized, and a "-" symbol shows Phrase tracks which will not be quantized.

PTN001-100: The specified Pattern 1-100

Measure (From), for (to) (Editing area)

Specifies the area of measures to be quantized.

Channel (MIDI channel)

Specifies the MIDI channel(s) of the notes to be quantized. To quantize all notes, set this parameter to ALL. When quantizing only the notes of a specific MIDI channel, select that channel.

Note Range

Specifies the range of note numbers to be quantized.

<Procedure>

- ① On the Play display (SEQ(Song)), press [F2] (Quantiz).
- ② Press [F2] (Shuffle) to call up the Shuffle Quantize display (SEQ/Quantize).
- ③ Move the cursor to "Resolution" and set quantization time interval.
- ④ Move the cursor to "Rate" and specify how far apart an up-beat will be from the down-beat specified by the Resolution parameter.
- ⑤ Move the cursor to Target track and select the Phrase track or Pattern that you want to quantize.

To select a Phrase track, press a TRACK/PART [1]-[16] button to make the button indicator light.

To select a Pattern, press [PATTERN] and specify the Pattern number.

- ⑥ When assigning the quantization area by measures, move the cursor to "Measure" and specify the measure number at which quantization will begin, then move the cursor to "for" to specify the measure length to be quantized.

When using Locate positions, press [LOCATE], and move the cursor to "From" to select the Locate position number from where quantization is to start. Move the cursor to "to" and select the Locate position number where you want to stop quantization.

- ⑦ Move the cursor to "Channel" and select the MIDI channel of notes to be quantized.
- ⑧ Move the cursor to "Note Range" and specify the range of note numbers to be quantized.

You can also specify key range by pressing keys on the keyboard.

- ⑨ Press [F6] (Execute) to perform Shuffle quantization.

Groove quantize

The XP-80 provides 71 quantize templates. These templates contain various quantize settings for applying rhythmic 'feels' of many different musical categories. Select the template you want for quantization.

You can also create your own templates and store up to 16 of them in the XP-80's internal memory. This lets you incorporate the 'feel' of your favorite songs right away.

- * If your sequencer data notes are too far off from accurate time, Groove Quantize may not work that efficiently so you won't achieve the desired results. If this is the case, apply Grid Quantize to your sequencer data first to lose timing mistakes.

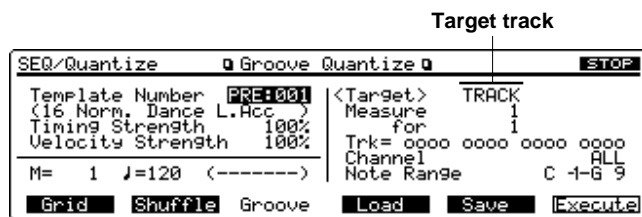

Template (Template number)

Specifies the template you wish to use. PRE:001–071 represent the 71 templates the XP-80 provides, and USR:001–016 represent user groove templates, if you've created them. The template name you pick will be shown in parentheses ().

- * At power on or before loading a user groove template, USR:001–016 are Initial Templates (factory default settings). If you select any of the Initial Templates USR:001–016 and perform Groove quantization, it will have no effect.

Here is a list of preset groove templates.

- PRE:001: Dance (small dynamics)
- PRE:002: Dance (large dynamics)
- PRE:003: Dance (light swing)
- PRE:004: Dance (heavy swing)
- PRE:005: Dance (dragging beats, small dynamics)
- PRE:006: Dance (dragging beats, large dynamics)
- PRE:007: Dance (dragging beats, light swing)
- PRE:008: Dance (dragging beats, heavy swing)
- PRE:009: Dance (pushing beats, small dynamics)
- PRE:010: Dance (pushing beats, large dynamics)
- PRE:011: Dance (pushing beats, light swing)
- PRE:012: Dance (pushing beats, heavy swing)
- PRE:013: Fusion (small dynamics)
- PRE:014: Fusion (large dynamics)
- PRE:015: Fusion (light swing)
- PRE:016: Fusion (heavy swing)
- PRE:017: Fusion (dragging beats, small dynamics)
- PRE:018: Fusion (dragging beats, large dynamics)
- PRE:019: Fusion (dragging beats, light swing)
- PRE:020: Fusion (dragging beats, heavy swing)
- PRE:021: Fusion (pushing beats, small dynamics)
- PRE:022: Fusion (pushing beats, large dynamics)
- PRE:023: Fusion (pushing beats, light swing)
- PRE:024: Fusion (pushing beats, heavy swing)

- PRE:025: Reggae (small dynamics)
- PRE:026: Reggae (large dynamics)
- PRE:027: Reggae (light swing)
- PRE:028: Reggae (heavy swing)
- PRE:029: Reggae (dragging beats, small dynamics)
- PRE:030: Reggae (dragging beats, large dynamics)
- PRE:031: Reggae (dragging beats, light swing)
- PRE:032: Reggae (dragging beats, heavy swing)
- PRE:033: Reggae (pushing beats, small dynamics)
- PRE:034: Reggae (pushing beats, large dynamics)
- PRE:035: Reggae (pushing beats, light swing)
- PRE:036: Reggae (pushing beats, heavy swing)
- PRE:037: Pops (small dynamics)
- PRE:038: Pops (large dynamics)
- PRE:039: Pops (light swing)
- PRE:040: Pops (heavy swing)
- PRE:041: Pops (dragging beats, small dynamics)
- PRE:042: Pops (dragging beats, large dynamics)
- PRE:043: Pops (dragging beats, light swing)
- PRE:044: Pops (dragging beats, heavy swing)
- PRE:045: Pops (pushing beats, small dynamics)
- PRE:046: Pops (pushing beats, large dynamics)
- PRE:047: Pops (pushing beats, light swing)
- PRE:048: Pops (pushing beats, heavy swing)
- PRE:049: Rhumba (small dynamics)
- PRE:050: Rhumba (large dynamics)
- PRE:051: Rhumba (light swing)
- PRE:052: Rhumba (heavy swing)
- PRE:053: Rhumba (dragging beats, small dynamics)
- PRE:054: Rhumba (dragging beats, large dynamics)
- PRE:055: Rhumba (dragging beats, light swing)
- PRE:056: Rhumba (dragging beats, heavy swing)
- PRE:057: Rhumba (pushing beats, small dynamics)
- PRE:058: Rhumba (pushing beats, large dynamics)
- PRE:059: Rhumba (pushing beats, light swing)
- PRE:060: Rhumba (pushing beats, heavy swing)
- PRE:061: Samba (for Pandeiro, etc.)
- PRE:062: Samba (for Surdo, Timbale)
- PRE:063: Axe (for Caixa)
- PRE:064: Axe (for Surdo)
- PRE:065: Salsa (for Cascala)
- PRE:066: Salsa (for Conga)
- PRE:067: Triplets
- PRE:068: Quintuplets
- PRE:069: Sextuplets
- PRE:070: Septuplets over two beats
- PRE:071: Lagging triplets

- * The preset groove templates are provided for 4/4 time signature use. They may not produce desired results if used on other time signature data.

- * Preset templates are categorized just for reference; Feel free to experiment using different templates for different kinds of music, till you find one that works best with your music.

Timing Strength

This specifies how much a note will move toward the timing interval of the template you pick. At a setting of 100%, the note will be perfectly timed with the template. At a setting of 0%, the note will not move at all.

Velocity Strength

This parameter specifies how much a note will move toward the velocity of the template you choose. At a setting of 100%, the note's velocity will equal that of the template. At a setting of 50%, the note velocity will be a mid value between the template's velocity and the original performance's. A setting of 0% will have no effect on velocity.

Target track

Specifies Phrase track(s) or Pattern to be quantized.

TRACK: The specified Phrase track(s)

A "o" symbol on the graphic display indicates Phrase tracks which will be quantized, and a "-" symbol shows Phrase tracks which will not be quantized.

PTN001-100: The specified Pattern 1-100

Measure (From), for (to) (Editing area)

Specifies the area of measures to be quantized.

Channel (MIDI channel)

Specifies the MIDI channel(s) of the notes to be quantized. To quantize all notes, set this parameter to ALL. When quantizing only the notes of a specific MIDI channel, select that channel.

Note Range

Specifies the range of note numbers to be quantized.

<Procedure>

- ❶ On the Play display (SEQ(Song)), press [F2] (Quantiz).
- ❷ Press [F3] (Groove) to call up the Groove Quantize display (SEQ/Quantize).
- ❸ Move the cursor to "Template" and select the template you want.
- ❹ Move the cursor to "Timing Strength" and specify the percentage you want the note to move closer to the timing interval of the template.
- ❺ Move the cursor to "Velocity Strength" and specify the percentage you want the note to move closer to the velocity of the template.
- ❻ Move the cursor to Target track and select the Phrase track or Pattern that you want to quantize.

To select a track, press a TRACK/PART [1]-[16] button to light the indicator.

To select a Pattern, press [PATTERN] and specify the Pattern number.

- ❼ When assigning the quantization area by measures, move the cursor to "Measure" and specify the measure number at which quantization will begin. Move the cursor to "for" to specify the measure length to be quantized.

When using Locate positions, press [LOCATE], and move the cursor to "From" to select the Locate position number from where you want to start quantization. Then move the cursor to "to" and select the Locate position number where you want to stop quantization.

- ❽ Move the cursor to "Channel" and select the MIDI channel of notes to be quantized.
- ❾ Move the cursor to "Note Range" and specify the range of note numbers to be quantized.

You can also specify the key range by pressing keys on the keyboard.

- ❿ Press [F6] (Execute) to perform Groove quantization.

<Tips on using preset groove templates>

The preset groove templates are designed with a lot of attention to detail so that you will be able to achieve a perfect performance making use of Groove Quantize. Here are some tips on using the preset groove templates.

Use Groove Quantize with drums and bass performance

Drum and bass parts are the most important components that determine the music's rhythmic feel. With this in mind, the XP-80's preset groove templates are created to match these instruments. When applying Groove Quantize with other instruments, add less quantization for these instruments than for percussion instruments.

Correctly set the measure at which you start quantization

Preset templates consist of four measures. As each beat of the music has greater or lesser velocity, each measure has its own velocity. Accordingly, the XP-80's preset groove templates have such dynamics variations for its four measures. For instance, if you use Groove Quantize from the first measure of a song containing setup data in its first measure, and sequencer data from its second measure onward, your song will not sync with the template in time. To avoid this problem, you should start quantization from the second measure. Keep in mind the musical composition and melody line of your song when deciding on the measure from where you'll start applying Groove Quantize in order to get the perfect result.

Adjust tempo

The preset groove templates have been created with a reference tempo of about ♩ =120-140. When performing Groove Quantize with a song whose tempo is faster than the reference tempo, a Timing Strength parameter setting of 100% will work the best. For a slower tempo song, set the Timing Strength parameter to less than 100%.

Add an effective swing feel

For an effective swing feel, tempo is the key. For instance, when you are working with jazz rhythms, it will be effective to add more of a swing feel to slow-tempo songs; adding less swing to faster tempo songs will increase the feel of 'speed.' For dance rhythms, applying more swing to fast-tempo songs will give you a 'shuffle' feel.

Experiment until you find the best swing.

Use the Preset Template List for quick selection

Although the preset groove templates are grouped by musical categories, it's relatively hard to pick the most suitable from the 71 templates available.

The Preset Template List below will help you quickly select the template you want.

16Beat Dance

	Light Accent	Hard	Accent	Light Swing	Hard Swing	
Normal	001:16 Norm. Dance L.Acc		002:16 Norm. Dance H.Acc		003:16 Norm. Dance L.Swg	004:16 Norm. Dance H.Swg
Heavy	005:16 Heavy Dance L.Acc		006:16 Heavy Dance H.Acc		007:16 Heavy Dance L.Swg	008:16 Heavy Dance H.Swg
Pushed	009:16 Pushed Dance L.Acc		010:16 Pushed Dance H.Acc		011:16 Pushed Dance L.Swg	012:16 Pushed Dance H.Swg

16Beat Fusion

	Light Accent	Hard	Accent	Light Swing	Hard Swing	
Normal	013:16 Norm. Fusion L.Acc		014:16 Norm. Fusion H.Acc		015:16 Norm. Fusion L.Swg	016:16 Norm. Fusion H.Swg
Heavy	017:16 Heavy Fusion L.Acc		018:16 Heavy Fusion H.Acc		019:16 Heavy Fusion L.Swg	020:16 Heavy Fusion H.Swg
Pushed	021:16 Pushed Fusion L.Acc		022:16 Pushed Fusion H.Acc		023:16 Pushed Fusion L.Swg	024:16 Pushed Fusion H.Swg

16Beat Reggae

	Light Accent	Hard	Accent	Light Swing	Hard Swing	
Normal	025:16 Norm. Reggae L.Acc		026:16 Norm. Reggae H.Acc		027:16 Norm. Reggae L.Swg	028:16 Norm. Reggae H.Swg
Heavy	029:16 Heavy Reggae L.Acc		030:16 Heavy Reggae H.Acc		031:16 Heavy Reggae L.Swg	032:16 Heavy Reggae H.Swg
Pushed	033:16 Pushed Reggae L.Acc		034:16 Pushed Reggae H.Acc		035:16 Pushed Reggae L.Swg	036:16 Pushed Reggae H.Swg

8Beat Pops

	Light Accent	Hard	Accent	Light Swing	Hard Swing	
Normal	037: 8 Norm. Pops L.Acc		038: 8 Norm. Pops H.Acc		039: 8 Norm. Pops L.Swg	040: 8 Norm. Pops H.Swg
Heavy	041: 8 Heavy Pops L.Acc		042: 8 Heavy Pops H.Acc		043: 8 Heavy Pops L.Swg	044: 8 Heavy Pops H.Swg
Pushed	045: 8 Pushed Pops L.Acc		046: 8 Pushed Pops H.Acc		047: 8 Pushed Pops L.Swg	048: 8 Pushed Pops H.Swg

8Beat Rhumba

	Light Accent	Hard	Accent	Light Swing	Hard Swing	
Normal	049: 8 Norm. Rhumba L.Acc		050: 8 Norm. Rhumba H.Acc		051: 8 Norm. Rhumba L.Swg	052: 8 Norm. Rhumba H.Swg
Heavy	053: 8 Heavy Rhumba L.Acc		054: 8 Heavy Rhumba H.Acc		055: 8 Heavy Rhumba L.Swg	056: 8 Heavy Rhumba H.Swg
Pushed	057: 8 Pushed Rhumba L.Acc		058: 8 Pushed Rhumba H.Acc		059: 8 Pushed Rhumba L.Swg	060: 8 Pushed Rhumba H.Swg

Samba

061: Samba 1 (Pandero etc)
062: Samba 2 (Surdo/Timba)

Axe

063: Axe 1 (Caixa)
064: Axe 2 (Surdo)

Salsa

065: Salsa 1 (Cascala)
066: Salsa 2 (Conga)

Tuplets

067: Triplets
068: Quintuplets
069: Sextuplets
070: 7 Against 2 QuaterNo
071: Lagging Triplets

<Procedure>

❶ Select the musical category.

In 16-beat, Dance, Fusion and Reggae categories are provided and in 8-beat, Pops and Rhumba categories are available. Besides these, there are also Samba, Axe, Salsa and Tuplets.

❷ Select the feel you want on the vertical axis.

If you want a 'tight' performance choose Normal. For pushing beats select Pushed, and for dragging beats choose Heavy.

❸ Select the variation you want on the horizontal axis.

When adding less dynamics, choose Light Accent. For greater dynamics, choose Hard Accent. To swing lighter, select Light Swing, and for stronger swing, choose Hard Swing.

❹ The template at the intersection of the vertical and horizontal axes shows the one you want. Specify the template by using the numeric keys.

For example, if you want to play fusion with a dragging beat and light swing, you would select "16 Heavy Fusion L.Swg." "16 Heavy Fusion H.Swg." will be effective for jazzier playing and "8 Norm.Pops L.Acc." will be suitable for '70s pops.

* Samba, Axe, Salsa and Tuplets categories are not available with options for feel and variations.

Creating a user groove template

To apply the rhythmic ‘feel’ of your favorite song, you can create a user groove template containing that feel before performing Groove Quantize.

- * User templates should be created mainly for drums and bass, as the ‘feel’ of a song is primarily determined by the drum and bass. If you want, you can also create templates for other instruments as necessary.

<Procedure>

- 1 Load the song you want to use for a user groove template into the internal memory.
- 2 Select the four measures to be used for the user groove template and delete all other sections of the song.

User groove templates are created based on notes. Therefore, if the selected four measures only contain setup data or other non-note data, the resulting template will be blank for that portion.

If you select the beginning portion of a song, it is probably an intro so you may not obtain the desired result. Once you find the section of the song you like the most, you should select four measures, taking the velocity of each measure into consideration.

- 3 Insert a disk into the disk drive.
 - 4 Press [DISK] to call up the Disk Menu display (DISK).
 - 5 Press the numeric key [2], then [ENTER] to call up the Save display (Disk/Save).
 - 6 Move the cursor to “File Type” and select “SMF-0.”
- * Only the Standard MIDI File format 0 is usable with user groove templates.
 - 7 Move the cursor to the position where you want to input a character of “File Name.”
 - 8 Use [INC]/[DEC], numeric keys or the VALUE dial to input a character for the file name.

For naming the file in the Name window, press [F1] (Name).

To view the list of Standard MIDI Files on the disk, press [F5] (List). To select a file from the list, move the cursor to the desired file and press [F6] (Select) or [ENTER].

- 9 Repeat steps 7 and 8 to assign the name you want to the template file.
- * The file name you assign here will be saved on disk. The name displayed below the template number should be assigned on the Song Name display (SEQ/Setup). Up to 15 alphanumeric characters can be input so it’s useful to include information such as music genre or instruments which best suit the template.
- 10 Press [F6] (Execute) to create a user groove template.

The file name extension “.MID” appears.

Now a user groove template has been created.

- * If you try to save a file with a pre-existing name, a window asks “File Name duplicate. Overwrite?” To rewrite the file, press [F5] (OK). To cancel saving, press [F6] (Cancel).
- * When you try to save data to a disk which has not been formatted for the XP-80, a window asks “Unformatted disk. Format?” When formatting the disk, press [F5] (OK). If you decide not to format the disk, press [F6] (Cancel).

- 1 Press [DISK] to return to the original display.

<Editing a preset template>

For editing a preset template PRE:001–PRE:071 as you like, follow the procedure below:

To edit 16-beat templates (Axe, Salsa or others indicated 16 for the template name), set the Step Time parameter for step recording to and Velocity parameter to any value except 0. Now step-record appropriate notes for four measures. Similarly when editing an 8-beat template (those indicated 8 for the template name), set the Step Time parameter to then input data.

Next perform Groove Quantize for the input data using the selected template. For Groove Quantize, set the Timing Strength and Velocity Strength parameters to 100%.

Edit the data using the Track Edit or Microscope Edit functions, and save it to disk in the Standard MIDI File format 0.

Loading a user groove template

User templates should first be loaded into USR:001–016 before they are used.

- * After loading a user groove template into USR:001–016, if you turn the power off, the templates will default to factory settings (Initial Template). To keep the USR:001–016 settings you’ve loaded, save it to disk as a user groove template file (p.143).
- * If you load a Standard MIDI File format 0 song into any of USR:001–016, the first four measures from the song will automatically become a template. However, the first four measures of a song often contain setup data or intro, so the most appropriate template may not be possible. Create a user groove template by referring to the preceding section “Creating a user groove template.”

<Procedure>

- 1 Insert the disk into the disk drive.
- 2 Make sure that the Groove Quantize display (SEQ/Quantize) is up.
- 3 Press [F4] (Load) to call up the Load Groove Template display (SEQ/Load).



- 4 Move the cursor to “File Type” and select “SMF→GRV.”

With a SMF→GRV selection, a format 0 Standard MIDI File will be converted into a user groove template.

- 5 Press [▶] to move the cursor to “USER” and select the destination into which a user groove template will load from USR:001–016.
- 6 Move the cursor to “File Name” and select a user groove template.

To view the list of Standard MIDI Files on the disk, press [F5] (List). To select a user groove template from the list, move the cursor to the desired file and press [F6] (Select) or [ENTER].

- * The Standard MIDI File list displays format 0 as well as format 1 files. If you try to load a format 1 Standard MIDI File as a user groove template, a message "Cannot Read the Song/File" will appear.
- ⑦ Press [F6] (Execute) to load the user groove template.

Now, the user groove template has been loaded.

- ⑧ Press [EXIT] to return to the Groove Quantize display (SEQ/Quantize).

Perform Groove Quantize in the normal way.

Saving 16 user groove templates together to disk

The XP-80 allows you to save 16 user groove templates loaded into USER:001-016 to disk as a single file. This file is called a 'user groove template file.'

If you load a user groove template file into XP-80, all user groove templates in USER:001-016 will be replaced with new ones. It is more convenient to organize user groove templates according to the musical genre, etc.

<Procedure>

- ① Insert a disk into the disk drive.
- ② Make sure that the Groove Quantize display (SEQ/Quantize) is up.
- ③ Press [F5] (Save) to call up the Save Groove Template display (SEQ/Save).



The File Type parameter is set to Groove. This means that user groove templates USER:001-USER:016 will be saved to disk as user groove template files.

- ④ Press [◀] or [▶] to move the cursor to a position where you want to enter a character.
- ⑤ Use numeric keys, [INC]/[DEC] or the VALUE dial to input a character for the file name.

When you will be naming the file in the Name window, press [F1] (Name).

To view the list of user groove template files on the disk, press [F5] (List). To select a file from the list, move the cursor to the desired file and press [F6] (Select) or [ENTER].

- ⑥ Repeat steps 4 and 5 to assign a name you want to the template file.
- ⑦ Press [F6] (Execute) to save the file.

The file name extension ".SVT" appears.

- * If you try to save a file with a pre-existing name, a window asks "File Name duplicate. Overwrite?" To rewrite the file, press [F5] (OK). To cancel saving, press [F6] (Cancel).

- * When you try to save data to a disk which has not been

formatted for the XP-80, a window asks "Unformatted disk. Format?" When formatting the disk, press [F5] (OK). If you decide not to format the disk, press [F6] (Cancel).

- ⑧ Press [EXIT] to return to the Groove Quantize display (SEQ/Quantize).

Loading a user groove template file

If you load a user groove template file into the XP-80, all the user groove templates in USER:001-016 will be replaced with the new ones.

<Procedure>

- ① Insert the disk to the disk drive.
- ② Make sure that the Groove Quantize display (SEQ/Quantize) is up.
- ③ Press [F4] (Load) to call up the Load Groove Template display (SEQ/Quantize/Load).
- ④ Move the cursor to "File Type" and select "GROOVE."
- ⑤ Move the cursor to "File Name" and select a user groove template file .

To view the list of user groove template files on the disk, press [F5] (List). To select a user groove template file from the list, move the cursor to the desired file and press [F6] (Select) or [ENTER].

To view the list of Standard MIDI Files, press [F2] (SMF).

- ⑥ Press [F6] (Execute) to load the user groove template file.

When the user groove template file has been loaded, the Groove Quantize display (SEQ/Quantize) will automatically appear.

Editing sequencer data one at a time (Microscope Edit)

Microscope Edit allows you to modify individual MIDI messages, tempo data and other minute sequencer data recorded on a song.

Viewing the Microscope display

On the Microscope display (SEQ/Micro), you can confirm recorded sequencer data one at a time. For Microscope editing, call up this display.

Song position (measure-beat-clock)		Sequencer data		Phrase track/Pattern	
SEQ/Micro	Microscope	Track 1			
1-01-000>	Sys.Excl	F0:7E	7F	09	02:F7
010	Sys.Excl	F0:41	10	6A	12 00 00 00>
015	Sys.Excl	F0:41	10	6A	12 00 00 00>
059	Sys.Excl	F0:41	10	6A	12 01 00 00>
070	Sys.Excl	F0:41	10	6A	12 01 00 10>
081	Sys.Excl	F0:41	10	6A	12 01 00 11>

Create Erase Move Copy Place View

Each line shows the Song position (measure-beat-clock) at which sequencer data is recorded and the data type. To use screen space effectively, Song position without sequencer data will not normally be displayed. A "*" symbol at the left of the sequencer data shows other data exists at the same Song position.

* For details regarding each sequencer data, refer to "Sequencer data handled by Phrase tracks/Patterns," "Data handled by the Tempo track," and "Data handled by the Beat track."

<Procedure>

- 1 Make sure that the Play display (SEQ(Song)) is up.
 - 2 Move the cursor to the song number and select the song for which the Microscope display (SEQ/Micro) will be displayed.
 - 3 Press [F4] (Micro) to call up the Microscope display (SEQ/Micro).
- * If you have selected a song saved on disk in step 2, a window asks "This Song is not Internal Song. Load anyway?" If you want to erase the song from the internal memory and load the new song, press [F5] (OK). If you decide not to erase the song from the internal memory, press [F6] (Cancel).
- 4 Select the track or Pattern you wish to view.

If you wish to select a Phrase track, press TRACK/PART [1]-[16].

If you wish to select a Pattern, press [PATTERN] to open the Pattern Select window and specify the Pattern number.

When selecting the Tempo track or Beat track, press [TEMPO/BEAT]. Each time [TEMPO/BEAT] is pressed, the selection will cycle through the Tempo track, Beat track, and Phrase track, back to the Tempo track, and so on.

- 5 Press [▲] or [▼] to move ">" up and down to view the recorded sequencer data successively.

When the cursor has been moved to the Clock, you can also move through the data by pressing [INC]/[DEC] or turning the VALUE dial.

If you wish to move ">" in steps of a measure, move the cursor to the measure and press [INC]/[DEC] or turn the VALUE dial. You can also move in steps of a measure by pressing [BWD]/[FWD].

If you wish to move ">" in steps of one beat, move the cursor to the beat and press [INC]/[DEC] or turn the VALUE dial.

- 6 To return to the Play display (SEQ(Song)), press [EXIT]. Pressing [EXIT] when a Pattern's Microscope display (SEQ/Micro) is up will return to the Play display (SEQ(Pattern)). In that case, press [EXIT] again to return to the Play display (SEQ(Song)).

<Transmitting MIDI messages (Test Out)>

Test Out transmits data for which ">" is displayed from MIDI OUT connector. This is useful when checking chords.

<Procedure>

- 1 Make sure that the Microscope display (SEQ/Micro) is up.
- 2 Move ">" to the data which you want to perform Test Out with.
- 3 Press [ENTER].

That data will be transmitted from the MIDI OUT connector. For Note messages, notes will continue to sound as long as [ENTER] is held down. When you release [ENTER], the Note-off message will be transmitted.

Sequencer data handled by Phrase tracks/Patterns

A Phrase track or Pattern contains the following nine types of sequencer data. Each has various parameters.

- * Parameter names (OnV, OfV, etc.) will be shown for the data with ">." Display of parameter names will be omitted for other data, and only values will be shown.

Note

This MIDI message is recorded each time you press a key or release a key. Note name will be shown in parentheses ().

		Note number			
MIDI channel	Note (note name)	On velocity	Gate time	Off velocity	
1-01-000	16 Note(C#4)	61	OnV=127	Gt=65535	OfV=64

OnV (On velocity): Force you press a key with

Gt (Gate time): Time from key press to key release (note length)

OfV (Off velocity): Force you release a key with

Poly Aft (Polyphonic aftertouch)

This MIDI messages applies aftertouch to each note. The note name will be shown in parentheses ().

		Polyphonic aftertouch		
MIDI channel	(note name)	Note number	Value	
1-01-000	16 Poly Aft(C#4)	Note=	61	Val=127

Ctrl Change (Control change)

This MIDI message applies modulation, expression or other effects corresponding to each Controller number.

* For functions corresponding to each Controller number, see "MIDI Implementation" (p.214).

MIDI channel	Control change	Controller number (Function name)	Value
1-01-000	16	Ctrl Change CC#=1 (Modulation)	127

CC# (Controller number): The function name corresponding to each Controller number will be displayed within parentheses ().

Prog Change (Program change)

This MIDI message changes the instrument sound.

MIDI channel	Program change	Program number
1-01-000	16	Prog Change PC#=64

Channel Aft (Channel aftertouch)

This MIDI message applies aftertouch to each MIDI channel.

MIDI channel	Channel aftertouch	Value
1-01-000	16	Channel Aft Val=64

Pitch Bend

This MIDI message modifies pitch.

MIDI channel	Pitch bend	Value
1-01-000	16	Pitch Bend Val=+8191

Tune (Tune request)

This MIDI message tunes an analog synthesizer.

MIDI channel	Tune request
1-01-000	Tune

Pattern (Pattern Call message)

This message commands a Pattern to play back. The Song position next to the end of the Pattern will be displayed in parentheses ().

MIDI channel	Pattern call message	Pattern number
1-01-000	Pattern	Num=001 (->1-01-000)

Sys.Excl (System exclusive message)

This message is commonly used for all connected MIDI devices in a system. If a System Exclusive message is too long to be displayed on a single line, ">" will appear at screen right.

MIDI channel	System exclusive message	Data
1-01-000	Sys.Excl	F0:41 10 6A 12 00 00 00>

System Exclusive message: F0:... (hex number)... :F7

Data handled by the Tempo track

The Tempo track contains tempo change data of a song.

Tempo Change

Determines the tempo of a song. The song will play back using this Tempo Change value.

The displayed (♩ =) value is the tempo at which the song actually plays back (playback tempo) and can be modified only on the Play display (SEQ).

If the Tempo Change value differs from the playback tempo, it shows that playback tempo has been modified temporarily. As the Tempo Change value has not yet been rewritten, this temporary setting will be lost if another song is selected or power off. If you wish to use the same tempo when playing back the song for the next time, save the song again to disk. This will rewrite the Tempo Change value so that it will equal the playback tempo.

MIDI channel	Tempo change	Tempo change value	Playback tempo
1-01-000	Tempo Change	Value=120	(♩=120)

Value: Tempo Change

Data handled by the Beat track

The Beat track contains the beat change data and the key signature which determines whether black keys will be displayed as sharps (#) or flats (b).

Beat Change

Determines the time signature.

MIDI channel	Beat change	Beat
1-01-000	Beat Change	Beat=4/4

Key Signature

This changes how black keys will be displayed and does not effect song recording method.

MIDI channel	Key signature	Scale	Key (Number of sharps or flats on staff notation)
1-01-000	Key Signature	Scale=MAJOR	C#(#####)

Viewing only specific sequencer data

Phrase tracks or Patterns contain much sequencer data, and so are difficult to view on the display. To effectively cope with this, you can select the data types to appear on the display. By limiting the display to show just the type of MIDI message you're interested in, you'll be able to find the MIDI message more efficiently.

<Procedure>

- ❶ Make sure that the Microscope display (SEQ/Micro) is up.
- ❷ Press [F6] (View) to call up the View Select display (SEQ/Micro).

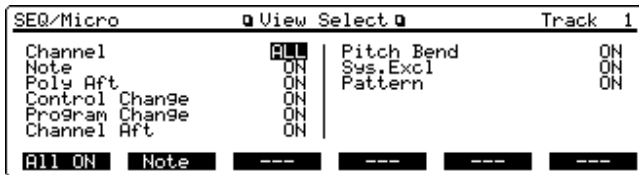

- ❸ Move the cursor to “Channel” and select the MIDI channel whose data you wish to view.

To view sequencer data of all MIDI channels, set this parameter to ALL. To view the data of a specific MIDI channel, specify that channel using numbers 1–16.

- ❹ Move the cursor to each type of data and set it ON (when viewing that data) or OFF (when not viewing that data). To view all sequencer data, press [F1] (All On).

When viewing only Note messages, press [F2] (Note).

When you wish to view only one specific type of data, move the cursor to that data and press [F3].

- * When the cursor is at “Channel” or “Note,” it is not possible to press [F3].
- ❺ After you finish settings, press [EXIT] to return to the Microscope display (SEQ/Micro).

Modifying sequencer data recorded in a Phrase track/Pattern

You can modify the parameters of sequencer data recorded in a Phrase track or Pattern. However message type cannot be changed, such as changing a Control Change message into a Pitch Bend message.

- * For details of sequencer data, refer to “Sequencer data handled by Phrase tracks/Patterns” (p.144).
- * Tune Request has no parameter so it cannot be modified.

<Procedure>

- ❶ Make sure that the Microscope display (SEQ/Micro) is up.
- ❷ Select the Phrase track or Pattern whose data you want to modify.

To select a Phrase track, press TRACK/PART [1]–[16].

To select a Pattern, press [PATTERN] to open the Pattern Select window and specify the Pattern number.

- ❸ Press [▲] or [▼] to move “>” to the data to be modified.
- ❹ Press [◀] or [▶] to move the cursor to the parameter to be modified, then specify the desired value.

- * The note number (note name) of the Note or Polyphonic Aftertouch data can be changed by pressing a key on the keyboard to specify the note number. You can also press a numeric key while holding down [SHIFT] to specify a note name (C–B) or an accidental mark (#, b).
- * To modify the OnV (On Velocity) or OfV (Off Velocity) value of the Note data, you can also press a key on the keyboard.
- * When modifying System Exclusive messages, the procedure is slightly different. Follow the procedure below:

<Modifying System Exclusive messages>

<Procedure>

- ❶ Press [▲] or [▼] to move “>” to the System Exclusive message to be modified.
- ❷ Press [▶] to move the cursor to the data to be modified.

The Sys.Excl Edit display (SEQ/Micro) will appear.

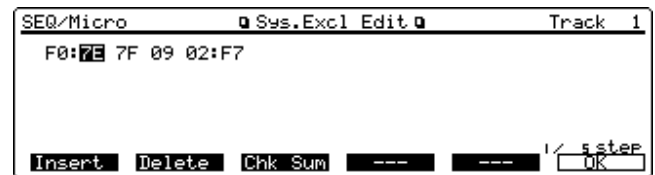

By holding down [SHIFT] while you press [◀], the cursor can be moved right back to the beginning of data.

When moving the cursor to F7, press [▶] while holding down [SHIFT].

- * As F0 cannot be changed, the cursor will not move to this position. F7 also cannot be deleted.

- ❸ Modify the value.

To enter A–F, hold down “SHIFT” and press [0]–[5].

To insert a new value between F0:–F7, move the cursor to the desired location, and press [F1] (Insert). An initial value of 00 will be inserted. Modify this to your desired value.

To delete a value, move the cursor to the location of the data to be deleted, and press [F2] (Delete).

- ❹ When you finish modifying the message, press [F6] (OK) to finalize the System Exclusive message value.

When the value is finalized, “COMPLETE” will appear just for a moment before the Microscope display (SEQ/Micro) returns.

To cancel System Exclusive message editing and return to Microscope display (SEQ/Micro), press [EXIT]. If the cursor is at the beginning of a System Exclusive message, you can also cancel editing by pressing [◀].

- * If the message is a Roland Type IV System Exclusive message, the XP-80 will automatically calculate the check sum when you finalize values. If you don't care for this, press [F3] (Chk Sum) to open the window and set “Auto Calculate Check Sum” OFF.

Modifying tempo change recorded on the Tempo track

- * If you modify Tempo Change here, the tempo will only change from that Song position to the next Tempo Change. To speed up or slow down the overall tempo of the entire song, change the playback tempo on the Play display (SEQ(Song)).

<Procedure>

- 1 Make sure that the Microscope display (SEQ/Micro) is up.
- 2 Press [TEMPO/BEAT] to select the Tempo track.

Each time [TEMPO/BEAT] is pressed, the selection will cycle through the Tempo track, Beat track, and Phrase track, back to the Tempo track, and so on.

- 3 Press [▲] or [▼] to move ">" to the Tempo Change to be modified.
- 4 Press [▶] to move the cursor to "value" and specify the desired tempo.

Modifying data recorded on the Beat track

You can modify the parameters of data recorded on the Beat track.

- * For details of data, refer to "Data handled by the Beat track" (p.145).

<Procedure>

- 1 Make sure that the Microscope display (SEQ/Micro) is up.
- 2 Press [TEMPO/BEAT] to select the Beat track.

Each time [TEMPO/BEAT] is pressed, the selection will cycle through the Tempo track, Beat track, and Phrase track, back to the Tempo track, and so on.

- 3 Press [▲] or [▼] to move ">" to the data to be modified.
- 4 Press [◀] or [▶] to move the cursor to the data to be modified and set the desired value.

Setting the time signature of a Pattern

Each Pattern has a Pattern Beat that manages the time signature of that Pattern. The Pattern Beat is used as a reference for playing back or recording the Pattern, which is handled separately from the song's time signature (time signature recorded on the Beat track). Normally, the Pattern beat is set to 4/4 time. If the song's time signature is other than 4/4 or if you want to record the Pattern in a time signature different from the song's, you need to set the Pattern beat.

Only a single Pattern Beat can be specified at the beginning of each Pattern so the time signature cannot be changed in the middle of a Pattern. Also, you cannot delete, move and copy Pattern Beat.

<Procedure>

- 1 Make sure that the Microscope display (SEQ/Micro) is up.
- 2 To select a Pattern, press [PATTERN] to open the Pattern Select window and specify the Pattern number.
- 3 Press [TEMPO/BEAT].
- 4 Specify the Pattern Beat.

Inserting new sequencer data into a Phrase track/Pattern

You can insert new sequencer data into any Song position of a Phrase track or Pattern.

11 sequencer data types that can be inserted

- * For details of sequencer data, refer to "Sequencer data handled by Phrase tracks/Patterns" (p.144).

Note: [9]

Adds a single note.

Poly Aft (Polyphonic aftertouch): [SHIFT] + [0]

Applies aftertouch to a specified note.

Control Change: [SHIFT] + [1]

Insert this message when you want to apply modulation, expression or panning.

Program Change: [SHIFT] + [2]

Insert this message when you want to change the instrument sound during a song.

Channel Aft (Channel aftertouch): [SHIFT] + [3]

Applies aftertouch to a specified MIDI channel.

Pitch Bend: [SHIFT] + [4]

Insert this message when you want to modify pitch.

Tune (Tune request): [SHIFT] + [6]

Insert this message when you want to tune an analog synthesizer.

Pattern (Pattern call message): [PATTERN]

Insert this message at the Song position you want the Pattern to play back.

- * If the inserted Pattern is longer than the last measure of the song, Pattern playback will be interrupted in mid-play.
- * Only one Pattern can be played back from a single Phrase track at one time using a Pattern call message. If a Pattern call message is recorded before the Pattern playback reaches the end, the current Pattern playback will be interrupted and playback of the next Pattern will start. If more than one Pattern call message is recorded at the same location, the most recently displayed Pattern on the Microscope display will play back.
- * When a Pattern Call message is recorded in a Pattern, Pattern Call message recorded in a Pattern are ignored. To record data from another Pattern in a Pattern, use the Copy track editing function.

Sys.Excl(Default) (System exclusive message): [SHIFT] + [5]

Inserts the default value of the Exclusive message.

Sys.Excl(GM ON) (GM on message)

Insert this message when you want to initialize the sound source for GM system basic settings.

Sys.Excl(GM OFF) (GM off message)

Insert this message when you want to cancel sound source's GM system basic settings.

<Procedure>

- ❶ Make sure that the Microscope display (SEQ/Micro) is up.
- ❷ Select the Phrase track or Pattern into which you want to insert data.

If you wish to select a Phrase track, press TRACK/PART [1]-[16].

To select a Pattern, press [PATTERN] to open the Pattern Select window and specify the Pattern number.

- ❸ Press [▲] or [▼] to move ">" to the Song position where you want to insert data.

If the Song position for data insertion is not showing on the display, move the cursor to an appropriate Song position (measure-beat-clock) and specify that location using the numeric keys.

- ❹ Press [F1] (Create) to call up the Create Event display (SEQ/Micro).



- ❺ Move the cursor to select the data to be inserted. You can also select the data using the numeric keys.
- ❻ Press [F6] (Execute) to insert the data. The Microscope display (SEQ/Micro) will appear.
- ❼ The inserted data will contain the default parameter value. Change the value as desired.
- * If you don't like the change you've made, you can undo the most recent. Press [UNDO/REDO] to restore it to its pre-modified state.

Changing the tempo during a song

To change the tempo during a song, insert a Tempo Change into the Tempo track. From that Song position on, the song will play back with the new tempo.

- * To speed up or slow down the overall tempo of the entire song, modify the playback tempo on the Play display (SEQ(Song)).

<Procedure>

- ❶ Make sure that the Microscope display (SEQ/Micro) is up.
- ❷ Press [TEMPO/BEAT] to select the Tempo track.

Each time [TEMPO/BEAT] is pressed, the selection will

cycle through the Tempo track, Beat track, and Phrase track, back to the Tempo track, and so on.

- ❸ Move the cursor to an appropriate position (measure-beat-clock) and specify the Song position at which Tempo Change will be inserted, using the numeric keys.

- ❹ Press [F1] (Create).

The Tempo Change has been inserted.

- ❺ The inserted Tempo Change contains the default value. Change the value as desired.

- * If you don't like the Tempo Change you've created, you can undo the most recent. Press [UNDO/REDO] to restore it to its pre-modified state.

Changing the time signature during a song

To change the time signature during a song, insert Beat Change into the Beat track. Starting from the Beat Change insertion position, the song will play back with the new time signature.

- * If the time signature recorded on the Beat track differs from the Pattern Beat setting, the Beat track's time signature will be used. For example, if a Pattern in 3/4 has been assigned to the middle of a song in 4/4, playback of that Pattern will be go off from the Phrase track. To play the song correctly, insert the Beat Change of 3/4 into the Beat track. To return the time signature back to 4/4, insert the Beat Change of 4/4 to the measure next to the last measure of the Pattern.

<Procedure>

- ❶ Make sure that the Microscope display (SEQ/Micro) is up.
- ❷ Press [TEMPO/BEAT] to select the Beat track.

Each time [TEMPO/BEAT] is pressed, the selection will cycle through the Tempo track, Beat track, and Phrase track, back to the Tempo track, and so on.

- ❸ Move the cursor to an appropriate Song position (measure-beat-clock) and specify the Song position at which Beat Change will be inserted using the numeric keys.

- ❹ Press [F1] (Create) to call up the Create Event display (SEQ/Micro).

- ❺ Move the cursor to "Beat."

- * If you move the cursor to "Key Signature" here, you can insert a desired key signature.

- ❻ Press [F6] (Execute) to insert the Beat Change.

The Microscope display (SEQ/Micro) will appear.

- ❼ The inserted Beat Change will contain the default value. Change the value as desired.

- * If you don't like the Beat Change you've created, you can undo the most recent. Press [UNDO/REDO] to restore it to its pre-modified state.

Erasing sequencer data

You can erase only the specified sequencer data from where it exists.

- * It is not possible to erase the Tempo Change located at the beginning of the Tempo track, the Beat Change or key signature located at the beginning of the Beat track, and the Pattern Beat.

<Procedure>

- 1 Make sure that the Microscope display (SEQ/Micro) is up.
- 2 Select the track or Pattern from which you want to erase data.

To select a Phrase track, press TRACK/PART [1]–[16].

To select a Pattern, press [PATTERN] to open the Pattern Select window and specify the Pattern number.

You can select the Tempo track or Beat track by pressing [TEMPO/BEAT]. Each time [TEMPO/BEAT] is pressed, the selection will cycle through the Tempo track, Beat track, and Phrase track, back to the Tempo track, and so on.

- 3 Press [▲] or [▼] to move “>” to the data that you wish to erase.
 - 4 Press [F2] (Erase) to erase the data.
- * If you don't like the change after erasing, you can undo the most recent. Press [UNDO/REDO] to restore it to its pre-erased state.

Moving sequencer data

You can move only the specified sequencer data from where it exists.

- * It is not possible to move the Tempo Change located at the beginning of the Tempo track, the Beat Change or key signature located at the beginning of the Beat track, and the Pattern Beat.

<Procedure>

- 1 Make sure that the Microscope display (SEQ/Micro) is up.
- 2 Select the track or Pattern from which you wish to move data.

If you wish to select a Phrase track, press TRACK/PART [1]–[16].

To select a Pattern, press [PATTERN] to open the Pattern Select window and specify the Pattern number.

You can select the Tempo track or Beat track by pressing [TEMPO/BEAT]. Each time [TEMPO/BEAT] is pressed, the selection will cycle through the Tempo track, Beat track, and Phrase track, back to the Tempo track, and so on.

- 3 Press [▲] or [▼] to move “>” to the data that you wish to move.
- 4 Press [F3] (Move) to call up the Move Event display (SEQ/Micro).

The display will show only the data to be moved.

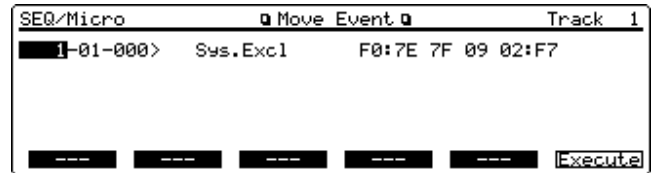

- 5 Move the cursor to the measure, beat and clock and input each value to specify the new Song position to which the data will be moved.
- 6 Press [F6] (Execute) to move the data.

The Microscope display (SEQ/Micro) will appear.

- * If you don't like the change after moving, you can undo the most recent. Press [UNDO/REDO] to restore it to its pre-move state.

Copying sequencer data

You can copy sequencer data to any specified Song position, a useful function when you want to use the same data several times.

<Procedure>

- 1 Make sure that the Microscope display (SEQ/Micro) is up.
- 2 Select the track or Pattern from which you wish to copy data.

If you wish to select a Phrase track, press TRACK/PART [1]–[16].

To select a Pattern, press [PATTERN] to open the Pattern Select window and specify the Pattern number.

You can select the Tempo track or Beat track by pressing [TEMPO/BEAT]. Each time [TEMPO/BEAT] is pressed, the selection will cycle through the Tempo track, Beat track, and Phrase track, back to the Tempo track, and so on.

- 3 Press [▲] or [▼] to move “>” to the data that you wish to copy.
- 4 Press [F4] (Copy) to copy the data.

While the data is being copied, the display will show “Copying...”

- 5 Press [▲] or [▼] to move “>” to the Song position in which sequencer data will be placed.

If the Song position for data placement is not displayed, move the cursor to an appropriate Song position (measure-beat-clock) and specify the Song position where the copied data will be placed, using the numeric keys. When you wish to place the copied data into another Phrase track or Pattern, select the Phrase track or Pattern and specify the Song position where you wish to place the copied data.

- 6 Press [F5] (Place) to paste the copied data.
- * If you don't like the change after copying, you can undo the most recent. Press [UNDO/REDO] to restore it to its pre-copy state.

Chapter 6. Realtime Phrase Sequencing (RPS)

RPS (Realtime Phrase Sequencing) lets you play back Patterns simply by pressing keyboard keys assigned to the Patterns.

For example, if you use RPS to assign an intricate Phrase that is difficult to play during a live performance to a key, you could play it perfectly simply by pressing that single key at the right point during the performance.

RPS allows you to play up to eight Patterns at once so you can create individual drum, bass, keyboard, etc. Patterns and combine them to create a new song. You can also record the performance using RPS for phrase sampling.

Getting ready to use RPS

Before using RPS, you first have to record the necessary Phrases in Patterns (p. 106, p. 113).

Once Patterns are ready, assign a Pattern to each key and specify how the Pattern will play back. As this setting can be saved as part of song data, you can enjoy playback with RPS at any time.

RPS parameters

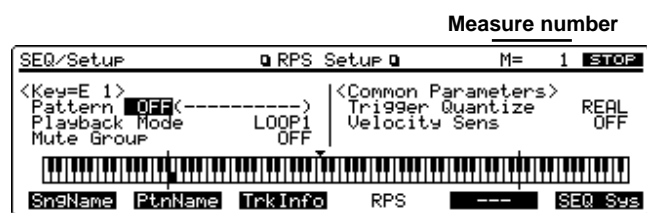

<Key= >

The current note name is displayed.

- * The Pattern, Playback Mode and Mute Group parameters must be set for each key. The XP-80 is equipped with a 76-note keyboard and the XP-60 is equipped with a 61-note keyboard, but you're able to set this parameter to any note from C-1 to G9.

Pattern

Selects the Pattern to be assigned to each key. The pattern name will appear in parentheses ().

Keys for which no Pattern will be assigned should be kept OFF.

Select STOP and that key will stop playback of the Patterns being played back by RPS (stop trigger).

- * The display graphically indicates keyboard assignments. A "■" symbol will show the set keys, "|" the keys for which Patterns are assigned, and "+" for the key set to STOP. Keys not indicated are set OFF.

Playback Mode

Specifies how the Pattern will play back.

LOOP1: The Pattern will continue to repeat as long as the key is pressed.

LOOP2: The Pattern will begin playback when the key is pressed and continue to repeat. To stop playback, either press the stop trigger key or press the same key again.

ONCE: The Pattern will play back once when the key is pressed.

Mute Group

This function prevents same group Patterns from sounding at the same time. In an actual performance, a fill-in and bridge is never played at the same time. You can make sure this will never happen if you set the fill and bridge to the same Mute Group number.

You can set up to 32 Mute Groups. If you don't want to use a Mute Group, set this parameter to OFF.

- * Individual settings for the following parameters can be created for each song.

Trigger Quantize

Selects how the Pattern will begin playing back when the key is pressed.

REAL: When the key is pressed, the Pattern will immediately start to play back.

BEAT: When the key is pressed in the middle of a beat (during song playback), the Pattern will begin playing back from the beginning of the next beat.

MEASURE: When the key is pressed in the middle of a measure (during song playback), the Pattern will begin playing back from the beginning of the next measure.

Velocity Sens (Velocity sensitivity)

To play back a Pattern retaining the recording volume level, set this parameter OFF.

To change the volume level of a Pattern by key press strength, set this parameter to LOW (low volume), MID (medium volume) or HIGH (high volume).

- * The Velocity Sens parameter settings will be retained until it is reset next time.

<Procedure>

- 1 Make sure that the Play display (SEQ(Song)) is up.
 - 2 Move the cursor to the song number and select the song which needs an RPS setup.
 - 3 Press [F1] (Setup).
 - 4 Press [F4] (RPS) to call up the RPS Setup display.
- * If you have selected a song previously saved to disk in step 2, a window asks "This Song is not Internal Song. Load anyway?" If you want to erase the song from the internal memory and load the new song, press [F5] (OK). If you decide not to erase the song from the internal memory, press [F6] (Cancel).
- 5 Select the key (note) to which you want to assign a Pattern by pressing that key on the keyboard.
 - * You can also select a key by pressing TONE SELECT [1]–[4]. To select a key that is outside XP-60/XP-80 keyboard range, use these buttons.
 - 6 Move the cursor to "Pattern" and select the Pattern you want to assign.
 - 7 Move the cursor to "Playback Mode" and select how the Pattern will play back.
 - 8 Move the cursor to "Mute Group" and group the Pattern.
 - 9 Repeat steps 5 to 8 to perform settings for each key.
 - 10 Move the cursor to "Trigger Quantize" and specify the way how the Pattern will start to play back.

- ① Move the cursor to “Velocity Sens” to specify the volume level for the Pattern playback.
- ② After you complete settings, press [EXIT] to return to the Play display (SEQ(Song)).

Playing using RPS

RPS lets you play back up to eight Patterns simultaneously. And unlike the conventional playback of individual Patterns which requires the song to first be loaded into internal memory, Patterns can be quick played when RPS is in use.

<Procedure>

- ① Make sure that the Play display (SEQ(Song)) is up.
- ② Make sure that RPS setup has been completed correctly.
- ③ Press [RPS] to light the indicator.

Now the XP-80's keyboard is set for using RPS.

The keys to which Patterns are assigned using the Pattern parameter (Song/Setup/RPS Setup) will play back, and the key set for STOP will function as a stop trigger. The keys that remain OFF will be used for normal playing.

- ④ Press [STOP/PLAY] to play back the song.
- * If you are not playing back a song, the Pattern will start playing back immediately when the key is pressed, even if the Trigger Quantize parameter (Song/Setup/RPS Setup) is set to BEAT or MEASURE.
- ⑤ Press the key to which the Pattern is assigned to play back the Pattern.
- * To interrupt playback of the Pattern, press the stop trigger key. If you have set the Playback Mode parameter (Song/Setup/RPS Setup) to LOOP2, you can stop the Pattern playback by again pressing the same key you used to initiate Pattern play.
- * If you press [RPS] OFF (indicator will go off) while a Pattern is playing back, the keyboard will revert for normal playing, but Pattern playback will continue. To stop Pattern playback, press [RPS] ON again.

Playing a Pattern from a external MIDI keyboard using RPS

RPS allows you to use an external MIDI keyboard to play Patterns if so desired. To do this, assign a Pattern to a key (note number) outside XP-60/XP-80 keyboard range (C2–C7/E1–G7), for example. With this assignment, you can play back that Pattern by pressing the key on the external MIDI keyboard and use the XP-60/XP-80's keyboard for your conventional playing to extend your performance scope.

<Procedure>

- ① Make sure that the Play display (SEQ(Song)) is up.
- ② Connect the XP-60/XP-80's MIDI IN to the external MIDI keyboard's MIDI OUT via MIDI cable.
- ③ Press [SYSTEM] to light the indicator.
- ④ Continue pressing [F3] (MIDI) until the MIDI Param 1 display appears.

Each time [F3] (MIDI) is pressed, the display will cycle through MIDI Param 1 display, MIDI Param 2 display, and Bank Select Group display, then back to the MIDI Param 1 display, and so on.

- ⑤ Move the cursor to “Remote Keyboard Sw” and set this parameter ON.

- ⑥ Press [EXIT] to return to the Play display (SEQ(Song)).

Now you can play back a Pattern from the external MIDI device.

- ⑦ Make sure that the RPS setup has been completed correctly.

- ⑧ Press [RPS] to make the indicator light.

- ⑨ Press [STOP/PLAY] to play back a song.

- * If you're not playing back a song, the Pattern will start to play back immediately when the key is pressed, even if the Trigger Quantize parameter (Song/Setup/RPS Setup) has been set to BEAT or MEASURE.

- ⑩ Play back the Pattern by pressing the key on the external MIDI keyboard.

Recording performance using RPS

You can also realtime record a performance using RPS. This lets you easily remix Patterns to create a song.

- * With realtime recording using RPS, Patterns are converted into actual sequencer data as they are being recorded. Unlike assigning a Pattern in step recording, a Pattern Call message will not be recorded.

- * If [RPS] is ON when you save a song as an MRC Pro song to disk, this setting will also be saved as part of the song data. Each time you select this song, playback will use RPS.

<Procedure>

- ① Make sure that the Play display (SEQ(Song)) is up.
- ② Make sure that RPS setup has been completed correctly.
- ③ Press [RPS] to light the indicator.
- ④ Press [REC] to get ready for realtime recording.
- ⑤ Start recording.
- * If you have set the Count In parameter (SEQ/Realtime Rec Stand-by) to Wait Note, recording won't start even when you press the key to which the Pattern is assigned or the stop trigger key.
- ⑥ When the recording finishes, press [STOP/PLAY].

.....
<Tips for using RPS>

Record only Note messages in a Pattern

If a Pattern contains MIDI messages other than Note messages, notes may be delayed during playback using RPS if many MIDI messages have been recorded. Messages other than Note messages are best recorded on a Phrase track.

Synchronizing playback of Patterns

When you wish to sync the playback of several Patterns, a song must be played back. This is because Patterns play back with the song's time signature (on the Beat track).

If the Phrase tracks contain no sequencer data, the song will not play back, making syncing between Patterns impossible. If this is the case, insert several blank measures on a Phrase track and loop play.

Deciding which keys to assign Patterns to

When you use RPS only to play Patterns, it does not matter which keys you assign Patterns to. But if you want to also play the keyboard normally with the Pattern parameter (Song/Setup/RPS Setup) OFF, you need to consider a range of keys to use for RPS.

Because keys to which Patterns are assigned cannot be checked while playing, it is a good idea to decide on your key assignments to be sure they're appropriate for the type of Patterns.

.....

Chapter 7. Playing songs in sequence (Chain Play)

Chain Play successively quick plays songs from disk in the order you specify. Since you can also chain play songs and data files from two or more disks, there is no limitation in the number of songs or memory capacity. Songs as well as data files can be loaded, so you can play back songs using a wide range of sounds.

Getting ready for Chain Play

Before using Chain Play, you must create a chain to specify the playback sequence or order for the songs or data files as well as the way they will play back. Each chain can contain settings for up to 98 songs or data files (steps).

<Procedure>

- ❶ Insert a disk containing songs or data files you wish to chain play into the disk drive.
- ❷ Press [CHAIN PLAY].

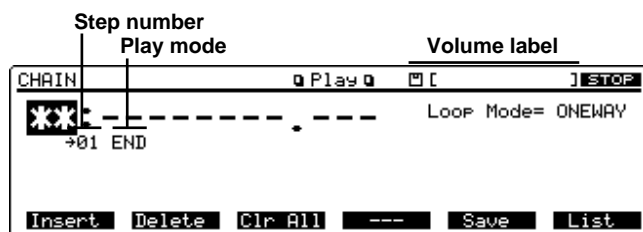

- * If you wish to create a new chain over a preexisting chain, erase the existing chain.

Pressing [F3] (Clr All) will open a window asking "Clear All Step. OK?" If you want to erase the chain, press [F5] (OK). To cancel the operation, press [F6] (Cancel).

- ❸ Move the cursor to the Play mode and specify how the song should start.

PLAY: Song to play back automatically.

WAIT: Song to play back when [STOP/PLAY] is pressed.

LOAD: Data file will be loaded immediately.



- * The Play mode of a new step indicates END, which means that the selected step is the last step of the chain.
 - * LOAD can be selected only when you are loading data files. To play back songs, select either PLAY or WAIT.
- ❹ Press [▶] to move the cursor to the file name and select the song to be played back or the data file to be loaded.
 - ❺ Press [FWD] to advance to the next step.
 - ❻ Repeat steps 3 to 5 to configure a chain.

To directly move to the last step, hold down [SHIFT] as you press [FWD].

To return to the previous step, press [BWD]. To return to the

first step, hold down [SHIFT] as you press [BWD].

To insert a new step, press [F1] (Insert). The step currently displayed with a "→" symbol (current step) will move back and a new step will be inserted. The settings of the current step will be copied to the new step. Change the settings as desired.

To delete the current step, press [F2] (Delete).

- * To configure a chain that consists of songs or data files from two or more disks, replace the disk as you create the chain.

<Tips on creating a Chain>

Chain Play is similar to a CD player's programmed play. Apart from playing songs successively, you can also have songs pause before playback in the middle of playback (WAIT) or load the sound data specific for the song (LOAD).

For instance, suppose you have created a chain with settings:

- 01 LOAD 01:SOUND_01.SVD
- 02 PLAY 01:SONG_001.SVQ
- 03 PLAY 02:SONG_002.SVQ
- 04 WAIT 03:SONG_003.SVQ
- 05 PLAY 04:SONG_004.SVQ

This means that "SOUND_01.SVD" will be loaded, "SONG_001.SVQ" quick played, "SONG_002.SVQ" quick played and "SONG_003.SVQ" will be in waiting. When you press [STOP/PLAY], chain play will take place starting with "SONG_003.SVQ," then "SONG_004.SVQ."

So if you use this setting for live performance, you can play the first and second songs in medley, introduce your band members, and then play the third and fourth songs in medley again.

Saving a chain to disk

The chain you've created will be lost if you turn the power off. If you wish to keep the chain, save it to disk as a chain file.

<Procedure>

- 1 Insert a disk into the disk drive.
- 2 Make sure that the Play display (CHAIN) is up.
- 3 Press [F5] (Save) to call up the Save display (CHAIN/Save).

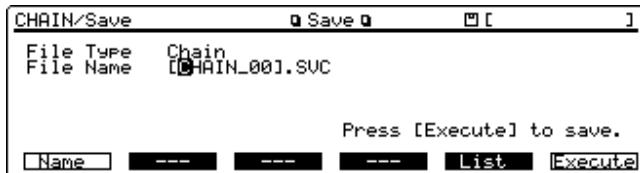

- 4 Move the cursor to the character input location and input characters to assign a file name.

When assigning the file name using the Name window, press [F1] (Name).

To view the list of chain files saved on disk, press [F5] (List). To select a chain file from the list, move the cursor to the desired chain file and press [F6] (Select) or [ENTER].

- 5 Press [F6] (Execute) to save the chain.

The file name extension “.SVC” attaches automatically.

- * If you try to save a file with a pre-existing name, a window asks “File Name duplicate. Overwrite?” To rewrite the file, press [F5] (OK). To cancel saving, press [F6] (Cancel).
- * When you try to save data to a disk which has not been formatted for the XP-80, a window asks “Unformatted disk. Format?” When formatting the disk, press [F5] (OK). If you decide not to format the disk, press [F6] (Cancel).
- 6 Press [EXIT] to return to the Play display (CHAIN).

Chain play

If you create a chain containing the songs for your stage setup, you can play back songs in the appropriate order simply by pressing [STOP/PLAY]. Songs will be quick played without any gaps between them.

<Procedure>

- 1 Insert a disk containing the chain file into the disk drive.
- 2 Make sure that the Play display (CHAIN) is up.
- 3 Move the cursor to the chain file number and select a chain.

If you select a chain, the file number and file name will be boxed.



- 4 Press [ENTER] to finalize the chain file.

The chain file will be loaded into the XP-80 from the disk.

- * To view the list of chain files saved on disk, press [F6] (List). To select a chain file from the list, move the cursor to the desired chain file and press [F6] (Select) or [ENTER].
- * Pressing [STOP/PLAY] instead of [ENTER] will immediately load the chain file and start chain play.
- 5 Move the cursor to “Loop Mode” and specify how the chain is to play back.

ONEWAY: The chain will play back once.

REPEAT: The chain will play back repeatedly.

- * Loop Mode parameter settings will be saved as part of a chain file when it is saved to disk.
- * Loop Mode parameter settings can also be modified during chain play.
- 6 Press [STOP/PLAY] to start chain play.

If the Play mode for the step 01 has been set to WAIT, song playback will not start until you press [STOP/PLAY] again. If LOAD has been selected, the data file will be loaded immediately.

- * If you wish to start chain play during song play, press [FWD] or [BWD] to move to a new step and press [STOP/PLAY].
- * To advance to the next step during chain play, press [FWD]. To return to the beginning of the current step, press [BWD].
- 7 To stop chain play, press [STOP/PLAY].

If the Loop Mode parameter has been set to ONEWAY, chain play will stop automatically when chain playback reaches the end of the chain. If REPEAT has been selected, press [STOP/PLAY] to stop chain play.

- * Starting/stopping chain play with a Start or Stop message from an external MIDI device is not possible. During chain play, Continue, Song Position Pointer, Song Select, and MIDI Clock will also not be received.
- * If a single chain contains songs or data files from two or more disks, the file number which is not found in the currently inserted disk will be indicated with “**.” If the file of the current step is not contained in the currently inserted disk, the display upper right will show “ERROR” and chain play will stop temporarily. If this is the case, insert the new disk and press [STOP/PLAY] to restart chain play.

Chapter 8. XP-80 memory settings (Utility mode)

The Utility mode allows you to store Patch/Performance/Rhythm Set settings (Write), and transmit data (Data Transfer), as well as other global XP-80 memory settings.

About Utility mode

The XP-80 goes into Utility mode if you press [UTILITY]. The indicator will light. Utility mode offers eight functions categorized into three groups – Menu 1–Menu 3.

Menu 1

Write

This function writes Patch, Performance or Rhythm Set settings you've modified into user memory.

Copy

This function copies data from a Patch, Performance or Rhythm Set into the current Patch, Performance or Rhythm Set.

Initialize

This resets parameters of the current Patch, Performance or Rhythm Set to default factory settings.

Data Transfer

This function transmits Patch, Performance, Rhythm Set or System settings to an external MIDI device.

Protect (User memory protect)

This function prevents user memory from being accidentally rewritten.

Menu 2

Song Init (Song initialize)

This function clears the internal song.

Memory Info (Internal memory information)

This function checks the amount of data stored in the internal memory.

Menu 3

Factory (Factory preset)

This function resets all the settings stored in the XP-80 to the factory default settings.

(Basic Procedure)

- 1 Press [UTILITY] to call up the Utility Menu display (UTILITY).



- * The type of data that will be written, copied and initialize depends on the mode you are in when you press [UTILITY].
- 2 Press [F6] (Menu) to select the menu containing the function you want.

Each time [F6] (Menu) is pressed, the selection will cycle through Menu 1, Menu 2 and Menu 3, then back to Menu 1 and so on.

- 3 Press any button from [F1] to [F5] to select the function you want.

The display of the function you've selected will appear.

- * The desired function can be selected by pressing [INC]/[DEC] or cursor buttons, or turning the VALUE dial to move the cursor, and pressing [ENTER] on the Utility Menu display (UTILITY). It is possible to select a function by inputting a number corresponding to the function using the numeric keys and pressing [ENTER] on the Utility Menu display (UTILITY).

- 4 Set parameters as necessary on each function's display.

- * To cancel the operation, press [EXIT].

- 5 Press [F6] (Execute) to execute operation.

When the operation is completed, "COMPLETE" will appear.

- 6 To return to the Utility Menu display (UTILITY), press [EXIT]. To return to the original mode display, press [UTILITY].

Storing sound data in user memory – 1 Write

If you turn the power off or select another Patch, Performance, or Rhythm Set after you have modified a Patch, Performance, or Rhythm Set settings, the modified data will be lost. If you wish to keep the data, store it into user memory.

Performance write

The settings of the current Performance will be written into user memory. Press [UTILITY] in Performance mode, then perform Write operation.



Source

Temp indicates that the current Performance will be written into internal memory. The name of the selected Performance will be displayed in parentheses ().

Destination

Selects where the Performance will be written. The name of the selected Performance will be displayed in parentheses ().

Patch write

The settings of the current Patch will be written into user memory. Press [UTILITY] in Patch mode, then perform Write operation.



Source

Temp indicates that the current Patch will be written into internal memory. The name of the selected Patch will be displayed in parentheses ().

Destination

Selects the writing destination Patch. The name of the selected Patch will be displayed in parentheses ().

<Compare function>

The Compare function allows you to play the Patch currently residing in the writing destination, so that you can check whether or not you want to overwrite it. To play the Patch resident in the writing destination, press [F1] (Compare) to access the Patch Compare display (UTILITY/Write).

You can select the writing destination Patch on this display

as well. After selecting the writing destination Patch, press [F1] (Write) or [EXIT] to return to the Patch Write display (UTILITY/Write).

- * Please be aware that when the Compare function is used to play a Patch, it may sound different from when it is played normally.

Rhythm Set write

The settings of the current Rhythm Set will be written into user memory. Press [UTILITY] in Rhythm Set mode, then perform Write operation.



Source

Temp indicates that the current Rhythm Set will be written into internal memory. The name of the selected Rhythm Set will be displayed in parentheses ().

Destination

Selects the writing destination Rhythm Set. The name of the selected Rhythm Set will be displayed in parentheses ().

<Procedure>

- 1 Make sure that the Utility Menu display (UTILITY) is up.
- 2 Press [F6] (Menu) to select Menu 1, then [F1] (Write) to select Write.

This function can also be selected by moving the cursor to “1 Write” and pressing [ENTER] on the Utility Menu display (UTILITY), or pressing the numeric key [1], then [ENTER].

- 3 Change the number to select the writing destination.
- * When song initialization is completed, the Play display (SEQ(Song)) appears.
- 4 Press [F6] (Execute) to write the Patch, Performance, or Rhythm Set.

When writing is completed, the Play display of the written Patch, Performance or Rhythm Set will appear.

- * If you execute the Write operation with the Write Operation parameter (UTILITY/Protect/User Memory Protect) ON, a window will show “Write Protect ON.” Reset this parameter OFF to write settings into internal memory. After finishing settings, press [EXIT] or [ENTER] to close the window. Then press [F6] to execute writing again. The Write Operation parameter remains OFF, once set OFF, until the power is turned off.

Copying sound source settings – 2 Copy

This function lets you copy data of any Patch, Performance, or Rhythm Set into the current Patch, Performance, or Rhythm Set. Using this function effectively makes editing easier.

Performance copy

To copy the settings of a Performance, press [UTILITY] in Performance mode, then perform Copy operation.

Performance Part copy

The Part settings of a Performance will be copied to the Part you specify of the current Performance.

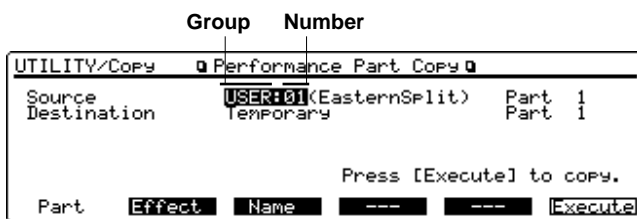

Source

Selects the Performance from which data will be copied. The name of the selected Performance will be displayed in parentheses ().

Part (Source Part)

Selects the Part to be copied.

Destination

Temporary indicates that the copy destination is the current Performance.

Part (Destination Part)

Selects the Part data will be copied to.

<Procedure>

- ❶ Make sure that the Utility Menu display (UTILITY) is up.
- ❷ Press [F6] (Menu) to select Menu 1, then [F2] (Copy) to select Copy.

This function can also be selected by moving the cursor to “2 Copy” and pressing [ENTER] on the Utility Menu display (UTILITY), or pressing the numeric key [2], then [ENTER].

- ❸ Press [F1] (Part) to call up the Performance Part Copy display (UTILITY/Copy).
- ❹ Move the cursor to “Source” and modify the group and number to select the copy source Performance.

If you wish to select the current Performance for copy source, set TEMP.

- ❺ Press [▶] to move the cursor to “Part” (Source Part), then select the copy source Part.

You can also select the Part by pressing TRACK/PART [1]-[16].

- ❻ Press [▼] to move the cursor to “Part” (Destination Part), then select the copy destination Part.

You can also select the Part by pressing TRACK/PART [1]-[16].

- ❼ Press [F6] (Execute) to copy the Part settings.

Performance effects copy

The effects settings of a Performance or Patch will be copied to the current Performance.

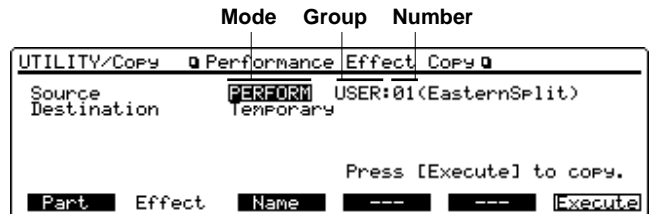

Source

Selects the Performance or Patch from which effects settings will be copied. The name of the selected Performance or Patch will be displayed in parentheses ().

Destination

Temporary indicates that the copy destination is the current Performance.

<Procedure>

- ❶ Make sure that the Utility Menu display (UTILITY) is up.
- ❷ Press [F6] (Menu) to select Menu 1, then [F2] (Copy) to select Copy.

This function can also be selected by moving the cursor to “2 Copy” and pressing [ENTER] on the Utility Menu display (UTILITY), or pressing the numeric key [2], then [ENTER].

- ❸ Press [F2] (Effect) to call up the Performance Effect Copy display (UTILITY/Copy).
- ❹ Move the cursor to the mode and select PERFORM or PATCH.
- ❺ Press [▶] to move the cursor, then change the group and number to select the copy source Performance or Patch.
- ❻ Press [F6] (Execute) to copy the effects settings.

Performance name copy

The name of a Performance will be copied to the current Performance.

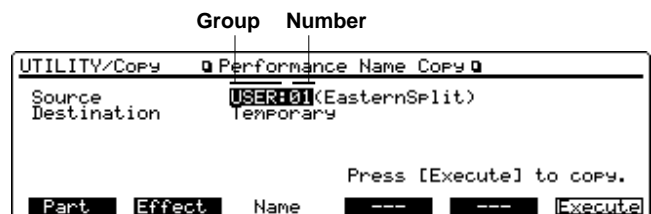

Source

Selects the Performance whose name will be copied. The name of the selected Performance will be displayed in parentheses ().

Destination

Temporary indicates that the copy destination is the current Performance.

<Procedure>

- ❶ Make sure that the Utility Menu display (UTILITY) is up.
- ❷ Press [F6] (Menu) to select Menu 1, then [F2] (Copy) to select Copy.

This function can also be selected by moving the cursor to “2 Copy” and pressing [ENTER] on the Utility Menu (UTILITY) display, or pressing the numeric key [2], then [ENTER].

- ❸ Press [F3] (Name) to call up the Performance Name Copy display (UTILITY/Copy).
- ❹ Change the group and number to select the copy source Performance or Patch.
- ❺ Press [F6] (Execute) to copy the Performance name.

Patch copy

When you want to copy Patch settings to the current Patch, press [UTILITY] in Patch mode and perform Copy operation.

Patch Tone copy

Tone settings of a Patch will be copied to the Tone you specify of the current Patch.

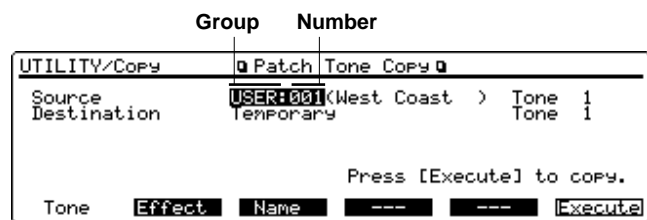

Source

Selects the Patch from which Tone settings will be copied. The name of the selected Patch will be displayed with parentheses ().

Tone (Source Tone)

Selects the Tone which will be copied.

Destination

Temporary indicates that the copy destination is the current Patch.

Tone (Destination Tone)

Selects the Tone to which data will be copied.

<Procedure>

- ❶ Make sure that the Utility Menu display (UTILITY) is up.
- ❷ Press [F6] (Menu) to select Menu 1, then [F2] (Copy) to select Copy.

This function can also be selected by moving the cursor to “2 Copy” and pressing [ENTER] on the Utility Menu display (UTILITY), or pressing the numeric key [2], then [ENTER].

- ❸ Press [F1] (Tone) to call up the Patch Tone Copy display (UTILITY/Copy).
- ❹ Move the cursor to “Source” and change the group and number to select the copy source Patch.

To select the current Patch, specify TEMP.

- ❶ Press [▶] to move the cursor to “Tone” (Source Tone) and select the copy source Tone.

The Source Tone can also be selected by pressing TONE SELECT [1]–[4].

- ❷ Press [▼] to move the cursor to “Tone” (Destination Tone) and select the copy destination Tone.

The Destination Tone can also be selected by pressing TONE SELECT [1]–[4].

- ❸ Press [F6] (Execute) to copy Tone settings.

Patch effects copy

The effects settings of a Patch or Performance will be copied to the current Patch.

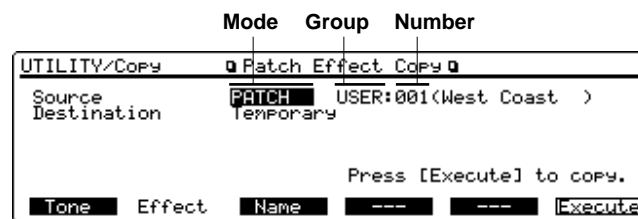

Source

Selects the Patch or Performance from which effects settings will be copied. The name of the selected Patch or Performance will be displayed in parentheses ().

Destination

Temporary indicates that the copy destination is the current Patch.

<Procedure>

- ❶ Make sure that the Utility Menu display (UTILITY) is up.
- ❷ Press [F6] (Menu) to select Menu 1, then [F2] (Copy) to select Copy.

This function can also be selected by moving the cursor to “2 Copy” and pressing [ENTER] on the Utility Menu display (UTILITY), or pressing the numeric key [2], then [ENTER].

- ❸ Press [F2] (Effect) to call up the Patch Effect Copy display (UTILITY/Copy).
- ❹ Move the cursor to the mode and select PATCH or PERFORM.
- ❺ Press [▶] to move the cursor, then change the group and number to select the copy source Patch or Performance.
- ❻ Press [F6] (Execute) to copy the effects settings.

Patch name copy

The name of a Patch will be copied to the current Patch.

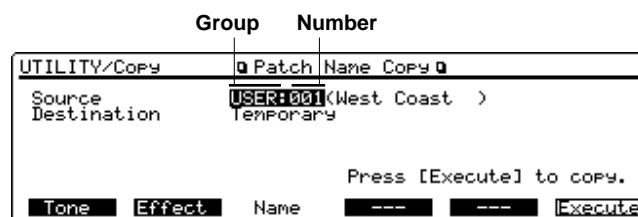

Source

Selects the Patch whose name will be copied. The name of the selected Patch will be displayed in parentheses ().

Destination

Temporary indicates that the copy destination is the current Patch.

<Procedure>

- ❶ Make sure that the Utility Menu display (UTILITY) is up.
- ❷ Press [F6] (Menu) to select Menu 1, then [F2] (Copy) to select Copy.

This function can also be selected by moving the cursor to “2 Copy” and pressing [ENTER] on the Utility Menu display (UTILITY), or pressing the numeric key [2], then [ENTER].

- ❸ Press [F3] (Name) to call up the Patch Name Copy display (UTILITY/Copy).
- ❹ Change the group and number to select the copy source Patch.
- ❺ Press [F6] (Execute) to copy the Patch name.

Rhythm Set copy

When you want to copy Rhythm Set settings to the current Rhythm Set, press [UTILITY] in Rhythm Set mode and perform Copy operation.

Rhythm key copy

Individual key settings in a Rhythm Set will be copied to each key in the current Rhythm Set.

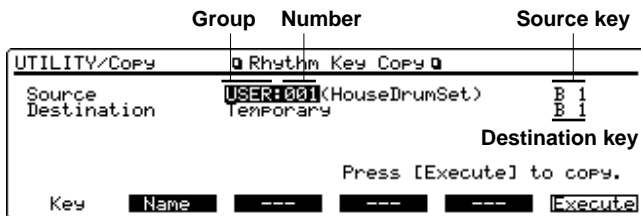

Source

Selects the Rhythm Set from which key settings will be copied. The name of the selected Rhythm Set will be displayed in parentheses ().

Source key

Selects a percussion note (key) which will be copied.

Destination

Temporary indicates that the copy destination is the current Rhythm Set.

Destination key

Selects the key to which copied settings will be placed.

<Procedure>

- ❶ Make sure that the Utility Menu display (UTILITY) is up.
- ❷ Press [F6] (Menu) to select Menu 1, then [F2] (Copy) to select Copy.

This function can also be selected by moving the cursor to “2 Copy” and pressing [ENTER] on the Utility Menu display (UTILITY), or pressing the numeric key [2], then [ENTER].

- ❸ Press [F1] (Key) to call up the Rhythm Key Copy display (UTILITY/Copy).
- ❹ Move the cursor to “Source,” then change the group and number to select the copy source Rhythm Set.

To select the current Rhythm Set, specify TEMP.

- ❺ Press [▶] to move the cursor to the source key and select the copy source key.

The source key can also be selected through note input on the keyboard or by pressing TONE SELECT [1]-[4].

- ❻ Press [▼] to move the cursor to the destination key and select the copy destination key.

The destination key can also be selected through note input on the keyboard or by pressing TONE SELECT [1]-[4].

- ❼ Press [F6] (Execute) to copy key settings.

Rhythm Set name copy

The name of a Rhythm Set will be copied to the current Rhythm Set.

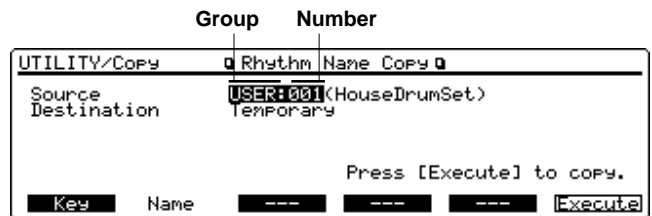

Source

Selects the Rhythm Set whose name will be copied. The name of the selected Rhythm Set will be displayed in parentheses ().

Destination

Temporary indicates that the copy destination is the current Rhythm Set.

<Procedure>

- ❶ Make sure that the Utility Menu display (UTILITY) is up.
- ❷ Press [F6] (Menu) to select Menu 1, then [F2] (Copy) to select Copy.

This function can also be selected by moving the cursor to “2 Copy” and pressing [ENTER] on the Utility Menu display (UTILITY), or pressing the numeric key [2], then [ENTER].

- ❸ Press [F2] (Name) to call up the Rhythm Name Copy display (UTILITY/Copy).
- ❹ Change the group and number to select the copy source Rhythm Set.
- ❺ Press [F6] (Execute) to copy the Rhythm Set name.

Initializing sound source settings – 3 Initialize

This function resets settings of the current Patch, Performance, or Rhythm Set to a standard value or to factory default settings.

- * Only current data will be initialized, and data resident in user memory will not be rewritten. To reset all settings to factory defaults, execute Factory Preset (UTILITY/Preset/Factory Preset).

Data can be initialized in two ways depending on the application.

Mode (Initialize mode)

DEFAULT: Resets current data to the standard values called 'initial data' (INIT PATCH, INIT PERFORM or INIT SET). This mode is selected when creating sound from scratches.

PRESET: Resets the current data in user memory to the factory settings.

- * If the current data is a Patch, Performance or Rhythm Set in preset memory (PR-A-PR-C, GM), and initialization is performed with PRESET specified, the data will be reset to the value of the correspondingly numbered user memory.

Performance initialize

To initialize Performance settings, press [UTILITY] in Performance mode and execute initialization.

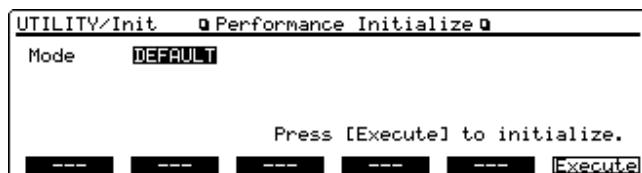

Patch initialize

To initialize Patch settings, press [UTILITY] in Patch mode and execute initialization.



Rhythm Set initialize

To initialize Rhythm Set settings, press [UTILITY] in Rhythm Set mode and execute initialization.



There are two ways to initialize a Rhythm Set. One is to initialize only the settings of the specified key of the Rhythm Set (Key). The other is to initialize the settings of the entire Rhythm Set (All). Select either method by pressing [F1] (Key) or [F2] (All).

When Key is selected, move the cursor to Key and select the key to be initialized. You can specify the key to be initialized via the keyboard or by pressing TONE SELECT [1]-[4].

<Procedure>

- 1 Make sure that the Utility Menu display (UTILITY) is up.
 - 2 Press [F6] (Menu) to select Menu 1, then press [F3] (Init) to select Initialize.
- You can also select Initialize by moving the cursor to "3 Initialize" and pressing [ENTER] on the Utility Menu display (UTILITY) or pressing the numeric key [3], then [ENTER].
- 3 Make sure that the cursor is positioned at "Mode" and select initialization method.
 - 4 Press [F6] (Execute) to perform initialization.

Transmitting sound settings – 4 Data Transfer

This function lets you transmit sound source or System settings that are in the XP-80's memory or stored on disk to an external MIDI device or to record them in the internal song.

Transmitting data to an external MIDI device

The process of transmitting Patch, Performance, Rhythm Set or System data to an external MIDI device is called 'bulk dump.' This process is used when two XP-80s with the same Patch, Performance and/or Rhythm Set settings are connected for performance or when recording Patch, Performance, Rhythm Set or System data into an external MIDI device as a backup for accidental data deletion.

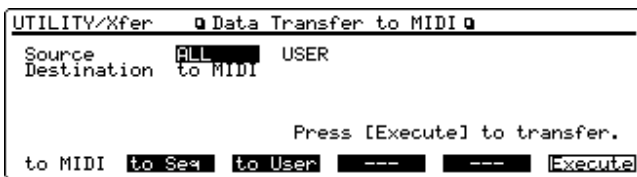

Source

Specifies the data to be transmitted through the combinations as shown below.

For instance, if you want to transmit the settings of Patches 001-032 in USER group, specify "PATCH USER:001-032."

Source			
ALL	USER		1
	TEMP		2
PERFORM	USER	01-32	3
	TEMP	-PATCH	4
		+PATCH	5
	CTRL		6
PATCH	USER	001-128	7
	TEMP		8
RHYTHM	USER	001-002	9
	TEMP		10
SYSTEM	User		11

- 1: All Patches, Performances and Rhythm Sets in USER group
- 2: The current Performance, Patch and Rhythm Set
- 3: The Performance of the specified number in USER group
- 4: The current Performance
- 5: The current Performance and the Patch or Rhythm Set assigned to each Part of the Performance
- 6: The current Performance's Bank Select and Program numbers, as well as Volume and Pan messages of the Parts with the Rx switch ON. Use this selection when you want to make a rough recording of Performance settings balance. Since data is transmitted as controller numbers, the data amount will stay relatively small.
- 7: The Patch of the specified number in USER group

- 8: The current Patch
- 9: The Rhythm Set of the specified number in USER group
- 10: The current Rhythm Set
- 11: System

* Number 6 cannot be selected from Patch mode. In addition, Volume and Pan messages to be transmitted are not part of the selected Performance's data; they are global settings for the entire XP-80 instead. To check the data, use the Part Information display (PERFORM/Info).

Destination

"to MIDI" means that data will be transmitted to an external MIDI device.

<Procedure>

- 1 Make sure that the Utility Menu (UTILITY) is up.
- 2 Press [F6] (Menu) to select Menu 1, then press [F4] (Xfer) to select Data Transfer.

You can also select Data Transfer by moving the cursor to "4 Data Transfer" and pressing [ENTER] on the Utility Menu display (UTILITY), or pressing the numeric key [4], then [ENTER].

- 3 Press [F1] (to MIDI) to call up the Data Transfer to MIDI display (UTILITY/Xfer).
- 4 Move the cursor to "Source" and specify the data you want to transmit.
- 5 Press [F6] (Execute) to transmit the data.

When the data is being transmitted, the display will read "Transmitting..."

* To interrupt data transmission, press [EXIT].

Transmitting data to the internal song

You can transmit Patch, Performance, Rhythm Set or System settings to a specified Song position in a Phrase track or Pattern of the internal song. By recording sound source settings, etc. (Setup data) at the beginning of a song, you can make sure that the song will always play back using the correct Patch or Performance.

* When recording setup data at the beginning of the song, create one blank measure immediately preceding sequencer data and transmit setup data to that portion. If you don't, sequencer data and setup data will overlap and prevent the song from playing back correctly.



Source

Specifies the data to be transmitted through combinations as shown below.

For instance, if you wish to transmit the settings of the current Performance and the Patch or Rhythm Set assigned for each Part, specify “PERFORM TEMP:+PATCH.”

Source			
ALL	USER		1
	TEMP		2
PERFORM	USER	01-32	3
	TEMP	-PATCH	4
		+PATCH	5
	CTRL		6
PATCH	USER	001-128	7
	TEMP		8
RHYTHM	USER	001-002	9
	TEMP		10
SYSTEM	User		11

- 1: All Patches, Performances and Rhythm Sets in USER group
- 2: The current Performance, Patch and Rhythm Set
- 3: The Performance of the specified number in USER group
- 4: The current Performance
- 5: The current Performance and the Patch or Rhythm Set assigned to each Part of the Performance
- 6: The current Performance’s Bank Select and Program numbers, as well as Volume and Pan messages of Parts with the Rx switch ON. Use this selection when you want to make a rough recording of Performance settings balance. Since data is transmitted as controller numbers, the data amount will stay relatively small.
- 7: The Patch of the specified number in USER group
- 8: The current Patch
- 9: The Rhythm Set of the specified number in USER group
- 10: The current Rhythm Set
- 11: System

* Number 6 cannot be selected from Patch mode. In addition, Volume and Pan messages to be transmitted are not part of the selected Performance data; they are global settings for the entire XP-80 instead. To check the data, use the Part Information display (PERFORM/Info).

Destination

“to Seq” means that data will be transmitted to the internal song.

Here you can also specify the Phrase track or Pattern to which the data will be sent, and the Song position (measure-beat-clock) in that track or Pattern. Phrase tracks or Patterns containing no sequencer data cannot be selected.

<Procedure>

- ① Make sure that the Utility Menu (UTILITY) is up.
- ② Press [F6] (Menu) to select Menu 1, then press [F4] (Xfer) to select Data Transfer.

You can also select Data Transfer by moving the cursor to “4 Data Transfer” and pressing [ENTER] on the Utility Menu display (UTILITY), or pressing the numeric key [4], then [ENTER].

- ③ Press [F2] (to Seq) to call up the Data Transfer to Seq display (UTILITY/Xfer).
- ④ Move the cursor to “Source” and specify the data you want to transmit.
- ⑤ Press [▼] to move the cursor and select the Phrase track or Pattern to which you want to transmit data.

You can also select a Phrase track by pressing TRACK/PART [1]–[16].

To select a Pattern, press [PATTERN] and specify the Pattern number.

- ⑥ Press [▶] to move the cursor and specify the Song position in the selected track or Pattern to which data will be transmitted.
- ⑦ Press [F6] (Execute) to transmit the data.

While data is being transmitted, the display will read “Transmitting...”

* To interrupt data transmission, press [EXIT].

Transmitting data to user memory

You can transmit Patch, Performance or Rhythm Set settings to the user memory and System settings to the system memory. By loading sound data from disk or Expansion Boards to user memory, you can add many different sounds to your performance.

* If you wish to transmit an entire data file, use the Load function (Disk/Load).

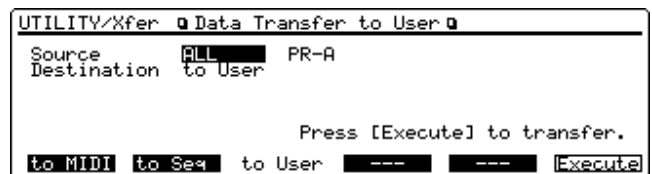

Source

Specifies the data to be transmitted through combinations as shown below.

For instance, if you want to transmit Rhythm Set 001 of the Expansion Board inserted into the XP-80’s EXP-A slot, specify “RHYTHM XP-A:001-001.”

Source			
ALL	PR-A		1
	PR-B		2
PERFORM	USER	01-32	3
	PR-A	01-32	4
	PR-B	01-32	5
	DISK	01: *.SVD 01-32	6
PATCH	USER	001-128	7
	PR-A	001-128	8
	PR-B	001-128	9
	PR-C	001-128	10
	GM	001-128	11
	XP-A	001-	12
	XP-B	001-	13
	XP-C	001-	14
	XP-D	001-	15
	DISK	01: *.SVD 001-128	16
RHYTHM	USER	001-002	17
	PR-A	001-002	18
	PR-B	001-002	19
	PR-C	001-002	20
	GM	001-002	21
	XP-A	001-	22
	XP-B	001-	23
	XP-C	001-	24
	XP-D	001-	25
	DISK	01: *.SVD 001-002	26
SYSTEM	Disk	01: *.SVD	27

- 1: All Patches, Performances and Rhythm Sets in PR-A group
- 2: All Patches, Performances and Rhythm Sets in PR-B group
- 3: The Performance of the specified number in USER group
- 4: The Performance of the specified number in PR-A group
- 5: The Performance of the specified number in PR-B group
- 6: Performances recorded in a data file. To transmit data of a specific Performance only, specify that Performance number.
- 7: The Patch of the specified number in USER group
- 8: The Patch of the specified number in PR-A group
- 9: The Patch of the specified number in PR-B group
- 10: The Patch of the specified number in PR-C group
- 11: The Patch of the specified number in GM group
- 12: The Patch of the specified number in XP-A group
- 13: The Patch of the specified number in XP-B group
- 14: The Patch of the specified number in XP-C group
- 15: The Patch of the specified number in XP-D group
- 16: Patches recorded in a data file. To transmit data of a specific Patch only, specify that Patch number.
- 17: The Rhythm Set of the specified number in USER group
- 18: The Rhythm Set of the specified number in PR-A group
- 19: The Rhythm Set of the specified number in PR-B group
- 20: The Rhythm Set of the specified number in PR-C group
- 21: The Rhythm Set of the specified number in GM group

- 22: The Rhythm Set of the specified number in XP-A group
- 23: The Rhythm Set of the specified number in XP-B group
- 24: The Rhythm Set of the specified number in XP-C group
- 25: The Rhythm Set of the specified number in XP-D group
- 26: Rhythm Sets recorded in a data file. To transmit data of a specific Rhythm Set only, specify that Rhythm Set number.
- 27: System recorded in a data file.

- * It is not possible to select 12-15 or 22-25 when an Expansion Board is not installed into the specified slot (p.45).
- * When 6, 16, 26 or 27 is selected, you can view the list of data files stored on disk by pressing [F5] (List). To select a data file from the list, move the cursor to the desired data file and press [F6] (Select) or [ENTER].



Destination

“to User” means that data will be transmitted to user memory.

You can also specify the destination number at this point.

- * If 1, 2 or 27 is selected for the Source parameter, it is not possible to specify the destination number.

<Procedure>

- 1 Make sure that the Utility Menu (UTILITY) is up.
- 2 Press [F6] (Menu) to select Menu 1, then press [F4] (Xfer) to select Data Transfer.

You can also select Data Transfer by moving the cursor to “4 Data Transfer” and pressing [ENTER] on the Utility Menu display (UTILITY), or pressing the numeric key [4], then [ENTER].

- 3 Press [F3] (to User) to call up the Data Transfer to User display (UTILITY/Xfer).
- 4 Move the cursor to “Source” and specify the data you want to transmit.
- 5 Move the cursor to “Destination” and specify the transmission destination number.
- 6 Press [F6] (Execute) to transmit the data.

While data is being transmitted, the display will read “Transmitting...”

- * To interrupt transmission of data from disk, press [EXIT].

Preventing user memory writing operation – 5 Protect (User memory protect)

This function prevents user memory from being rewritten to ensure Patch, Performance or Rhythm Set data will not accidentally be lost.

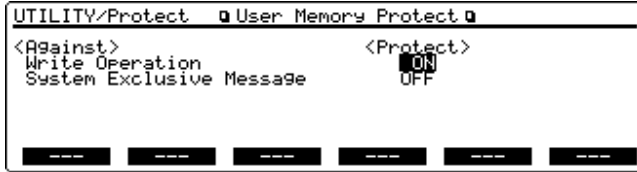

Write Operation

This prevents the Write operation from rewriting user memory. When this setting is ON, the data cannot be rewritten. Data can be rewritten only if it is OFF. When the XP-80's power is turned on, this setting is always ON, so you will need to set it OFF before rewriting user memory settings. It is also possible to set this OFF as part of the Write operation or Factory Preset operation.

System Exclusive Message

This prevents incoming System Exclusive messages from an external MIDI device from rewriting user memory settings. When this is set ON, the data cannot be rewritten. Data can be rewritten when it is OFF.

- * If this parameter is OFF, data can be rewritten by an incoming System Exclusive message even if the Write Operation parameter setting is ON.

<Procedure>

- 1 Make sure that the Utility Menu display (UTILITY) is up.
- 2 Press [F6] (Menu) to select Menu 1, then press [F5] (Protect) to select User Memory Protect.

You can also select User Memory Protect by moving the cursor to "5 Protect" and pressing [ENTER] on the Utility Menu display (UTILITY), or pressing the numeric key [5], then [ENTER].

- 3 Move the cursor to "Write Operation" and specify ON or OFF.
- 4 Move the cursor to "System Exclusive Message" and specify ON or OFF.

Erasing the internal song – 6 Song Init (Song initialize)

This function clears the internal song in the internal memory. It is used before recording a new song.

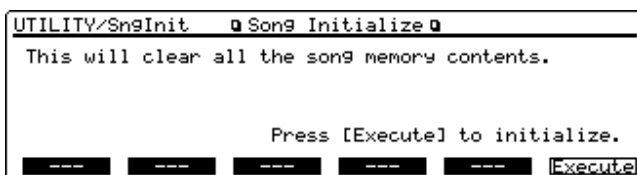

<Procedure>

- 1 Make sure that the Utility Menu display (UTILITY) is up.
- 2 Press [F6] (Menu) to select Menu 2, then press [F1] (SngInit) to select Song Initialize.

You can also select Song Initialize by moving the cursor to "6 Song Init" and pressing [ENTER] on the Utility Menu display (UTILITY), or pressing the numeric key [6], then [ENTER].

- 3 Press [F6] (Execute) to perform song initialization.

When song initialization is completed, the Play display (SEQ) appears.

Checking internal memory consumption – 7 Memory Info (Internal memory information)

This function lets you check the amount of data stored in internal memory. Repeating track editing or quantization processes will create data nonessential for playback of the internal song. Erase such data with the Data Reduce function.

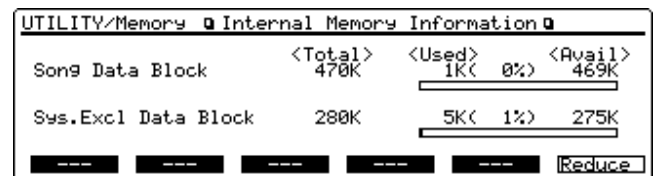

Song Data Block

Displays the amount of the internal song data.

<Total> shows the maximum memory data capacity, <Used> the amount of memory used for current data, and <Avail> the memory amount available for use.

A graphic display will also appear for reference.

Sys. Excl Data Block (System exclusive message data block)

Displays the amount of the System Exclusive message data in the internal song. If the internal song contains large amounts of System Exclusive message data, it may prevent recording or undo operations.

<Total> shows the maximum memory data capacity, <Used> the amount of memory used for the current data, and <Avail> the memory amount available for use.

A graphic display will also appear for reference.

<Procedure>

- 1 Make sure that the Utility Menu display (UTILITY) is up.
- 2 Press [F6] (Menu) to select Menu 2, then press [F2] (Memory) to select Internal Memory Information.

You can also select Internal Memory Information by moving the cursor to "7 Memory" and pressing [ENTER] on the Utility Menu display (UTILITY), or pressing the numeric key [7], then [ENTER].

- 3 Check the amount of internal memory used on the Internal Memory Information display (UTILITY/Memory).

.....
<Data Reduce>

The Data Reduce function erases data nonessential for playback to save memory. This function is useful when an error message such as "Internal Memory Full" is displayed.

- * After a Data Reduce function execution, you cannot undo the procedure.

<Procedure>

- ❶ Make sure that the Internal Memory Information display (UTILITY/Memory) is up.
- ❷ Press [F6] (Reduce).

A window shows a prompt to confirm you really want to execute.

- ❸ Press [F5] (OK) to reduce data. To cancel data reducing, press [F6] (Cancel).
-

Recalling factory default settings – 8 Factory (Factory preset)

This function resets all the settings stored in the XP-80 memory to the factory default settings. Internal memory and chain settings will also be discarded.

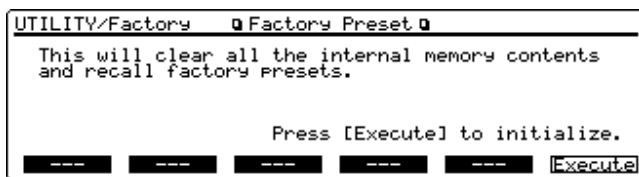

<Procedure>

- ❶ Make sure that the Utility Menu display (UTILITY) is up.
- ❷ Press [F6] (Menu) to select Menu 3, then press [F1] (Preset) to select Factory Preset.

You can also select Factory Preset by moving the cursor to "8 Factory" and pressing [ENTER] on the Utility Menu display (UTILITY), or pressing the numeric key [8], then [ENTER].

- ❸ Press [F6] (Execute) to perform Factory Preset operation.

After performing Factory Preset operation, the Play display (PATCH) appears.

- * If you execute Factory Preset operation with the Write Operation parameter ON, a window shows "Write Protect ON." Reset the parameter OFF to perform Factory Preset operation. After setting is completed, press [EXIT] or [ENTER] to close the window. Then press [F6] (Execute) to perform the operation again. Once you set it OFF, the Write Operation parameter will remain OFF until you turn the power off.

Chapter 9. Disk-related functions (Disk mode)

Disk mode performs disk-related functions such as loading data from disk into the XP-80's memory (Load), and saving a song or sound source settings to disk (Save). You can also format a disk or create a backup disk in this mode.

<Before operating in Disk mode>

To perform any operation in Disk mode, a 3.5" 2DD/2HD disk is required.

Before using a new disk or one that has been used on another device, please initialize (format) it on the XP-80. A 3.5" 2DD disk should be formatted to 720KB and 3.5" 2HD disk to 1440KB. These are standard formats used with most song data software and computers/instruments. If you save a song created on the XP-80 as a Standard MIDI File, you can use many devices to play your song.

About Disk mode

Simply press [DISK] to select the mode and make the indicator light.

Disk mode offers nine functions categorized into three groups – Menu 1–Menu 3.

Menu 1

Load

This function loads data from disk into the XP-80's memory.

Save

This function saves data to disk.

Format

This formats a disk.

Backup

This creates a backup disk.

Verify

This function checks files on disk to make sure that they are not corrupted.

Menu 2

Volume (Change volume label)

This assigns a new volume label to a disk.

Delete (Delete file)

This function deletes unwanted files from disk.

Rename

This assigns a new name to a file on disk.

Menu 3

Info (Disk information)

This function displays the number of files on disk and the remaining free disk memory.

(Basic Procedure)

- 1 Insert a disk into the disk drive.
- 2 Press [DISK] to call up the Disk Menu display (DISK).

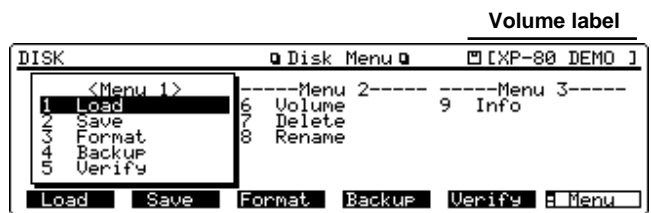

- 3 Press [F6] (Menu) to select the menu containing the function you want.

Each time [F6] (Menu) is pressed, the selection will cycle through Menu 1, Menu 2 and Menu 3, back to Menu 1 and so on.

- 4 Press any button from [F1] to [F5] to select the function you want. The display of the function you've selected will appear.

* The desired function can be selected by pressing [INC]/[DEC] or cursor buttons, or turning the VALUE dial to move the cursor, and pressing [ENTER] on the Disk Menu display (DISK). You can also select a function by inputting a number corresponding to the function. Use the numeric keys and press [ENTER] on the Disk Menu display (DISK) to enter it.

- 5 Set parameters as necessary on each function's display.

* To cancel the operation, press [EXIT].

- 6 Press [F6] (Execute) to execute operation.

When the operation is completed, a window will show "COMPLETE" momentarily.

- 7 To return to the Disk Menu display (DISK), press [EXIT]. To return to the original mode display, press [DISK].

<Displaying the file list>

When Load, Save, Delete File, Rename or Disk Information is selected, you can view the list of files on disk. This is called a 'File List window.' The File List window shows up to seven files at once in alphabetical order for each file type. Locating the file you want is easy.

<Procedure>

- 1 On the Load, Save, Delete File, Rename, or Disk Information display, press [F5] (List) to display the File List window.



The cursor is positioned at the current file.

- 2 To change the type of file to be displayed, press [F2]–[F5].

The type of file to be displayed varies depending on the File Type parameter setting.

- 3 Press [▲], [▼], [INC] or [DEC], or turn the VALUE dial to move the cursor to the desired file. You can also move the cursor by specifying file number with a numeric key.

As the file selection has not been finalized yet, the song number and file name will be boxed.

- * A ▲ mark or ▼ mark will appear at the display upper left or lower left. This indicates there are more files that cannot fit the current display window. To view those files, move the cursor to the bottom file and press [▼] or [INC]. To view the preceding files, move the cursor to the top file and press [▲] or [DEC].
- ④ Press [F6] (Select) or [ENTER] to finalize the file selection.

The File List window will close.

- * To close the File List window without finalizing the file selection, press [EXIT].

Loading a file from disk into the XP-80 – 1 Load

This function loads a song on disk into the internal memory. As the XP-80 loads MRC Pro songs as well as Standard MIDI Files and S-MRC format songs, it copes efficiently with different song data. And with MRC Pro songs, a Phrase track or Pattern can be specified for loading. A complete song can therefore be created by combining different MRC Pro song data. Besides songs, you can also load data files or chain files into internal memory.

- * Loading a new file will rewrite data currently resident in memory. To keep existing data, save it to disk before loading new data.

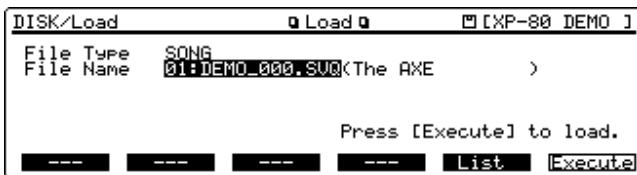

File Type

Selects the type of file you want to load.

SONG: Loads an MRC Pro song or Standard MIDI File into internal memory.

TRACK: Loads a specified Phrase track or Pattern extracted from an MRC Pro song into the Phrase track or Pattern you specify in internal memory.

S-MRC: Converts an S-MRC format song created on an MC-50, etc. into an MRC Pro song and loads it into internal memory.

SOUND: Loads Patches, Performances and Rhythm Sets into user memory, and System data into system memory.

CHAIN: When the XP-80 sequencer is in chain play mode, a chain file containing chain play settings will be loaded into XP-80.

- * When the XP-80's sequencer is in chain play mode, only CHAIN or SOUND can be selected. SOUND cannot be selected when GM mode is chosen.
- * When SOUND is selected, the entire data file will be loaded. If you wish to load a specific Performance, Patch or Rhythm Set, use the Data Transfer function (UTILITY/Xfer/Transfer to User).

File Name

Selects the file to be loaded.

If SONG or TRACK is selected for the File Type parameter, the song name will appear in parentheses ().

<Procedure>

- ① Make sure that the Disk Menu display (DISK) is up.
- ② Press [F6] (Menu) to select Menu 1, then [F1] (Load) to call up the Load display (DISK/Load). This display can also be called up by moving the cursor to "1 Load" and pressing [ENTER] on the Disk Menu display (DISK), or pressing the numeric key [1] then [ENTER].
- ③ Move the cursor to "File Type" and select the type of file to be loaded.

If the File List window is up, you can select the desired file by pressing a button from [F2] (Song)–[F5] (Sound). This will also change the file shown in the File List window.

- * If TRACK has been selected, you'll choose the Phrase track or Pattern for extracting and the loading destination (internal memory) Phrase track or Pattern. You can also select TRK1–TRK16 by pressing TRACK/PART[1]–[16]. You can also select PTN001–PTN100 by pressing [PATTERN] and specifying a Pattern number.

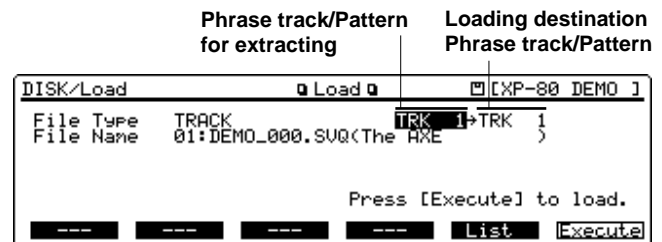

- ④ Move the cursor to "File Name" and select the file you want to load.

To select a file in the File List window, press [F5] (List).

- ⑤ Press [F6] (Execute) to load data.

<Auditioning a Phrase track or Pattern>

With MRC Pro songs, it is possible to extract a specific Phrase track or Pattern and load it into internal memory. Here you can audition the Phrase track or Pattern to be extracted.

Pressing [STOP/PLAY] before executing loading will play back only the current Phrase track or Pattern.

- * It may take some time before playback begins.
- * If the specified Phrase track or Pattern contains mode settings, the Utility mode will disengage, making it impossible to continue auditioning from that point.

.....
 <Combining two songs into one>

First load the song to be used for the first half into internal memory. For the song that will be used for the second half, set the File Type parameter to TRACK, then load each Phrase track into a Pattern. Then assign a Pattern to a Phrase track using step recording or perform track editing to complete a song.

Saving data to disk – 2 Save

This function saves a song stored in internal memory (internal song), Patch, Performance or Rhythm Set settings, or a data file containing System settings to disk.

- * Data cannot be saved to the master disks of Standard MIDI File releases, etc. from Roland.
- * Song data with copyrighted information cannot be re-saved in the Standard MIDI File format.
- * When saving data in Standard MIDI File format, Pattern track and muted Phrase track data will not be saved. However, Pattern Call messages recorded on a Phrase track will be converted into actual sequencer data as they are saved.



File Type

Selects the file saving format.

SONG: Saves song in internal memory to disk in the MRC Pro song format. The file name extension “.SVQ” is automatically attached.

Please also specify whether you also want to save the settings of the current Patch/Performance/Rhythm Set using the Save Mode parameter.

SMF-0: Converts a song in internal memory to Standard MIDI File format 0 data (one Phrase track contains the entire sequencer data) and saves it to disk. The file name extension “.MID” is automatically attached.

SMF-1: Converts a song in internal memory to Standard MIDI File format 1 data (sequencer data consists of two or more Phrase tracks) and saves it to disk. The file name extension “.MID” is automatically attached.

SOUND: Saves Patches, Performances, Rhythm Sets, and System data as a data file. The file name extension “.SVD” is automatically attached.

CHAIN: When the sequencer is in chain play mode, chain play settings will be saved to disk as a chain file. The file name extension “.SVC” is automatically attached.

- * When the XP-80’s sequencer is in chain play mode, only CHAIN or SOUND can be selected. SOUND cannot be selected when GM mode is chosen.

- * The file name extension “.MID” is automatically attached regardless whether data is saved in SMF-0 or SMF-1 format. These two formats cannot be distinguished through file name extension.

Save Mode

This parameter will be specified only if you’ve selected SONG for the File Type parameter. If you want to save only the song, specify SONG ONLY. If you want to save current sound settings along with the song, specify SONG+SOUND.

- * The file name extension “.SVQ” is automatically attached regardless whether data is saved as SONG ONLY or SONG+SOUND. These two cannot be distinguished through file name extension.
- * When SONG+SOUND is selected, the settings of the Patch or Rhythm Set assigned to each Part of the Performance will not be saved.
- * When SONG+SOUND is selected, sound settings at the time of saving will be saved. If you change the sound in the middle of a song and save the song after recording, the settings at the recording start will not be saved. So if you play back the song from its beginning, it will play back using the existing sound settings at the moment of saving. To avoid this, when you’ve changed the sound in the middle of a song, record the Bank Select and Program numbers (corresponding to the sound selected when recording started) at the beginning of the song on the Microscope display (SEQ/Micro), etc.
- * Data saved with SONG+SOUND selected for the Save Mode parameter will not play back with the correct sound on an MRC Pro sequencer other than the XP-80. To play it back with correct sound, record the corresponding Bank Select and Program numbers.

File Name

Assigns a file name (using up to eight alphanumeric characters).

If SONG, SMF-0 or SMF-1 is selected for the File Type parameter, the song name will appear in parentheses (). A song name cannot be assigned on this display.

If a song name has already been assigned, the first eight characters of the song name will automatically be assigned for the file name. If no song name is assigned, “SONG_000” will be automatically be assigned for the file name. A sound file and chain file will automatically be named “SOUND_00” and “CHAIN_00,” respectively.

.....
 <File names and song names>

MRC Pro songs and Standard MIDI Files have song names in addition to file names. The file name is used to distinguish the file on disk, and must be specified before the file can be saved. You’ll find it easier to manage your data if you use a file name that indicates song type, and a song name that actually names the song. Use the Song Name display (SEQ/Setup/SngName) to assign a song name.

<Procedure>

- ❶ Make sure that the Disk Menu display (DISK) is up.
- ❷ Press [F6] (Menu) to select Menu 1, then [F2] (Save) to call up the Save display (DISK/Save).
This display can also be called up by moving the cursor to "2 Save" and pressing [ENTER] on the Disk Menu display (DISK), or pressing the numeric key [2] then [ENTER].
- ❸ Move the cursor to "File Type" and select the desired format for saving data.

If the File List window is up, you can select the desired data format by pressing a button from [F2] (Song)–[F5] (Sound). This will also change the file shown in the File List window.

- * If SONG has been selected, move the cursor to "Save Mode" and specify whether you want to save sound settings along with the song.
- ❹ Move the cursor to "File Name" and name the file whatever you like.

If you want to name the file in the Name window, press [F1] (Name).

To select a file in the File List window, press [F5] (List).

- ❺ Press [F6] (Execute) to save data.
- * If you try to save a file with a pre-existing name, a window asks "File Name duplicate. Overwrite?" To rewrite the file, press [F5] (OK). To cancel saving, press [F6] (Cancel).
- * When you try to save data to a disk which has not been formatted for the XP-60/XP-80, a window asks "Unformatted disk. Format?" When formatting the disk, press [F5] (OK). If you decide not to format the disk, press [F6] (Cancel).

- then [ENTER].
- ❻ Assign the name you want (volume label) to the disk. When assigning the volume label in the Name window, press [F1] (Name).
- * It is not always necessary to assign a volume label to a disk. But since volume label of the disk appears at the display upper right on the Play display (SEQ(Song)) or in Disk mode, it is recommended that you assign a volume label to quickly confirm the disk inserted in the disk drive.
- * To modify the volume label, use the Change Volume Label function.
- ❼ Press [F6] (Execute) to format the disk.
A window will ask "Format. OK?"
- ❽ To format the disk, press [F5] (OK).
If you decide not to format the disk, press [F6] (Cancel).

Formatting the disk for the XP-60/XP-80 – 3 Format

This function initializes (formats) a disk so that XP-60/XP-80 data can be saved to it. Before a new disk or a disk used on another device can be used on the XP-60/XP-80, it must be formatted on the XP-60/XP-80.

- * Please be aware that formatting will erase all the data already resident on the disk.
- * Master disk releases of Standard MIDI Files from Roland, etc. cannot be formatted.

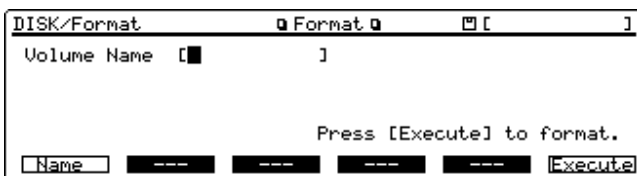

<Procedure>

- ❶ Make sure that the Disk Menu display (DISK) is up.
- ❷ Press [F6] (Menu) to select Menu 1, then [F3] (Format) to call up the Format display (DISK/Format).
This display can also be called up by moving the cursor to "3 Format" and pressing [ENTER] on the Disk Menu display (DISK), or pressing the numeric key [3]

Making a copy of a disk – 4 Backup

This function creates a complete copy of all data recorded on a disk and puts it on another disk. It is a good idea to make backup copies of disks containing important data to prevent data loss even if one of the disks should be damaged.

- * Backup operation uses internal memory. If you wish to keep the song data currently in internal memory, save it to disk before executing the backup operation.
- * It is not possible to make a backup copy of the master disk of Standard MIDI Files releases, etc. from Roland.
- * It is not possible to create a backup copy of a 2DD disk on a 2HD disk, and vice versa.

<Procedure>

- ① Make sure that the Disk Menu display (DISK) is up.
- ② Press [F6] (Menu) to select Menu 1, then [F4] (Backup) to call up the Backup display (DISK/Backup). This display can also be called up by moving the cursor to “4 Backup” and pressing [ENTER] on the Disk Menu display (DISK), or pressing the numeric key [4] then [ENTER].



- ③ To avoid accidentally writing to the backup source disk, set the protect tab to protect, and insert it into the disk drive.
- ④ Press [F6] (Execute).

A window will ask “Clear Internal Song for BACKUP. OK?”

- ⑤ If you are sure that you want to erase the internal song to perform backup, press [F5] (OK).

Data from the backup source disk will be loaded into internal memory.

To cancel the backup operation, press [F6] (Cancel).

- ⑥ After a while, the display will show “Insert Destination Disk.” When this display appears, remove the backup source disk and insert the backup destination disk.

Use a disk formatted on the XP-80 as the backup destination disk and set protect tab to write before inserting it into the disk drive.

- ⑦ Press [F6] (Execute) to make a backup copy.

Data will be written to the backup destination disk.

- * If you insert a disk which has not been formatted for the XP-80 into the disk drive, a window asks “Unformatted disk. Format?” When formatting the disk, press [F5] (OK). If you decide not to format the disk, press [F6] (Cancel).

- * If you insert a 2DD disk when the backup source disk is 2HD, or vice versa, the display will show “Different formatted disk.” Insert a disk of the same type and press [ENTER].

- ⑧ After a while, the display will show “Insert Source Disk.” When this display appears, remove the backup destination disk and insert the backup source disk into the disk drive.

When the disk is exchanged, data will continue to be loaded into internal memory.

- ⑨ When the display shows “Insert Destination Disk” it’s time to remove the backup source disk and insert the backup destination disk.

When the disk is exchanged, data will continue to be saved on disk.

- ⑩ Repeat steps 8 and 9.

The frequency of repeating steps depends on the amount of data on disk.

- ⑪ When “Backup Complete” is displayed, backup has been completed.

Checking files recorded on disk – 5 Verify

If a disk is scratched, slightly bent or damaged in some way, song data or sound data files on it will no longer be readable, and functions such as quick play and chain play will be interrupted. To avoid such problems, this function checks all the files on disk to see whether they can be read correctly.



<Procedure>

- ① Make sure that the Disk Menu display (DISK) is up.
- ② Press [F6] (Menu) to select Menu 1, then [F5] (Verify) to call up the Verify display (DISK/Verify). This display can also be called up by moving the cursor to “5 Verify” and pressing [ENTER] on the Disk Menu display (DISK), or pressing the numeric key [5] then [ENTER].
- ③ Press [F6] (Execute) to verify the disk.

If the disk is verified normal, the display will indicate “COMPLETE.” If a problem is found, the display will indicate “Disk Read/Write Error.”

Changing the name of disk – 6 Volume (Change volume label)

This function changes the volume label that was assigned when the disk was formatted.

- * It is not possible to modify the volume label of the master disks of the Standard MIDI Files releases, etc. from Roland.



<Procedure>

- ❶ Make sure that the Disk Menu display (DISK) is up.
- ❷ Press [F6] (Menu) to select Menu 2, then [F1] (Volume) to call up the Volume display (DISK/Volume). This display can also be called up by moving the cursor to “6 Volume” and pressing [ENTER] on the Disk Menu display (DISK), or pressing the numeric key [6] then [ENTER].
- ❸ Assign a new volume label.

When you assign a new volume label in the Name window, press [F1] (Name).

- ❹ Press [F6] (Execute) to assign a new volume label.

Deleting unwanted files – 7 Delete (Delete file)

Use this function to delete unwanted files from disk.

- * Master disks of Standard MIDI Files releases, etc. from Roland cannot be deleted.

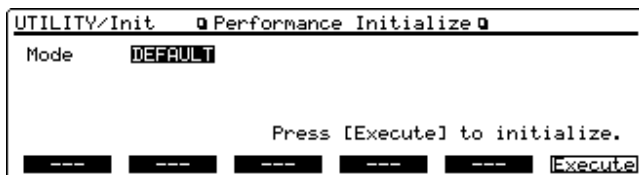

File Type

Selects the type of file you wish to delete.

SONG: Deletes an MRC Pro song or Standard MIDI File.

FILE: Deletes file types other than those listed above.

File Name

Selects the file you want to delete by specifying the file number.

If SONG is selected for the File Type parameter, the song name will appear in parentheses ().

<Procedure>

- ❶ Make sure that the Disk Menu display (DISK) is up.
- ❷ Press [F6] (Menu) to select Menu 2, and [F2] (Delete) to call up the Delete display (DISK/Delete). This display can also be called up by moving the cursor to “7 Delete” and pressing [ENTER] on the Disk Menu display (DISK), or pressing the numeric key [7] then [ENTER].
- ❸ Move the cursor to “File Type” and select the type of file to be deleted.

If the File List window is up, you can select the desired file by pressing [F2] (Song) or [F3] (File). This will also change the file shown in the File List window.

- ❹ Move the cursor to “File Name” and select the file you want to delete.

To select a file in the File List window, press [F5] (List).

- ❺ Press [F6] (Execute) to delete the file.

A window will ask “Delete OK?”

- ❻ To delete the file, press [F5] (OK). To cancel deleting, press [F6] (Cancel).

Renaming a file – 8 Rename

This function changes the name of a file.

- * File name extensions cannot be changed.
- * Files on the master disks of the Standard MIDI File releases, etc. from Roland cannot be renamed.

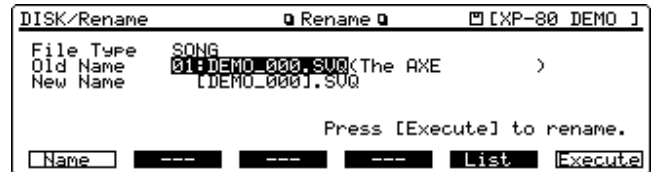

File Type

Selects the type of file you wish to rename.

SONG: Renames an MRC Pro song file or Standard MIDI File.

FILE: Renames file types other than those listed above.

Old Name (Old file name)

Selects the file name you want to modify.

If an MRC Pro song or Standard MIDI File is selected for the File Type parameter, the song name will appear in parentheses ().

New Name (New file name)

Assigns a new file name.

<Procedure>

- ❶ Make sure that the Disk Menu display (DISK) is up.
- ❷ Press [F6] (Menu) to select Menu 2, then [F3] (Rename) to call up the Rename display (DISK/Rename). This display can also be called up by moving the cursor to “8 Rename” and pressing [ENTER] on the Disk Menu display (DISK), or pressing the numeric key [8] then [ENTER].
- ❸ Move the cursor to “Old Name” and select the file name you want to modify.

If the File List window is up, you can select the desired file by pressing [F2] (Song) or [F3] (File). This will also change the file shown in the File List window.

- ❹ Move the cursor to “New Name” and assign the new name.

To assign a new name to the file in the Name window, press [F1] (Name).

- ❺ Press [F6] (Execute) to rename the file.

A window will ask “Rename OK?”

- ❻ To rename the file, press [F5] (OK). To cancel renaming, press [F6] (Cancel).

Checking the contents of disk – 9 Info (Disk information)

This function displays the number of files on the disk, the free area of the disk, and the size of each file.

DISK/Info		Disk Information		[XP-80 DEMO]	
Song File	20files	Disk Capacity			
Sound File	0files	1010KB Free/1423KB			
Chain File	1files				
Groove File	1files				
Total	23files				
List					

Song File

Displays the number of songs on the disk (MRC Pro songs and Standard MIDI Files).

Sound File (Data file)

Displays the number of data files on the disk.

Chain File

Displays the number of chain files on the disk.

Groove File (User groove template file)

Displays the number of user template files on the disk.

Total

Displays the total number of all files on the disk.

- * The Total does not indicate the total number of Song Files through Groove Files, above. To save the song to disk with the XP-80, the information regarding that song will be stored in the "SONGLIST.SV" file. The Total includes this file too, but this file cannot be checked from the XP-80.

Disk Capacity

The available memory of the disk will be shown to the left of Disk Capacity and the total disk capacity to the right.

<Procedure>

- ❶ Make sure that the Disk Menu display (DISK) is up.
- ❷ Press [F6] (Menu) to select Menu 3, then [F1] (Info) to call up the Disk Information display (DISK/Info).
This display can also be called up by moving the cursor to "9 Info" and pressing [ENTER] on the Disk Menu display (DISK), or pressing the numeric key [9] then [ENTER].
- ❸ To check the size of each file, press [F5] (List) to open the File List window.

DISK/Info		Disk Information		[XP-80 DEMO]	
Song File	01: DEMO_000.SUQ<The AXE >	43KB			
Sound File	02: DEMO_001.SUQ<New Age Express>	53KB			
Chain File	03: DEMO_002.SUQ<Sound Pile /#4 >	63KB			
Groove File	04: DEMO_003.SUQ<Ten Years >	46KB			
Total	05: DEMO_004.SUQ<Saga >	24KB			
	06: DEMO_005.SUQ<Body Noise >	38KB			
	07: DEMO_006.SUQ<RPS City >	35KB			
List					

To change the file on display, press [F2] (Song) or [F3] (File).

To check an MRC Pro song or Standard MIDI file, press [F2] (Song). When checking other file types, press [F3] (File).

Chapter 10. Using the XP-80 as the GM sound source

The XP-80 features a GM mode – a convenient way to play back or create GM score data (music data for GM sound sources). You're able to play back commercial GM score data releases and even modify various parameter settings for enhanced musical expression.

Entering GM mode

Use GM mode to place the XP-80's sound source in GM System compatible mode. Basically GM mode is similar to a special kind of Performance in which a GM System Rhythm Set is assigned to Part 10, and GM System Patches are assigned to other Parts. But however, you can't store GM mode settings in user memory.

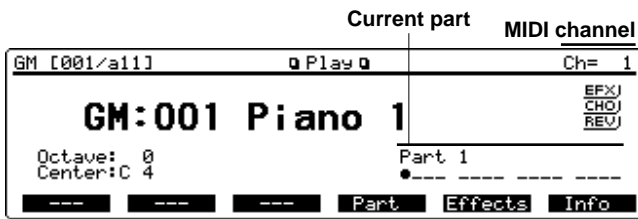

The Play display (GM) shows a Patch or Rhythm Set assigned to each Part. Each time you enter GM mode, the GM Drum Set is assigned to Part 10, and Piano 1 is assigned to other Parts. You can also select other GM Patches and GM Drum Sets for each Part to match the performance.

<Procedure>

- ❶ Hold down [SHIFT] and press [PERFORM] to call up the Play display (GM).

When you switch the XP-80 into GM mode, the sound source initializes itself for basic GM System settings.

- ❷ To change the current Part, press [◀] or [▶].
- ❸ To change the GM Patch or GM Rhythm Set assigned to the Part, perform the same procedure as you do when you select a Patch or Rhythm Set.

Initializing the sound source for GM System basic settings

To play back a GM score correctly, the sound source must first be initialized to basic GM system settings. The XP-80's sound source is initialized in the following situations:

- When the XP-80 is switched to GM mode
- When it receives a GM System On message from an external MIDI device
- When a GM System On message is encountered in the song data being played back
- At power on
- When you execute the GM Initialize function (p.176).

- * Because effects settings are not defined in the GM System, they will not initialize to factory settings unless the GM Initialize (DEFAULT) or Factory Preset is executed.

.....
<GM System On message>

The GM System On message puts the unit in a state that conforms to the GM System and initializes a GM-compatible sound source.

- * If the Rx GM-ON Message parameter (SYSTEM/MIDI Param2) is set OFF, GM System On messages cannot be received.

Playing back a GM score

When the XP-80 is in GM mode, it plays back GM scores correctly. But beyond this, the XP-80 provides many extended features not defined in GM System specifications, and if you create music data using these extended features, your song may not play back correctly on other GM-compatible sound sources.

- * The XP-80 is not compatible with the GS format (standard format for multitimbral sound sources advocated by Roland). Music data bearing the GS logo (GS music data) may therefore not play back correctly on the XP-80.

<Procedure>

- ❶ Hold down [SHIFT] and press [PERFORM] to switch the XP-80 into GM mode.
- * The beginning of a GM score normally contains a GM System On message. So if you play back a GM score starting in the top of a song, XP-80 will switch itself to GM mode. But if you play back a GM score starting in the middle of a song, XP-80 may not switch itself to GM mode, and the GM score may not play back correctly. So to be safe, it's recommended to manually set the XP-80 to GM mode before playing back a GM score.
- ❷ Press [SEQUENCER] to call up the play display (SEQ(Song)).
- ❸ Move the cursor to the song number and select the number of the song you wish to play back.
- ❹ Press [STOP/PLAY] to begin play back.

When the song ends, playback will stop automatically. To interrupt play back, press [STOP/PLAY].

- * The procedure for playing back a GM score is the same as for playing back a regular song. If you wish to modify the playback tempo or to playback the song repeatedly, refer to "Playing back a song" (p.97). Recording and editing a GM score is also the same way as for a regular song (p.104–, 117–).

Muting a specific Part

When you switch over to GM mode, all Parts will be set to receive MIDI messages. To turn off a specific Part so that it will not sound, set the Rx Switch parameter to OFF for the Part.

<Procedure>

- ❶ Press [LOCAL/TX/RX] to open the LOCAL/TX/RX window.
- ❷ Press TRACK/PART [1]–[16] to switch each Rx Switch parameter for the Part ON (indicator lit) or OFF (indicator off).

The Parts set ON are indicated with "o," and those set OFF are indicated with "-."

Modifying GM mode settings

GM mode also offers parameters that you can modify for each Part. You can modify settings like effects, pan and level to customize a GM score playback to your preference.

<Procedure>

- ❶ With the Play display (GM) showing, press [F4] (Part)–[F6] (Info) to select the display group you want.
- ❷ If you have selected Effects group or Info group, press [F1]–[F6] to call up the display page you want.
- ❸ If you have pressed [F3] (Part) in step 1, press TRACK/PART [1]–[16] to select the Part you want to edit.
- ❹ Move the cursor to the parameter you want to modify.
- ❺ Use the VALUE dial, [INC]/[DEC] or numeric keys to specify the value.
- * If you've made a mistake in setting the parameter value or you don't like the changes, press [UNDO/REDO] to restore the original value to what it was.
- ❻ Repeat steps 1–5 to complete GM mode settings.
- ❼ After you finish making settings, press [EXIT] to return to the Play display (GM).
- * You can also use the Palette display in the same manner when you edit in Performance mode.

Setting a Part (Part)

Part Param (Part parameter) display

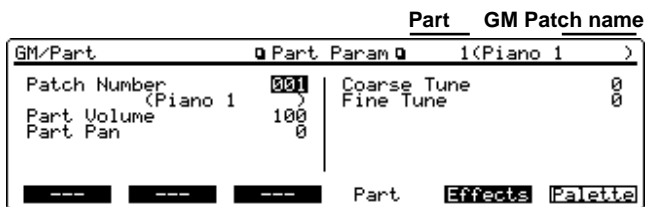

Patch Number (GM Patch number)

Select the number of the GM Patch assigned to each Part (GM Rhythm Set is assigned to Part 10). GM Patch names are indicated in parentheses ().

- * To display the GM Patch list (GM Rhythm Set for Part 10), press [SOUND LIST].
- * You cannot select Patches from Patch groups USER and PRESET A–C.

Part Volume

Set the volume for each Part. This parameter is mainly used to adjust volume balance between Parts.

Part Pan

Adjusts panning for each Part. L64 is hard left, 0 is center, and 63R is hard right.

- * If Part Volume parameter or Part Pan parameter settings are modified, they will reflect in the Volume and Pan items on the Part Information display.

Coarse Tune

Adjusts the reference pitch of each Part in semitone steps (-4– +4 octaves). The pitch will change relative to the pitch of the GM Patch (0).

Fine Tune

Makes fine adjustments over -50– +50 cents in 1-cent steps (1/100th of a semitone) for the pitch specified in Coarse Tune for the Part.

Making effects settings in GM mode (Effects)

Parameter configurations of GM effects and Patch effects are almost the same. For details refer to “Setting effects for a Patch” (p.60).

- * When making effects settings for a Performance, follow the procedure in “Routing effects” and substitute Part for Tone. (p.60)

<About effects for GM-compatible sound sources>

Most GM-compatible sound sources provide effects such as chorus and reverb, but using effects is not a part of the GM System Level 1 guidelines. This means that song data created for the XP-80's GM mode using EFX, Reverb and Chorus may not play back correctly on other GM-compatible sound sources.

In this section only the parameters that differ from Patch effects (General display) are discussed.

General (Effects general) display

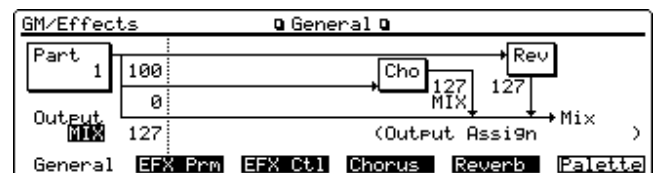

Output Assign

Specifies how each Part will be output.

MIX: The direct sound will be output from the MIX OUTPUT. If Chorus and/or Reverb are selected, these effects will be output together with the direct sound.

EFX: The direct sound will be sent to the EFX. The sound that passes through the EFX will be output as specified by the EFX OUTPUT Assign parameter.

DIR: Only the direct sound will be output from the DIRECT OUT. If Chorus and/or Reverb are selected, these effects settings will have no effect.

PAT: The direct sound will be output as specified by the Output Assign parameter for the GM Patch assigned to the Part. The Output Assign, Output Level, Chorus Send Level and Reverb Send Level parameter settings will be multiplied by the settings of GM Patch.

MIX/EFX Send Level

Specifies the volume of each Part.

If EFX is selected for Output Assign parameter, higher values will increase EFX'd sound volume. If MIX or DIRECT is selected, higher values will increase direct sound volume.

Chorus Send Level

Adjusts the amount of chorus to be applied to each Part.

- * If DIR is selected for the Output parameter, this value cannot be specified because chorus will not be applied to the sound.

Reverb Send Level

Adjusts the intensity of reverb to be applied to each Part.

- * If DIR is selected for the Output parameter, this value cannot be specified because reverb will not be applied to the sound.

Confirming MIDI information of each Part (Info)

- * With the Arpeggiator on, closing the Arpeggio window in the Play display (GM) will assign the function to re-open the Arpeggio window to [F6]. To call up the Part Information display, hold down [SHIFT] as you press [F6].

Part Info (Part information) display

On this display you can confirm the receive status of various types of MIDI messages for 16 Parts all at once. This is convenient for making sure the sound source is responding correctly to messages from the keyboard, sequencer or external MIDI controllers.

- * To reset the values shown on the Part Information display to the standard values, hold down [SHIFT] as you press [EXIT].

Voices : [F5] (Voices)

The number of voices

.....

<MIDI message transmission>

When you modify a value shown on the Part Information display (excluding Voice), the MIDI message of the modified value will be transmitted to the current Part, and to the XP-80's sequencer or external MIDI devices on that Part's MIDI channel simultaneously.

<Transmitting MIDI messages using the Sound Palette>

With the Sound Palette's four sliders, you can transmit each Modulation through System Control 2 MIDI message to the current Part, internal sequencer and external MIDI devices. This lets you use the Sound Palette as a mixer.

<Procedure>

- 1 Call up the Part Information display of the MIDI message to be transmitted.
- 2 Press [◀] or [▶] to move the cursor to the Part whose value you want to modify.

You can adjust the values of the boxed four Parts using the sliders.

If you've selected any of Parts 1-4, sliders 1, 2, 3, and 4 adjust Parts 1, 2, 3, and 4, respectively.

If you've selected any of Parts 5-8, sliders 1, 2, 3, and 4 adjust Parts 5, 6, 7, and 8, respectively.

If you've selected any of Parts 9-12, sliders 1, 2, 3, and 4 adjust Parts 9, 10, 11, and 12, respectively.

If you've selected any of Parts 13-16, sliders 1, 2, 3, and 4 adjust Parts 13, 14, 15, and 16, respectively.

- 3 Move each slider to adjust the respective value.

.....

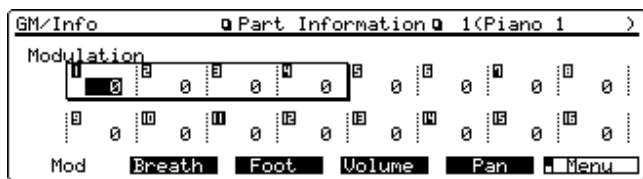

The Part Information display consists of two menus. After selecting a menu by pressing [F6] (Menu), press [F1]-[F5] to call up the display page for each MIDI message.

Modulation : [F1] (Mod)

Breath : [F2] (Breath)

Foot : [F3] (Foot)

Volume : [F4] (Volume)

Pan : [F5] (Pan)

Expression : [F1] (Exp)

Hold-1 : [F2] (Hold)

Pitch Bend : [F3] (Bend)

Channel Aftertouch : [F4] (Aft)

Convenient functions in GM mode (GM Utility)

In the GM mode, you can copy effects settings, initialize GM mode, and transmit GM mode settings, using the Utility functions.

(Basic Procedure)

- 1 Confirm GM mode, then press [UTILITY].

The GM Utility Menu display (UTILITY) will be called up.



* On GM Utility Menu as well, Menu 2 and Menu 3 functions can also be performed similarly as in other modes.

- 2 Press [F6] (Menu) to call up the menu containing the function you want.

Each time [F6] (Menu) is pressed, the display will cycle through Menu 1, Menu 2 and Menu 3 then back to Menu 1 and so on.

- 3 Select the button that corresponds to the function you want from [F1]-[F5].

The display for the desired function will appear.

* The desired function can also be selected on the GM Utility Menu display (UTILITY) by pressing [INC]/[DEC] or cursor buttons, or turning the VALUE dial to move the cursor and pressing [ENTER]. You can also direct input the number assigned to each GM Utility function using numeric keys on the GM Utility Menu (UTILITY) and press [ENTER].

- 4 Set parameters on each GM Utility display as necessary.

* To cancel the operation, press [EXIT].

- 5 Press [F6] to execute the operation.

After the operation is completed, "COMPLETE" will appear momentarily.

- 6 To return to the GM Utility Menu display (UTILITY), press [EXIT]. To return to the Play display (GM), press [UTILITY].

Copying effects settings – 2 Copy (GM Copy)

This function copies effects settings from a Patch or Performance to the GM mode.

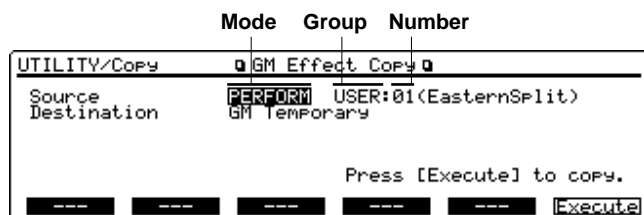

Source

Selects the Performance or Patch you want to copy the effects settings from. The Performance name or Patch name will appear in parentheses ().

Destination

GM Temporary means the effects settings will be copied to GM mode.

<Procedure>

- 1 Make sure that the GM Utility Menu display (UTILITY) is up.

- 2 Press [F6] (Menu) to select Menu 1 and then press [F2] (Copy) to call up the GM Effect Copy display (UTILITY/Copy).

This display can also be called up by moving the cursor to "2 Copy" and pressing [ENTER], or pressing the numeric key [2] and pressing [ENTER].

- 3 Move the cursor to the mode and select PERFORM or PATCH.

- 4 Press [▶] to move the cursor to the right and change the group and number to select the Performance or Patch of the source.

- 5 Press [F6] (Execute) to execute the operation.

Initializing GM mode – 3 Initialize (GM Initialize)



* As GM Initialize initializes only GM mode data, data stored in user memory will not be initialized. To initialize all settings to factory settings, use Factory Preset (UTILITY/Factory/Factory Preset).

There are two initialize methods.

GM-ON: Initializes GM mode settings using a GM System On message.

DEFAULT: Initializes all GM mode settings including effects settings to factory settings.

<Procedure>

- 1 Make sure that the GM Utility Menu display (UTILITY) is up.

- 2 Press [F6] (Menu) to select Menu 1 and then press [F3] (Init) to call up the GM Initialize display (UTILITY/Init).

This display can also be called up by moving the cursor to "3 Initialize" and pressing [ENTER] on the GM Utility Menu display (UTILITY), or pressing the numeric key [3] and pressing [ENTER].

- 3 Select one of the two initialize methods.

- 4 Press [F6] (Execute) to execute the operation.

After GM Initialize is completed, the display will return to the Play display (GM).

Transmitting GM mode settings – 4 Data Transfer (GM Data Transfer)

GM mode settings cannot be stored in user memory. In order to keep your GM mode settings, you can transmit them as a MIDI message to an external MIDI device or to the internal song.

Transmitting to an external MIDI device

GM mode settings can be transmitted to an external MIDI device via 'bulk dump.' This is used to keep GM mode settings into external MIDI device.



Source

“GM Ctrl” means that each Part’s settings will be transmitted.

GM Patch program number

Volume (controller number 7)

Panpot (controller number 10)

Reverb send level (controller number 91)

Chorus send level controller number 93)

Pitch bend sensitivity

Fine tune

Coarse tune

- * If you don’t want settings of a specific Part to be transmitted, set the Rx Switch parameter (Local/Tx/Rx window) OFF.

Destination

The setting “to MIDI” means that data will be transmitted to an external MIDI device.

<Procedure>

- 1 Make sure that the GM Utility Menu display (UTILITY) is up.
- 2 Press [F6] (Menu) to select Menu 1 and press [F4] (Xfer) to select GM Data Transfer.

You can also choose this by moving the cursor to “4 Data Transfer” and pressing [ENTER], or pressing the numeric key [4] and pressing [ENTER] on the GM Utility Menu display (UTILITY).

- 3 Press [F1] (to MIDI) to call up the Data Transfer to MIDI display (UTILITY/Xfer).
- 4 Press [F6] (Execute) to execute the operation.

“Transmitting...” will be displayed while data is being sent.

Transmitting data to the internal song

GM mode settings can be transmitted to the internal song. Data can be transmitted to a specified Song position in the Phrase track or Pattern of the internal song. Once GM mode settings are recorded at the start of a song, you can always play back the song with the GM mode settings you want.



- * To record GM mode settings as the song’s initial settings, create a 1-measure blank at the beginning of the song, and record the data in this measure. If you record the data without creating a blank measure, the timing of data playback may be affected.

Source

“GM Ctrl” means that each Part’s settings will be transmitted.

GM Patch program number

Volume (controller number 7)

Panpot (controller number 10)

Reverb send level (controller number 91)

Chorus send level (controller number 93)

Pitch bend sensitivity

Fine tune

Coarse tune

- * If you don’t want settings of a specific Part to be transmitted, set the Rx Switch parameter (Local/Tx/Rx window) OFF.

Destination

The setting “to Song” means that data will be transmitted to the internal song.

You can also specify the transmit destination (Phrase track or Pattern) and transmit Song position (measure-beat-clock). But not a Phrase track or Pattern which does not contain any sequencer data.

<Procedure>

- 1 Make sure that the GM Utility Menu display (UTILITY) is up.
- 2 Press [F6] (Menu) to select Menu 1 and press [F4] (Xfer) to select GM Data Transfer.

GM Data Transfer can also be chosen by moving the cursor to “4 Data Transfer” and pressing [ENTER] on the GM Utility Menu display (UTILITY), or by pressing the numeric key [4] and pressing [ENTER].

- 3 Press [F2] (to Song) to get the setting that transmits data to the internal song.

The Transfer to Song display (UTILITY/Xfer) will appear.

- 4 Move the cursor to TRK (track) and select the Phrase track or Pattern to which data will be sent.

You can also select a Phrase track by pressing TRACK/PART [1]-[16].

It is also possible to select a Pattern by pressing [PATTERN] and specifying the Pattern number.

- 5 Press [▶] to move the cursor to the right and specify the transmit Song position (measure-beat-clock).
- 6 Press [F6] (Execute) to execute the operation.

“Transmitting...” will be displayed while data is being transmitted.

Chapter 11. Getting the full potential of the XP-80

This section discusses various techniques for effectively using the XP-80 for specific applications. The more you use the XP-80, the faster you'll appreciate the real power of this unit.

Techniques for using Patches

Reinforcing filter characteristics

If you want to reinforce filter characteristics, set the Structure Type 1&2 parameter (PATCH/Common/Structure) to 2, and series-connect the TVFs of Tones 1 and 2.

This example shows how to boost the effectiveness of the filter for "PR-C:014 MKS-80 Brass."

<Procedure>

- 1 Select PR-C:014 MKS-80 Brass on the Play display (PATCH).
 - 2 Press [FILTER/ENV] to light the indicator.
 - 3 Move the CUTOFF and RESO. sliders while you play notes and hear how sound changes.
 - 4 Set the structure Type 1 & 2 parameter (PATCH/Common/Structure) to 2.
 - 5 Again, move the CUTOFF and RESO. sliders and hear how the sound changes. Notice the effectiveness of the filter has changed.
- * It might be easier to better hear note variations by turning [EFX], [CHORUS] and [REVERB] off.

Making the up-beat note sound at the same time you play a down-beat note

<Procedure>

- 1 Select PR-A:087 Music Bells on the Play display (PATCH) and listen to the sound.
 - 2 Call up the Wave Param display (PATCH/WG).
 - 3 Press TONE SELECT [1] to select Tone 1.
 - 4 Set Tone 1's Mode parameter to PLAYMATE and the Time parameter to 32.
 - 5 Play the XP-80's keyboard keeping a constant tempo. Tones 1 and 2 sound alternately. Tone 1 will sound at the timing point exactly between a note you press and the following note. Try various settings, for instance use different wave or modify the pitch.
- * Tone 1 will not sound if the two keys are pressed at an interval of 2 seconds or longer.

Holding a note with modulation retained

In general, pressing the Hold pedal makes a note continue to sound. However, other effects will go off. To keep other effects effective as well, perform the following procedure.

<Procedure>

- 1 Connect an optional pedal switch to the HOLD jack.
- 2 Select a Patch (PR-C:110 Crash Pad, etc.) to which an effect will be applied when the modulation lever is moved on the Play display (PATCH).
- 3 Set the Hold parameter (SYSTEM/Control/Control Source) to HOLD-1.
- 4 Call up the Common Control display (PATCH/Common) and set Ctrl 1's Peak&Hold to HOLD.
- 5 Press a note and press the pedal switch as you move

the modulation lever forward.

- 6 When the note and modulation lever are released, both the note and the effect produced by the modulation lever will be held.

Syncing the LFO cycle to sequencer tempo

<Procedure>

- 1 Select PR-B:052 Blade Racer on the Play display (PATCH).
- 2 Set the Clock Source parameter (PATCH/Common/Common General) to SEQUENCER.
- 3 Make sure that each Tone's EXT Sync parameter (PATCH/LFO&Ctl/LFO1,2 Param) is set to CLK. If not, reset.
- 4 Press [SEQUENCER] to call up the Play display (SEQ(Song)). Move the cursor to ↓ and try various values as you press a note.

The Patch's modulation tempo will also change in accordance to the sequencer's tempo clock.

- 5 Set the modulation depth as desired using <Depth> (PATCH/LFO&Ctl/LFO1,2 Param) of each Tone.
- * When you have selected PR-B:47, 49, 51, 52-56, 69, PR-C:34, 93, 97, 99, or 123, it is also possible to synchronize the LFO to the sequencer's tempo clock by setting the Clock Source parameter (PATCH/Common/Common General) to SEQUENCER. Try it.

Modifying EFX to match the tempo of a song

<Procedure>

- 1 Select PR-C:94 Albion on the Play display (PATCH).
- 2 Set the Clock Source parameter (PATCH/Common/Common General) to SEQUENCER.
- 3 Make sure that the EFX Type parameter (PATCH/Effects/General) is set to STEP-FLANGER. If not, reset.
- 4 Make sure that the Step Rate parameter (PATCH/Effects/EFX Param) is set as a note value. If not, reset using a note value.
- 5 Press [SEQUENCER] to call up the Play display (SEQ(Song)).
- 6 Move the cursor to ↓ and try various values while you play the XP-80's keyboard. You'll notice that the tempo of the Patch's modulation changes in accordance to the tempo clock of the XP-80's sequencer.

You can modify EFX parameter values in accordance to the sequencer's tempo clock, when you have selected the following types for the EFX Type parameter.

EFX Type	EFX Parameter
16: STEP-FLANGER	Step Rate parameter
19: TRIPLE-TAP-DELAY	Delay Left-Right parameter
20: QUADRUPLE-TAP-DELAY	Delay 1-4 parameter

- * When you have selected PR-B:57, 65, 68, PR-C:94, 96, and 98, it is also possible to sync the EFX parameter variations of the sequencer's tempo clock by setting the Clock Source parameter (PATCH/Common/Common General) to SEQUENCER. Try it and see.

Using a pedal switch to modify the rotary speed of the Rotary effect

<Procedure>

- 1 Call up the Pedal Assign display (SYSTEM/Control) and set any one of the Pedal 1–4's <Assign> (use Pedal 1's for this example) to CC04:FOOT-TYPE.
- 2 Select PR-A:54 Rocker Spin on the Play display (PATCH).

This Patch uses ROTARY as the EFX type.

- 3 Call up the EFX Control display (PATCH/Effects), then set the EFX Ctrl 1's Control Source to FOOT and Depth to +63.
- 4 Connect an optional pedal switch to the CONTROL PEDAL 1 jack.
- 5 When you wish to speed up the rotary effect, press the pedal switch. Releasing the pedal switch will slow down the rotary effect.

Playing phrase loops at a song's tempo

The optional Wave Expansion Board "SR-JV80-10 BASS & DRUMS" contains Patches derived from waveforms with tempo (BPM) indication (phrase loops). You can play these phrase loops in sync with the sequencer's tempo.

- * The XP-80's memory does not contain phrase loops.

<Procedure>

- 1 Select 115 AmbGrv/Bs 90 on the Play display (PATCH).
- 2 Set the Clock Source parameter (PATCH/Common/Common General) to SEQUENCER.
- 3 Call up the Wave Param display (PATCH/WG).
- 4 Change the Tone by pressing TONE SELECT [1]–[4] and look for the Tone that uses waveforms with BPM indication.

The wave name will appear in parentheses () below the Wave Number parameter. You'll notice that for this example, Patch Tone 2 uses a phrase loop called BW Swamp 90.

- 5 Set the Tone 2's Tone Delay Mode parameter to TEMPO-SYNC.
- 6 Press [SEQUENCER] to call up the Play display (SEQ(Song)).
- 7 Move the cursor to \downarrow and try various values while you press a note.

The phrase loop speed will change in accordance to the sequencer's tempo clock.

- * The phrase loop will sound with the sequencer's tempo regardless of which key you press. The settings for pitch and FXM will be ignored.

Using the C1 slider to pan sounds in real time

You can assign various functions to the C1 slider. In this example, the stereo location (pan position) of a Patch will change by moving the C1 sliders up or down.

<Procedure>

- 1 Call up the Control Assign display (SYSTEM/Control).
 - 2 Set the C1 Slider's <Assign> to CC10: PANPOT.
- * With other <Assign> settings, you can try different variations.

- 3 Select a Patch on the Play display (PATCH).
 - 4 Move the C1 slider while you play the keyboard.
- You'll notice that sound will pan right and left.

- * To better hear panning changes, turn [EFX], [CHORUS] and [REVERB] off.

Using the XP-80 to play live

Changing multiple sounds of an external MIDI device simultaneously

When a different Performance is selected, the sound corresponding to the Bank Select number and Program number of the selected Performance will usually be chosen on the external MIDI device.

Once you have set the Bank Select number and Program number for each Part to match the desired sound of the external MIDI device, you can select several sounds on the external MIDI device by changing the Performance.

- * Use a Layer Performance when performing this operation. A Single Performance will have no effect. Be sure to set the Key Mode parameter (PERFORM/Common/Common) to LAYER.

<Procedure>

- 1 Select the Part to be used to control the external MIDI device.
 - 2 Call up the Bank Select Group display (SYSTEM/MIDI).
 - 3 Set the external MIDI device's Bank Select (Bank MSB and Bank LSB) to any of Grp1–7. Set Grp1–7's Switch parameter ON so that Bank Select can be sent to the external MIDI device.
 - 4 Call up the Part MIDI display (PERFORM/MIDI) of the selected Part. Then set the Channel parameter to the external MIDI device's receive channel, the Tx Switch parameter ON and the Tx Bank Select parameter to the same Grp1–7 as you did in step 3 above.
 - 5 Call up the Part Param display (PERFORM/Part) and set the Patch Number parameter to the same number as the Program number of the sound you wish to play from the external MIDI device.
- * If the Program number of the external MIDI device reads 0–127, set the P.C Number parameter by adding 1 to the external MIDI device's value.
 - 6 Save the Performance.
 - 7 Try changing from another Performance to the Performance just saved, and see if the sound of the external MIDI device changes to what you want. If not, check your settings and the external MIDI device.

Changing sounds with a pedal switch

You can change Patch/Performance/Rhythm set in succession using a pedal switch.

<Procedure>

- 1 Connect a pedal switch to a CONTROL PEDAL jack (1 for this example).
 - 2 Call up the Pedal Assign display (SYSTEM/Control) and set Pedal 1's <Assign> to 98:PROG-UP.
 - 3 Call up the Play display of a sound source.
 - 4 Each time you press the pedal, you call up the next Patch, Performance or Rhythm Set.
- * If you connect another pedal switch to CONTROL PEDAL jack 2 and set Pedal 2's <Assign> to 99:PROG-DOWN, you can go back and forth as desired between Patches/Performances/Rhythm Sets by using the two pedal switches.

Using a pedal switch to start and stop playback

<Procedure>

- 1 Connect an optional pedal switch to any of CONTROL PEDAL jack 1-4 (1 for this example).
- 2 Call up the Pedal Assign display (SYSTEM/Control) and set Pedal 1's <Assign> to 100:START/STOP.
- 3 Select the song you wish to play back on the Play display (SEQ(Song)).
- 4 Press the pedal switch to start playback. To stop, press the pedal switch again.

Matching the song's playback tempo with the tempo of the band that's playing

You can control the song's playback tempo of a song in real time by pressing the pedal at specific intervals.

<Procedure>

- 1 Connect an optional pedal switch to any of CONTROL PEDAL jacks 1-4 (1 for this example).
- 2 Call up the Pedal Assign display (SYSTEM/Control) and set Pedal 1's <Assign> to 102:TAP-TEMPO.
- 3 As soon as you start playback of a song, have the band start to play.
- 4 If the song's playback tempo starts to go off from the band performance, press the pedal switch at a quarter-note timing to adjust to the band performance.

The song's playback tempo will change in accordance to the time interval you press the pedal switch.

Playing a drum referring to a XP-80 click

<Procedure>

- 1 Connect the drummer's set of headphones to the CLICK OUT OUTPUT jack.

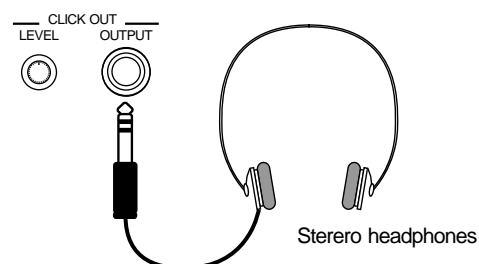

- 2 When the song is played back, a click will be heard.
- 3 Adjust CLICK OUT LEVEL control to get the desired click volume level.

Adjust the volume balance between the amplifier for monitoring other instruments and the click.

Song making techniques

Recording a song with a consistent volume level regardless of keyboard playing dynamics

<Procedure>

- 1 Set the Keyboard Velocity parameter (SYSTEM/Setup) to the setting you like.

For instance, set a value of 20 or less for pianissimo, approximately 64 for mezzo forte and 100 or greater for fortissimo.

- 2 Play the keyboard.

Regardless of keyboard playing dynamics, the song will be recorded at a consistent volume (velocity).

Having a song fade in or out

To have a song fade in or out, mix-record volume changes after you've recorded a song.

<Procedure>

- 1 Record a song.
- 2 Press [REC] to call up the Realtime Rec Stand-by display (SEQ), then set the Mode parameter to MIX and other parameters as desired.
- 3 Move the cursor to "PART," and press TRACK/PART [1]-[16] to select the Part whose volume level you want to modify.

If you've selected any of Parts 1-4, SOUND PALETTE sliders 1, 2, 3, and 4 adjust Parts 1, 2, 3, and 4, respectively.

If you've selected any of Parts 5-8, SOUND PALETTE sliders 1, 2, 3, and 4 adjust Parts 5, 6, 7, and 8, respectively.

If you've selected any of Parts 9-12, SOUND PALETTE sliders 1, 2, 3, and 4 adjust Parts 9, 10, 11, and 12, respectively.

If you've selected any of Parts 13-16, SOUND PALETTE sliders 1, 2, 3, and 4 adjust Parts 13, 14, 15, and 16, respectively.

- * The recording destination will be the Phrase track of the same number with the selected Part. When recording volume data on another Phrase track, move the cursor to "TRACK" and either turn the VALUE dial or press [INC]/[DEC].
- ④ To fade a song in, set the slider to its lowest setting. To fade a song out, set the slider to its highest setting. Otherwise, raise the slider to an appropriate position.
- ⑤ Press [LEVEL] to light the indicator.
- ⑥ Start recording in the method you've specified for "Count In."
- ⑦ Move the slider to adjust the volume level.
- ⑧ After completing volume adjustment, press [STOP/PLAY] to end recording.
- * It is possible to simultaneously control volume for up to four Parts. If you are using more Parts, copy the volume change data (Volume) using the Track Edit function, then change the MIDI channel to match the Part setting.
- * If the song drags, use Data Thin in track editing to thin out Expression data as necessary.

Changing a sound during a song

To change an instrument sound during a song, record the Bank Select (MSB and LSB) and Program numbers at the Song position where you want to change the sound. Recording such data will make sure the song always plays back with the selected sound.

- * If just the Program number is received, without the Bank Select number, the sound within a specific group such as PR-A and USER will change.
- * If you select another Patch/Performance/Rhythm Set when recording a song, the Bank Select number and Program number of the selected Patch/Performance/Rhythm Set will automatically be recorded.
If you select another Patch/Performance/Rhythm Set on the Realtime Rec Stand-by display (SEQ), the Bank Select number and Program number of the Patch/Performance/Rhythm Set will be recorded at the recording start point.

Changing the Patch

Group	Patch Number	Bank Select		Program number
		MSB	LSB	
USER	1-128	80	0	1-128
PR-A	1-128	81	0	1-128
PR-B	1-128	81	1	1-128
PR-C	1-128	81	2	1-128
GM	1-128	81	3	1-128
XP-A	1-128	84	0	1-128
XP-A	129-256	84	1	1-128
XP-B	1-128	84	2	1-128
XP-B	129-256	84	3	1-128
XP-C	1-128	84	4	1-128
XP-C	129-256	84	5	1-128
XP-D	1-128	84	6	1-128
XP-D	129-256	84	7	1-128

Changing the Performance

Group	Performance Number	Bank Select		Program number
		MSB	LSB	
USER	1-32	80	0	1-32
PR-A	1-32	81	0	1-32
PR-B	1-32	81	1	1-32

- * When selecting another Performance, the MIDI channel of the Bank Select number and Program number to be recorded must match the Performance Ctrl-Ch parameter (SYSTEM/MIDI/MIDI Param 1) setting. To change the Patch or Rhythm Set assigned to a Part, match the MIDI channel (of the Bank Select number and Program number to be recorded) with the Part's MIDI channel. However, if the Performance Ctrl-Ch parameter setting and the Part's MIDI channel correspond to each other, the Performance Ctrl-Ch parameter setting will take priority, selecting a new Performance.

Changing the Rhythm Set

Group	Rhythm set Number	Bank Select		Program number
		MSB	LSB	
USER	1, 2	80	0	1, 2
PR-A	1, 2	81	0	1, 2
PR-B	1, 2	81	1	1, 2
PR-C	1, 2	81	2	1, 2
GM	1, 2	81	3	1, 2
XP-A	1-128	84	0	1-128
XP-A	129-256	84	1	1-128
XP-B	1-128	84	2	1-128
XP-B	129-256	84	3	1-128
XP-C	1-128	84	4	1-128
XP-C	129-256	84	5	1-128
XP-D	1-128	84	6	1-128
XP-D	129-256	84	7	1-128

- * When selecting another Rhythm Set, match the MIDI channel of the Bank Select number and Program number to be recorded to that of Part 10 of a Performance. With the default setting, the MIDI channel of Part 10 is set to 10.

<Procedure>

- ① Call up the Microscope display (SEQ/Micro).
 - ② Press [▲] or [▼] to move ">" to the Song position at which you want an instrument sound to change.
- If that Song position is not on the display, move the cursor to an appropriate Song position (measure-beat-clock) and specify the location using the numeric keys.
- ③ Press [F1] (Create) to call up the Create Event display (SEQ/Micro).
 - ④ Move the cursor to "Control Change".
 - ⑤ Press [F6] (Execute).
 - ⑥ Set CC# (Controller number) to 0, then specify Bank Select MSB.
 - ⑦ Repeat steps 3-5.
 - ⑧ Set CC# (Controller number) to 32, then specify Bank Select LSB.
 - ⑨ Press [F1] (Create) to call up the Create Event display (SEQ/Micro).
 - ⑩ Move the cursor to "Program Change".
 - ⑪ Press [F6] (Execute).
 - ⑫ Input the desired Program number.

Avoiding sound dropouts in a song

The XP-80 can produce up to 64 voices simultaneously. But if you request more than 64 simultaneous voices, notes exceeding the limit will be turned off in order of priority starting from the lowest priority note, to be able to accommodate the newly requested notes. You can prevent this by using Voice Reserve to ensure a minimum number of notes will always be available for each Part.

<Simultaneous voices>

The XP-80 can produce up to 64 simultaneous voices. The number 64 however does not represent simply the number of notes being played, but is affected by the number of Tones used in each Patch. If you are playing one Patch which uses just one Tone with a single key press, you can produce just one note at one time. If you play two Patches, each using four Tones, by pressing two notes, you're using eight simultaneous voices. Calculating the number of simultaneous voices is easy using this formula: (number of currently sounding notes) x (number of Tones used in the Patch being played).

If you are using the XP-80 in Performance mode to play an ensemble, count the total number of Tones used by all the Parts.

<Procedure>

- 1 Select the Performance you want on the Play display (PERFORM).
- 2 Press [◀] or [▶] to select the Part for which you want to reserve notes.
- 3 Press [▼] to call up the Play display of a Patch assigned to the Part.
- 4 Confirm the Tones used by the Patch shown below the Patch name.

For example, a "Tone:12--" indication means two out of four Tones are used.

- 5 Press [▲] to return to the Play display (PERFORM).
- 6 Call up the Part Param display (PERFORM/Part).
- 7 Set the Voice Reserve parameter to the number of notes to be reserved.

Using external MIDI devices

Using the XP-80 to change the sound on an external MIDI device

<Procedure>

- 1 Press [LOCAL/TX/RX] to open the LOCAL/TX/RX window.
- 2 Press [F2] (Tx P.C) or [F3] (Tx P.C) to call up the Transmit Program Change window.



- 3 Set the Channel (MIDI channel), P.C Number (Program number), Bank Select MSB, and Bank Select LSB parameters to match the sound used by the external MIDI device.
- * If the Program number of the external MIDI device reads 0–127, set the P.C Number parameter by adding 1 to the external MIDI device's value.
- 4 Press [F6] (Trans) to change the sound of the external MIDI device.

Using the XP-80 to control external MIDI devices

<Procedure>

- 1 Connect the XP-80's MIDI OUT to the MIDI IN of the external MIDI device using a MIDI cable.
- 2 Set the XP-80's MIDI channel to match the external MIDI device's receive channel.

The MIDI channel is determined by the following parameters.

Patch mode: Patch Tx-Ch parameter (SYSTEM/MIDI/MIDI Param 1)

Performance mode: Channel parameter (PERFORM/MIDI/Part MIDI), Tx Switch parameter (PERFORM/MIDI/Part MIDI) ON

- 3 If you want to play just the sound source of the external MIDI device, set the Local Switch parameter (SYSTEM/MIDI/MIDI Param 1) OFF.

When you want to connect two or more external MIDI devices, use the MIDI THRU connector of the external MIDI devices.

- * If you daisy-chain three or more MIDI devices using IN→THRU→IN→THRU..., the MIDI signal may become garbled and cause errors in data. Using a MIDI Thru Box is recommended in such cases. MIDI Thru Boxes allow a single stream of MIDI data to be sent to a large number of MIDI devices or sound modules without causing data errors.

Playing the XP-80 sound source from an external MIDI device

<Procedure>

- 1 Connect the XP-80 MIDI IN to MIDI OUT of the external MIDI device using a MIDI cable.
- 2 Set the XP-80's MIDI channel to match the external MIDI device's transmit channel.

The MIDI channel is determined by the following parameters.

Patch mode: Patch Rx-Ch parameter (SYSTEM/MIDI/MIDI Param 1)

Performance mode: Channel parameter (PERFORM/MIDI/Part MIDI), Rx Switch parameter (PERFORM/MIDI/Part MIDI) ON

Synchronization with external MIDI devices

Syncing an external sequencer to the XP-80's sequencer

<Procedure>

- 1 Connect the XP-80 MIDI OUT to the MIDI IN of the external MIDI sequencer using a MIDI cable.
- 2 Press [SEQUENCER] to call up the Play display (SEQ(Song)).
- 3 Set the Sync Mode parameter (SEQ/Setup/SEQ System Setup) to INTERNAL and the Sync Out parameter (SEQ/Setup/SEQ System Setup) ON.
- 4 Set the external sequencer to sync to the XP-80's sequencer.
- 5 Press [STOP/PLAY], and the XP-80's sequencer and the external sequencer will begin playback simultaneously.

When the playback ends on the XP-80's sequencer, the external sequencer will also stop playback. To interrupt playback, press [STOP/PLAY].

Syncing the XP-80's sequencer to an external sequencer

<Procedure>

- 1 Connect the XP-80 MIDI IN to the MIDI OUT of the external MIDI sequencer using a MIDI cable.
- 2 Press [SEQUENCER] to call up the Play display (SEQ(Song)).
- 3 Set the Sync Mode parameter (SEQ/Setup/SEQ System Setup) to SLAVE.
- 4 Set the external sequencer so that it will transmit MIDI clock messages.
- 5 When you start playback on the external sequencer, the XP-80's sequencer will begin playback.

When the playback ends on the external sequencer, the XP-80's sequencer will also stop playback. To interrupt playback, stop playback on the external sequencer.

- * If you just want to control song playback start/stop from an external sequencer and do not need the XP-80 to sync to the incoming MIDI clock, set the Sync Mode parameter to REMOTE.

- * When Song Select message 0 is received from an external sequencer, the song in internal memory (song number 0) will be selected. When Song Select message 1 is received, the first song saved on disk (song number 1) will be selected.

- * When a Song Position Pointer message is received from an external sequencer, the current Song position of the song in internal memory will change accordingly.

Recording a song from an external sequencer into the XP-80's sequencer

<Procedure>

- 1 Connect the XP-80 MIDI IN to the MIDI OUT of the external MIDI sequencer using a MIDI cable.
- 2 Press [SEQUENCER] to call up the Play display (SEQ(Song)).
- 3 Set the Sync Mode parameter (SEQ/Setup/SEQ System Setup) to SLAVE.
- 4 Set the external sequencer so that it will transmit MIDI clock messages.
- 5 Press [REC] to get ready for recording.
- 6 To start recording, play back the song on the external sequencer.
- 7 To stop recording, stop playback on the external sequencer.

Synchronizing to the VS-880 Hard Disk Recorder

You can connect the XP-80 to the VS-880 and synchronize it to the VS-880 so you can easily put together the song you have created on the XP-80 with vocals or acoustic instrument performance. In other words, by syncing to the VS-880, you can create an audio track for the XP-80. Both the XP-80 and VS-880 can serve as a controller, so you can easily synchronize with vocals or your own acoustic instrument as you play.

<Connecting the XP-80 to the VS-880>

When synchronizing the XP-80 to the VS-880, the following relationship will be established.

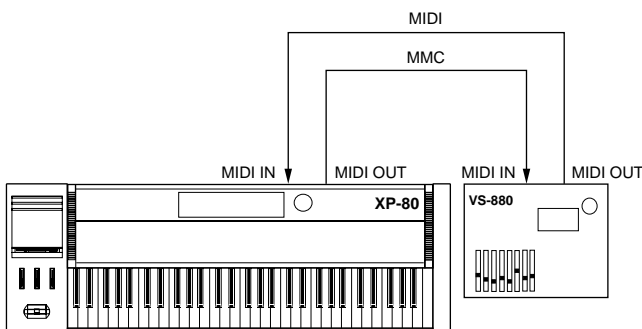

The XP-80 can control start and stop of song playback and move to a different Song position in the song by transmitting MMC commands to the VS-880. The VS-880 in turn controls start and stop of the song playback and recording as well as moving to a different Song position in the song by sending MIDI messages to the XP-80. This makes it possible to perform loop play or punch-in recording that records only at a specified point.

<MMC (MIDI Machine Control)>

MMC is a protocol used to control tape recorders, video tape recorders, digital recording systems and other recorders by MIDI. Thirty seven MMC commands are available including Stop and Play.

Getting ready to sync to the VS-880

Setting parameters

To have the XP-80 sync to the VS-880, set the XP-80's parameters as shown below. These parameters should be reset to the original settings after synchronization is completed.

MMC Output parameter (SEQ/Setup/SEQ System Setup)

When using the XP-80 to control the VS-880, put ON. When using the XP-80 to be controlled by the VS-880, put OFF.

- * Actions cannot be carried out correctly when the VS-880 controls the XP-80 with MMC Output parameter ON.

Frame Mode parameter (SEQ/Setup/SEQ System Setup)

To match the XP-80's frame rate with the VS-880's, set this parameter to the same value as the VS-880's MTC Type parameter setting. If the VS-880's MTC Type parameter is set to 29N, set this parameter to 30.

- * When connecting the XP-80 to the VS-880, it is recommended to set both units' parameters to 30.

Offset Time parameter (SEQ/Setup/SEQ System Setup)

To allow the XP-80 and VS-880 to locate the same Song position, set this parameter to the same value as the VS-880's Ofs parameter setting.

Recording the XP-80 song's MIDI clock on the VS-880's sync track

To synchronize the XP-80 to the VS-880, you can either use the VS-880's sync track or tempo map.

When synchronizing a song with a constant tempo from song beginning to end or with just a minor tempo change, you should create a tempo map before syncing. For details, refer to the VS-880's instructions. In this case, below mentioned procedures are not necessary.

When syncing a song containing gradual tempo changes such as accelerandos or ritardandos, use a sync track. When compared to the tempo map that sets tempo in measure intervals, using the sync track makes it possible to follow subtle tempo changes more accurately.

- * Insert several blank measures at the beginning of the VS-880 and XP-80 songs in order to avoid any sync instability.

<Procedure>

- 1 Connect the XP-80 to the VS-880 via a MIDI cable as shown below.

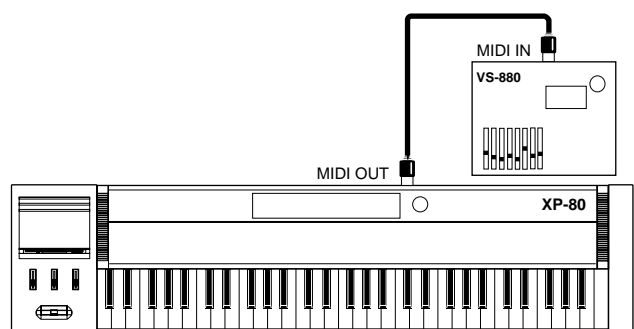

- 2 Make sure that the Sync Mode parameter (SEQ/Setup/SEQ System Setup) is set to INTERNAL, Sync Output parameter (SEQ/Setup/SEQ System Setup) is set to ON, MMC Output parameter (SEQ/Setup/SEQ System Setup) is set to ON.
- 3 Select the XP-80 song that you want to sync to the VS-880.
- 4 Set the VS-880 parameters so that it can record a MIDI clock on its sync track.
- * For details, refer to the VS-880's instructions.
- 5 Press [STOP/PLAY] to play back the XP-80 song.

As soon as the XP-80 song playback begins, the MIDI clock will be recorded on the VS-880's sync track. Once song playback ends, the VS-880 will stop the MIDI clock recording automatically.

Checking the time for a Song position

Because XP-80 and VS-880 manage measures in different ways, measure indications may not match each other. You can avoid this when syncing the XP-80 to the VS-880 by using time-based management.

On the XP-80, a song position is normally indicated with “measure-beat-clock.” However, the Locate window also shows a song position with “hour:minute:second:frame.” Check the time indication for the specified song position using the following procedure.

<Procedure>

- ❶ Access the Play display (SEQ(Song)) or the Microscope display (SEQ/Micro), and move to the song position which time you want to check.
- ❷ Press [LOCATE] to open the Locate window.

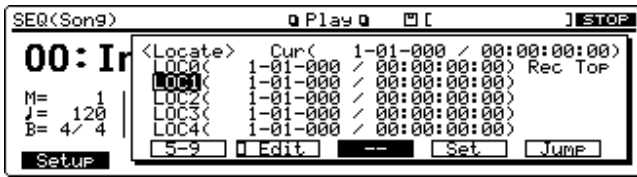

- ❸ The top line of the Locate window shows the time corresponding to the current position, so check the time.
- * If you have set the Offset Time parameter (SEQ/Setup/SEQ System Setup), that setting will be added to the time.
- ❹ A Locate position can be specified in terms of time, in the same manner as you use “measure-beat-clock.”

Playing back Song files

- * Because the XP-80 and VS-880 manage measures in different ways, measure indications may not match each other if the Song contains a time signature change/Tempo change or loop play is conducted while sync-playing. However, the actual playback will be in sync.

<Procedure>

- ❶ Make sure that preparations are done correctly before playback. Refer to above heading “Getting ready to sync to the VS-880.”
- ❷ Set the Sync Mode parameter (SEQ/Setup/SEQ System Setup) to SLAVE.
- ❸ Connect the XP-80 to the VS-880 using MIDI cables as shown below.

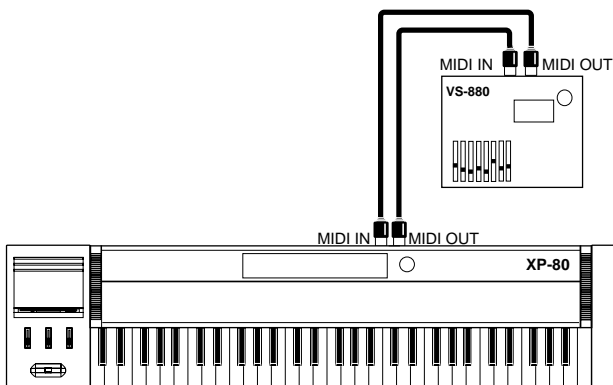

- ❹ Select the XP-80 song you want to sync to the VS-880.
- ❺ Set the VS-880’s parameters to prepare for synchronization.

SYS MIDI PRM

MIDIThr parameter : Out
 SysEx.Rx parameter : ON
 MMC parameter : SLAVE
 CtrType parameter : Off

SYS SYNC/Tempo

Source parameter : INT
 Gen. parameter : MIDIClk or SyncTr

- * For details, refer to the VS-880’s instructions.

- ❻ Start playback a Song.

Put MMC Output parameter (SEQ/Setup/SEQ System Setup) ON, when starting playback the Song with XP-80. Put MMC Output parameter OFF, when starting playback the Song with VS-880.

Recording on the VS-880

- * Because the XP-80 and VS-880 manage measures in different ways, measure indications may not match each other if the song contains a time signature change or tempo change while sync-recording. However, the actual recording will be in sync.

<Before recording on the VS-880>

In a song recorded on the XP-80, each bit of sequencer data is recorded as a MIDI message, making editing simpler. But they cannot be recorded along with acoustic instruments play or vocals. On the VS-880, acoustic instrument performance and vocals can be recorded directly.

You can record drums, bass and other instrument parts on the XP-80 for completing a song framework, then record acoustic instruments or vocals on the VS-880 that’s in sync.

- * When recording a song containing a tempo change, first record the XP-80 song’s MIDI clock on the VS-880’s sync track. Remember it is difficult to change the song’s length after the MIDI clock has been recorded on the sync track. Therefore complete the XP-80 song before recording the MIDI clock on the sync track.

<Procedure>

- ❶ Make sure that preparations are done correctly before recording on VS-880. Refer to above heading "Getting ready to sync to the VS-880."
- ❷ Set the Sync Mode parameter (SEQ/Setup/SEQ System Setup) to SLAVE.
- ❸ Connect the XP-80 to the VS-880 with MIDI cables and audio cables as shown below. Then connect a microphone for acoustic instruments or vocals to the VS-880 via an audio cable.

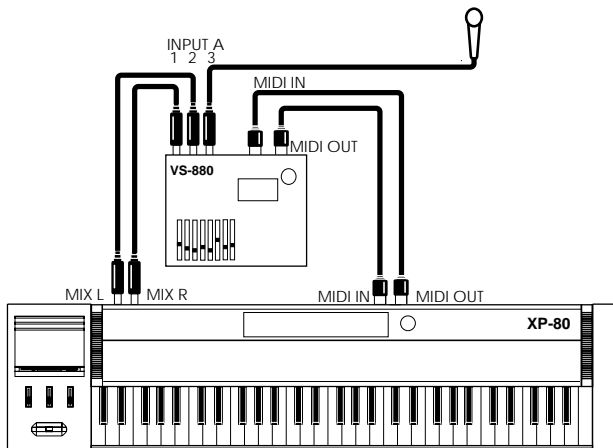

- ❹ Select the XP-80 song you want to sync.
- ❺ Set the VS-880's parameters to prepare for synchronization.

SYS MIDI PRM

MIDIThr parameter : Out
 SysEx.Rx parameter : ON
 MMC parameter : SLAVE
 CtrType parameter : Off

SYS SYNC/Tempo

Source parameter : INT
 Gen. parameter : MIDIclk or SyncTr

- * For details, refer to the VS-880's instructions.
- ❻ Start recording on the VS-880. Start a vocal or an acoustic instrument performance simultaneously with the XP-80's Song playback.

Put MMC Output parameter (SEQ/Setup/SEQ System Setup) OFF, when starting to record the Song with VS-880. Put MMC Output parameter ON, when starting to record the Song with XP-80.

<Re-recording a part of a song>

If you've made a mistake during recording or you don't like the performance you've recorded, you can re-record the part you specify with punch-in recording. But you cannot auto punch-in record on the VS-880 using the Loop function. To perform punch-in recording with the Loop function, use manual punch-in recording.

Recording on the XP-80

To re-record drums, bass or other instrument parts you've created on the XP-80 after completing the recording of acoustic instrument performance or vocals, use the following procedure:

- * When recording on the XP-80 with the VS-880 sync'd to the XP-80, it is not possible to record loops on the XP-80.
- ❶ Make sure that preparations are done correctly before recording on the XP-80. Refer to above heading "Getting ready to sync to the VS-880."
- ❷ Set the Sync Mode parameter (SEQ/Setup/SEQ System Setup) to SLAVE.
- ❸ Connect the XP-80 to the VS-880 with MIDI cables as shown below.

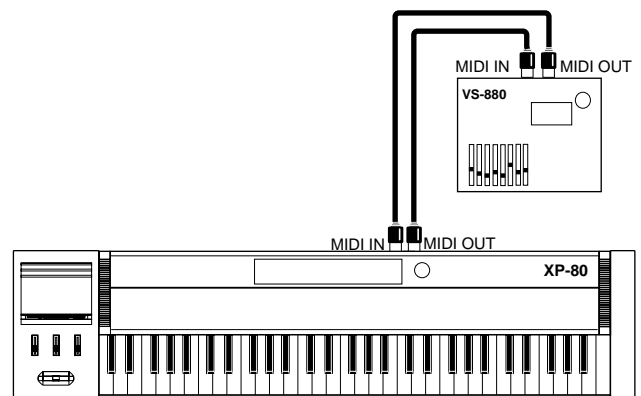

- ❹ Set the XP-80 parameters to prepare for recording.
- * To start recording, set Count In to 0 or Wait Note. If Count In is set to 1 or 2, recording will be delayed by one or two measures.
- ❺ Set the VS-880's parameters to prepare for synchronization.

SYS MIDI PRM

MIDIThr parameter: Out
 SysEx.Rx parameter: ON
 MMC parameter: SLAVE
 CtrType parameter: Off

SYS SYNC/Tempo

Source parameter: INT
 Gen. Parameter: MIDIclk or SyncTr

- * For details, refer to the VS-880's instructions.
- ❻ Start recording on the XP-80.

Put MMC Output parameter (SEQ/Setup/SEQ System Setup) ON, when starting to record the Song with XP-80. Put MMC Output parameter OFF, when starting to record the Song with VS-880.

Chapter 12 Supplementary material

Troubleshooting

If the XP-80 does not produce any sound, or if it is not functioning the way you expect, run through the following checks first. If this does not help you to solve the problem, contact your dealer or closest Roland service station.

- * Since it may be impossible to restore data contents on disk once the disk has been corrupted, Roland assumes no liability regarding data loss.

No sound when the keyboard is played

XP-80 power or the connected equipment's power has been turned off. (p. 17)

The XP-80's VOLUME slider is turned all the way down. (p. 16)

The volume of the connected amp/mixer is turned all the way down.

Audio cables may be loose or not connected correctly.

The selected XP-A–XP-D Patch or Rhythm Set does not have its relevant Wave Expansion Board correctly installed. (p. 45)

The Local Switch parameter (SYSTEM/MIDI Param 1) is set OFF.

→ **Reset the Local Switch parameter ON.** (p. 90, 91)

When a Layer Performance is selected, the Local Switch parameter (PERFORM/MIDI/Part MIDI) is set OFF.

→ **Reset the Local Switch parameter ON.** (p. 67)

A key range has been set.

→ **Check the Part Key Range Lower:Upper display (PERFORM/K.Range) or the Tone Key Range Lower:Upper display (PATCH/Common/K.Range).** (p. 50, 66)

MIDI messages such as Volume or Expression have been received during song playback, via pedal operation, or from an external MIDI device, to lower the volume.

→ **Use the Panic function to raise the volume by holding down [SHIFT] as you press [EXIT] longer than one second.** (p. 38)

→ **If you are in Performance mode, access the Part Information display (PERFORM/Info) and reset the Volume or Expression values.** (p. 69)

All Tones of the Patch are off.

→ **Press TONE SWITCH [1]–[4] to light the indicator.** (p. 27)

Pitch is incorrect

The tuning of the XP-80 is incorrect.

→ **Check the Master Tune parameter (SYSTEM/Tune).** (p. 89)

Pitch has been affected by Pitch Bend messages received during song playback, via pedal operation or from an external MIDI device.

→ **Use the Panic function to correct pitch by holding down [SHIFT] as you press [EXIT] longer than one second.** (p. 38)

→ **If you are in Performance mode, access the Part Information display (PERFORM/Info) and reset the Pitch Bend value.** (p. 69)

Effects are not activated

[EFX], [CHORUS] and/or [REVERB] is off.

→ **Press the necessary effects button to light the indicator.** (p. 40)

No sound when a song is played back

The Phrase tracks are muted.

→ **Call up the Play display (SEQ(Song)) and press TRACK/PART [1]–[16] to light the indicator.** (p. 100)

The Rx Switch parameter (PERFORM/MIDI/Part MIDI) is set OFF.

→ **Reset the Rx Switch parameter ON.** (p. 67)

The song does not play back correctly

The song is being played back from the middle.

→ **Perform MIDI Update by pressing [STOP/PLAY] while holding down [SHIFT].** (p. 99)

A GS format song is being played back.

→ **The XP-80 is compatible with the GM System, but not with the GS format, so a GS format song will not play back correctly on the XP-80.**

Cannot record a song

The Local Switch parameter (SYSTEM/MIDI Param 1) is OFF.

→ **Reset the Local Switch parameter ON.** (p. 90, 91)

When a Layer Performance is selected, the Local Switch parameter (PERFORM/MIDI/Part MIDI) is OFF.

→ **Reset the Local Switch parameter ON.** (p. 67)

Sequencer does not operate

The Sync Mode parameter (SEQ/Setup/SEQ System Setup) is set to SLAVE.

→ **Reset the Sync Mode parameter to INTERNAL.** (p. 117)

Pattern does not play back

The song that contains the Pattern you want to play back has not been loaded into internal memory.

→ **Load the song into internal memory.** (p. 101)

A Pattern Call message is recorded in a Pattern.

→ **Pattern Call messages recorded in a Pattern are ignored. To record data from another Pattern in a Pattern, use the Copy track editing function.** (p. 124)

Error messages

If there has been an operational error, or if the XP-80 is unable to continue as you commanded, a window will open to display a momentary error message. If the error message reads "Press [ENTER]," it is not possible to perform an operation until [ENTER] is pressed. Take the appropriate action for the error message displayed.

- * Since it may be impossible to restore data contents on disk once the disk has been corrupted, Roland assumes no liability regarding data loss.

Error messages are below in alphabetical order.

Battery Low

SITUATION: The internal backup battery (for preserving the contents of user memory) has run down.

ACTION: Consult your dealer or the closest Roland service station to have the battery replaced.

Cannot Read The Song/File

SITUATION: This song or file was incorrect and therefore could not be handled.

ACTION: Do not use the song or file.

Chain Step Over

SITUATION: Up to 99 songs can be stored in a chain. No more songs can be stored.

Data not Found

SITUATION: Since data was not found at the specified location, the operation could not be executed.

ACTION: Specify the correct location.

Disk Full

SITUATION: Insufficient free space available on the disk to save the data.

ACTION: Either insert a different disk (formatted on the XP-60/XP-80) or delete unnecessary data and retry the operation.

Disk not Ready

SITUATION: A disk is not inserted in the disk drive.

ACTION: Insert a disk.

Disk Read/Write Error

SITUATION: A file is corrupted, the disk is scratched or damaged, or the disk drive is malfunctioning.

ACTION: Insert another disk formatted on the XP-60/XP-80 (not containing important data). If this solves the problem, the problem is probably a scratched or damaged disk, or a corrupted file. Do not use the disk. If the same error message appears repeatedly, a malfunctioning disk drive is suspected. If the disk drive is malfunctioning, it could damage the disk. Consult your dealer or closest Roland service station.

Disk Write Protected

SITUATION: Since the write protect tab of the disk is in the Protect position, data cannot be written to the disk.

ACTION: Set the write protect tab to the Write position, and retry the operation.

File Name Duplicate

SITUATION: A file with the same name already exists on the disk.

ACTION: Use a different file name.

File Name Format Error

SITUATION: A file name has not been assigned.

ACTION: Assign a file name.

File not Found

SITUATION: The specified file was not found.

ACTION: Insert the disk that contains the specified file, and try the operation once again.

Internal Memory Full

SITUATION: Internal memory is full, and operation cannot continue.

ACTION: Use Data Reduce (UTILITY/Memory) to delete unwanted data. This may allow the operation to continue.

Master Disk

SITUATION: This disk is a master disk. Master disks cannot be used to save data or be formatted.

MIDI Buffer Full

SITUATION: Due to an inordinate volume of MIDI messages received, the XP-80 has failed to process them properly.

ACTION: Reduce the amount of MIDI messages to be transmitted.

MIDI Communication Error

SITUATION: A problem has occurred with MIDI cable connections.

ACTION: Check that MIDI cables are firmly plugged in and in good condition.

Next Song Queue Full

SITUATION: Up to three songs can be programmed for Quick Play. If three songs have already been programmed, no more can be programmed.

No Track Selected

SITUATION: No Phrase track has been selected for quantization, so the operation cannot execute.

ACTION: Specify the Phrase track(s) you want to quantize, and repeat the operation.

Now Playing

SITUATION: The operation cannot execute while a song is playing back.

ACTION: Either interrupt playback or wait until song playback is finished. Retry the operation.

Now Recording

SITUATION: The operation cannot execute while a song is being recorded.

ACTION: Either interrupt recording or wait until recording ends. Retry the operation.

Position Error

SITUATION: The specified area for track editing or quantization is inappropriate.

ACTION: Specify a correct area.

Recording Error

SITUATION 1: Attempting to record too much sequencer data at once will prevent the XP-80 sequencer from recording it all.

ACTION 1: Reduce the amount of sequencer data and retry recording.

SITUATION 2: Because the specified area for loop recording or auto punch-in recording was inappropriate, the XP-80's sequencer could not record the sequencer data.

ACTION 2: For auto punch-in recording, check to see that recording did not begin after the specified area.

Same Track or Pattern Selected

SITUATION: The same Phrase Track or Pattern is selected for the Source track and Destination track for track editing.

ACTION: Select different Phrase Tracks or Patterns for the Source track and Destination track.

System Exclusive Message:

Check Sum Error

SITUATION: The check sum of a received System Exclusive message was incorrect.

ACTION: Set the correct Check Sum value.

System Exclusive Message:

Receive Data Error

SITUATION: A MIDI message was received incorrectly.

ACTION: If the same error message is displayed repeatedly, the problem lies with the MIDI messages that are being transmitted to the XP-80.

System Exclusive Message:

User Memory Write Protected

SITUATION: Since the System Exclusive Message parameter (UTILITY/Protect/User Memory Protect) is set ON, the System Exclusive message could not be received.

ACTION: Reset the System Exclusive Message parameter OFF.

Unformatted Disk

SITUATION: This disk cannot be used by the XP-80.

ACTION: Format the disk on the XP-80.

User Memory Damaged

SITUATION: The data in user memory has been corrupted or lost.

ACTION: Use the Factory Preset function (UTILITY/Factory) to reinitialize the memory to factory default settings.

User Memory Write Protected

SITUATION: Because the Write Operation parameter (UTILITY/Protect/User Memory Protect) is ON, the writing operation could not execute.

ACTION: Reset the Write Operation parameter OFF.

Volume Name Format Error

SITUATION: It is not possible to assign a blank volume name.

ACTION: Specify a character or symbol.

You Cannot Copy This Message

SITUATION: The specified data cannot be copied.

You Cannot Delete End of Step

SITUATION: The last step of a chain (END) cannot be deleted.

You Cannot Erase This Message

SITUATION: The specified data cannot be erased.

You Cannot Move This Message

SITUATION: The specified data cannot be moved.

You Cannot Save This Song as an SMF

SITUATION: This song contains copyrighted information. Songs that contain copyrighted information cannot be saved as a Standard MIDI File.

ACTION: Save the data as an MRC Pro song.

You Cannot UNDO!!

SITUATION: The most recently executed operation cannot be undone by pressing [UNDO/REDO].

Parameter List

Patch Parameters

Common Group

Common General Display (P.46)

Parameter Name	Full Name of Parameter	Value
Patch Name	Patch name	ASCII Characters (max. 12)
Patch Level	Patch level	0—127
Patch Pan	Patch pan	L64—63R
Analog Feel	Analog feel depth	0—127
Bend Range Up	Bend range up	0—12
Bend Range Down	Bend range down	0—48
Octave Shift	Octave shift	-3—+3
Stretch Tune Depth	Stretch tune depth	OFF,1—3
Voice Priority	Voice priority	LAST,LOUDEST
Clock Source	Patch clock source	PATCH,SEQUENCER
Patch Tempo	Patch tempo	20—250

Common Control Display (P.47)

Parameter Name	Full Name of Parameter	Value
Key Assign	Key assign	POLY,SOLO
Legato Switch	Solo legato switch	OFF,ON
Switch	Portamento switch	OFF,ON
Time	Portamento time	0—127
Type	Portamento type	RATE,TIME
Mode	Portamento mode	NORMAL,LEGATO
Start	Portamento start	PITCH,NOTE
Ctrl 1 Control Source	Controller 1 control source	MODULATION
Ctrl 1 Peak&Hold	Controller 1 peak&hold	OFF,HOLD,PEAK
Ctrl 2 Control Source	Controller 2 control source	1*
Ctrl 2 Peak&Hold	Controller 2 peak&hold	OFF,HOLD,PEAK
Ctrl 3 Control Source	Controller 3 control source	1*
Ctrl 3 Peak&Hold	Controller 3 peak&hold	OFF,HOLD,PEAK

1*: OFF,SYS-CTRL1,SYS-CTRL2,MODULATION,BREATH,FOOT,VOLUME,PAN,EXPRESSION,PITCH BEND,AFTERTOUCH,LFO1,LFO2,VELOCITY,KEY-FOLLOW,PLAYMATE

Structure Display (P.49)

Parameter Name	Full Name of Parameter	Value
Structure Type 1&2	Structure type1&2	1—10
Booster 1&2	Booster gain1&2	0,+6,+12,+18
Structure Type 3&4	Structure type3&4	1—10
Booster 3&4	Booster gain3&4	0,+6,+12,+18

Tone Key Range Lower:Upper Display (P.50)

Parameter Name	Full Name of Parameter	Value
Tone 1 Lower	Tone1 key range lower	C-1—Upper
Tone 1 Upper	Tone1 key range upper	Lower—G9
Tone 2 Lower	Tone2 key range lower	C-1—Upper
Tone 2 Upper	Tone2 key range upper	Lower—G9
Tone 3 Lower	Tone3 key range lower	C-1—Upper
Tone 3 Upper	Tone3 key range upper	Lower—G9
Tone 4 Lower	Tone4 key range lower	C-1—Upper
Tone 4 Upper	Tone4 key range upper	Lower—G9

Tone Vel Range Lower:Upper:Fade Display (P.50)

Parameter Name	Full Name of Parameter	Value
Tone 1 Lower	Tone1 velocity range lower	1—Upper
Tone 1 Upper	Tone1 velocity range upper	Lower—127
Tone 1 Fade	Tone1 velocity cross fade	0—127
Tone 2 Lower	Tone2 velocity range lower	1—Upper
Tone 2 Upper	Tone2 velocity range upper	Lower—127
Tone 2 Fade	Tone2 velocity cross fade	0—127
Tone 3 Lower	Tone3 velocity range lower	1—Upper
Tone 3 Upper	Tone3 velocity range upper	Lower—127
Tone 3 Fade	Tone3 velocity cross fade	0—127
Tone 4 Lower	Tone4 velocity range lower	1—Upper
Tone 4 Upper	Tone4 velocity range upper	Lower—127
Tone 4 Fade	Tone4 velocity cross fade	0—127
Switch	Velocity range switch	OFF,ON

WG Group

Wave Param Display (P.51)

Parameter Name	Full Name of Parameter	Value
Wave Group	Wave group	INT-A,INT-B,XP-A,XP-B,XP-C,XP-D
Wave Number	Wave number	001—255
Wave Gain	Wave gain	-6,0,+6,+12
Tone Switch	Tone switch	OFF,ON
FXM Switch	FXM switch	OFF,ON
FXM Color	FXM color	1—4
FXM Depth	FXM depth	1—16
Mode	Tone delay mode	1*
Time	Tone delay time	0—127, 0—880, 0—5000 2*

1*: NORMAL,HOLD,PLAYMATE,CLOCK-SYNC,KEY-OFF-N,KEY-OFF-D,TEMPO-SYNC

2*: When the Mode parameter is set to "CLOCK-SYNC" or "TEMPO-SYNC" this is set as a Note value.

Pitch Display (P.52)

Parameter Name	Full Name of Parameter	Value
Coarse Tune	Coarse tune	-48—+48 semitone
Fine Tune	Fine tune	-50—+50 cent
Random Pitch Depth	Random pitch depth	1*
Pitch Keyfollow	Pitch keyfollow	2*-

1*: 0,1,2,3,4,5,6,7,8,9,10,20,30,40,50,60,70,80,90,100,200,300,400,500,600,700,800,900,1000,1100,1200

2*: 100,-70,-50,-30,-10,0,+10,+20,+30,+40,+50,+70,+100,+120,+150,+200

Pitch Envelope Display (P.53)

Parameter Name	Full Name of Parameter	Value
Time 1—4	Pitch envelope time 1—4	0—127
Level 1—4	Pitch envelope level 1—4	-63—+63
Envelope Depth	Pitch envelope depth	-12—+12
Velocity Sens	Pitch envelope sensitivity	-100—+150
Velocity Time1	Pitch envelope velocity time 1 sensitivity	1*
Velocity Time4	Pitch envelope velocity time 4 sensitivity	1*
Time Keyfollow	Pitch envelope time keyfollow	1*

*1: -100,-70,-50,-40,-30,-20,-10,0,+10,+20,+30,+40,+50,+70,+100

TVF Group

TVF Param Display (P.54)

Parameter Name	Full Name of Parameter	Value
Filter Type	Filter type	OFF,LPF,BPF,HPF,PKG
Cutoff Frequency	Cutoff frequency	0—127
Resonance	Resonance	0—127
Resonance Vel Sens	Resonance velocity sensitivity	-100—+150
Cutoff Keyfollow	Cutoff frequency keyfollow	1*

1*: -100,-70,-50,-30,-10,0,+10,+20,+30,+40,+50,+70,+100,+120,+150,+200

TVF Envelope Display (P.54)

Parameter Name	Full Name of Parameter	Value
Time 1—4	TVF envelope time 1—4	0—127
Level 1—4	TVF envelope level 1—4	0—127
Envelope Depth	TVF envelope depth	-63—+63
Velocity Curve	TVF envelope velocity curve	1—7
Velocity Sens	TVF envelope velocity sensitivity	-100—+150
Velocity Time1	TVF envelope velocity time1 sensitivity	1*
Velocity Time4	TVF envelope velocity time4 sensitivity	1*
Time Keyfollow	TVF envelope time keyfollow	1*

1*: -100,-70,-50,-40,-30,-20,-10,0,+10,+20,+30,+40,+50,+70,+100

TVA Group

TVA Param Display (P.55)

Parameter Name	Full Name of Parameter	Value
Tone Level	Tone level	0—127
Tone Pan	Tone pan	L64—63R
Pan Keyfollow	Pan keyfollow	1*
Random Pan Depth	Random pan depth	0—63
Alternate Pan Depth	Alternate pan depth	L63—63R
Direction	Bias direction	LOWER,UPPER, LOWER&UPPER, ALL
Position	Bias position	C-1—G9
Level	Bias level	1*

1*: -100,-70,-50,-40,-30,-20,-10,0,+10,+20,+30,+40,+50,+70,+100

TVA Envelope Display (P.56)

Parameter Name	Full Name of Parameter	Value
Time 1—4	TVA envelope time 1—4	0—127
Level 1—3	TVA envelope level 1—3	0—127
Velocity Curve	TVA envelope velocity curve	1—7
Velocity Sens	TVA envelope velocity sensitivity	-100—+150
Velocity Time1	TVA envelope velocity time1 sensitivity	1*
Velocity Time4	TVA envelope velocity time 4 sensitivity	1*
Time Keyfollow	TVA envelope time keyfollow	1*

1*: -100,-70,-50,-40,-30,-20,-10,0,+10,+20,+30,+40,+50,+70,+100

LFO&Ctl Group

LFO 1 Param Display, LFO 2 Param Display (P.57)

Parameter Name	Full Name of Parameter	Value
Waveform	LFO waveform	TRI,SIN,SAW,SQR,TRP,S&H,RND,CHS
Key Sync	LFO key sync	OFF,ON
Rate	LFO rate	0—127,0—880 (1*)
Ext Sync	LFO external sync	OFF,CLOCK
Fade Mode	LFO fade mode	KEY-ON-IN,KEY-ON-OUT,KEY-OFF-IN,KEY-OFF-OUT
Delay Time	LFO delay time	0—127
Fade Time	LFO fade time	0—127
Offset	LFO level offset	-100,-50,0,+50,+100
Pitch	Pitch LFO depth	-63—+63
Filter	Filter LFO depth	-63—+63
Level	Amplitude LFO depth	-63—+63
Pan	Pan LFO depth	-63—+63

1*: When the Ext Sync parameter is set to "CLOCK" this is set as a Note Value.

Control Param Display (P.58)

Parameter Name	Full Name of Parameter	Value
1 Control Dest	Controller 1 control destination1—4	1*
1 Depth	Controller 1 depth1—4	-63—+63
2 Control Dest	Controller 2 control destination1—4	1*
2 Depth	Controller 2 depth1—4	-63—+63
3 Control Dest	Controller 3 control destination1—4	1*
3 Depth	Controller 3 depth1—4	-63—+63

1*: OFF,PCH,CUT,RES,LEV,PAN,MIX,CHO,REV,PL1,PL2,FL1,FL2,AL1,AL2,pL1,pL2,L1R,L2R

Control Switch Display (P.59)

Parameter Name	Full Name of Parameter	Value
Volume	Volume control switch	OFF,ON
Pan	Pan control switch	OFF,CONTINUOUS,KEY-ON
Pitch Bend	Pitch bend control switch	OFF,ON
Hold-1	Hold-1 control switch	OFF,ON
Redamper	Redamper control switch	OFF,ON

Effects Group

General Display (P.60)

Parameter Name	Full Name of Parameter	Value
Output Assign	Output assign	MIX,EFX,DIR
Mix/EFX Send Level	Mix/EFX send level	0—127
Chorus Send Level	Chorus send level	0—127
Reverb Send Level	Reverb send level	0—127
EFX Type	EFX type	01—40
EFX Output Assign	EFX output assign	MIX,DIR
EFX Output Level	EFX output level	0—127
EFX Chorus Send Level	EFX Chorus send level	0—127
EFX Reverb Send Level	EFX Reverb send level	0—127

EFX Param Display (P.74)

Refer to EFX parameters

EFX Control Display (P.63)

Parameter Name	Full Name of Parameter	Value
EFX 1 Control Source	EFX 1 Control Source	1*
EFX 1 Control Depth	EFX 1 Control Depth	-63—+63
EFX 2 Control Source	EFX 2 Control Source	1*
EFX 2 Control Depth	EFX 2 Control Depth	-63—+63
EFX Ctrl Peak&Hold	EFX control source peak&hold	OFF,HOLD,PEAK

1*: OFF,SYS-CTRL1,SYS-CTRL2,MODULATION,BREATH,FOOT,VOLUME,PAN,EXPRESSION,PITCH BEND,AFTERTOUCH

Chorus Display (P.64)

Parameter Name	Full Name of Parameter	Value
Level	Chorus level	0—127
Rate	Chorus rate	0—127
Depth	Chorus depth	0—127
Pre-Delay	Chorus pre delay	0—127
Feedback	Chorus feedback level	0—127
Output	Chorus output assign	MIX,REVERB,MIX+REV

Reverb Display (P.64)

Parameter Name	Full Name of Parameter	Value
Type	Reverb/Delay type	1*
Level	Reverb/Delay level	0—127
Time	Reverb/Delay time	0—127
HF damp	Reverb/Delay HF damp	2*
Delay Feedback	Delay feedback level	0—127

1*: ROOM1,ROOM2,STAGE1,STAGE2,HALL1,HALL2,DELAY,PAN-DLY

2*: 200,250,315,400,500,630,800,1000,1250,1600,2000,2500,3150,4000,5000,6300,8000 Hz,BYPASS

Performance Parameters

Common Group

Common Display (P.65)

Parameter Name	Full Name of Parameter	Value
Performance Name	Performance name	ASCII Character (max. 12)
Key Mode	Key mode	LAYER,SINGLE
Clock Source	Performance clock source	PERFORMANCE,SEQUENCER
Performance Tempo	Performance tempo	20—250

K.Range Group

Part Key Range Lower:Upper Display (P.66)

Parameter Name	Full Name of Parameter	Value
1—16 Lower	Part1—16 Key range lower	C-1 —Upper
1—16 Upper	Part1—16Key range upper	Lower—G9
Switch	Key range switch	OFF,ON

Part Group

Part Param Display (P.66)

Parameter Name	Full Name of Parameter	Value
Patch Group	Patch Group	USER,PR-A,PR-B,PR-C,GM,XP-A,XP-B,XP-C,XP-D
Patch Number	Patch number	001—255
Part Level	Part level	0—127
Part Pan	Part pan	L64—63R
Coarse Tune	Part coarse tune	-48—+48 semitone
Fine Tune	Part fine tune	-50—+50 cent
Octave Shift	Octave shift	-3—+3
Voice Reserve	Voice reserve	0—64

MIDI Group

Part MIDI Display (P.67)

Parameter Name	Full Name of Parameter	Value
Channel	MIDI channel	1—16
Rx Switch	Receive switch	OFF,ON
Tx Switch	Transmit switch	OFF,ON
Local Switch	Local switch	OFF,ON
Rx Prog Chg Switch	Receive program change switch	OFF,ON
Rx Volume Switch	Receive volume switch	OFF,ON
Rx Hold-1 Switch	Receive Hold-1 switch	OFF,ON
Tx Bank Select	Transmit bank select group	PATCH,GROUP1—GROUP7
Tx Volume	Transmit volume	0—127,OFF

Effects Group

General Display (P.68)

Parameter Name	Full Name of Parameter	Value
Output Assign	output assign	MIX,EFX,DIR,PAT
Mix/EFX Send Level	Mix/EFX send level	0—127
Chorus Send Level	Chorus send level	0—127
Reverb Send Level	Reverb send level	0—127
EFX Type	EFX type	01—40
EFX Src	EFX source	PERFORM,PART1—PART9,PART11—PART16
EFX Output Assign	EFX output assign	MIX,DIR
EFX Output Level	EFX output level	0—127
EFX Chorus Send Level	EFX Chorus send level	0—127
EFX Reverb Send Level	EFX Reverb send level	0—127

EFX Param Display (P.74)

Refer to EFX parameters

EFX Control Display (P.63)

Parameter Name	Full Name of Parameter	Value
EFX 1 Control Source	EFX 1 control Source	1*
EFX 1 Control Depth	EFX 1 control Depth	-63—+63
EFX 2 Control Source	EFX 2 control Source	1*
EFX 2 Control Depth	EFX 2 control Depth	-63—+63
EFX Ctrl Peak&Hold	EFX control peak&hold	OFF,HOLD,PEAK

1*: OFF,SYS-CTRL1,SYS-CTRL2,MODULATION,BREATH,FOOT,VOLUME,PAN,EXPRESSION,PITCH BEND,AFTERTOUCH

Chorus Display (P.64)

Parameter Name	Full Name of Parameter	Value
Level	Chorus level	0—127
Rate	Chorus rate	0—127
Depth	Chorus depth	0—127
Pre-Delay	Chorus pre delay	0—127
Feedback	Chorus feedback level	0—127
Output	Chorus output assign	MIX,REVERB,MIX+REV

Reverb Display (P.64)

Parameter Name	Full Name of Parameter	Value
Type	Reverb/Delay type	1*
Level	Reverb/Delay level	0—127
Time	Reverb/Delay time	0—127
HF damp	Reverb/Delay HF damp	2*
Delay Feedback	Delay feedback level	0—127

1*: ROOM1,ROOM2,STAGE1,STAGE2,HALL1,HALL2,DELAY,PAN-DLY

2*: 200,250,315,400,500,630,800,1000,1250,1600,2000,2500,3150,4000,5000,6300,8000 Hz,BYPASS

Info Group

Part Information Display (P.69)

Parameter Name	Full Name of Parameter	Value
Modulation	Modulation	0—127
Breath	Breath	0—127
Foot	Foot	0—127
Volume	Volume	0—127
Pan	Pan	L64—0 -63R
Expression	Expression	0—127
Hold-1	Hold-1	0—127
Pitch Bend	Pitch Bend	-128—+127
Channel Aftertouch	Channel Aftertouch	0—127
Voices	Voices	0—127
System Control 1	System Control 1	0—127
System Control 2	System Control 2	0—127

Rhythm Set Parameters

Common Group

Rhythm Set Name Display (P.70)

Parameter Name	Full Name of Parameter	Value
Rhythm Set Name	Rhythm set name	ASCII Character (max. 12)

Key WG Group

Wave Display (P.70)

Parameter Name	Full Name of Parameter	Value
Wave Group	Wave group	INT-A,INT-B,XP-A,XP-B,XP-C,XP-D
Wave Number	Wave number	001—255
Wave Gain	Wave gain	-6,0,+6,+12
Tone Switch	Tone switch	OFF,ON
Coarse Tune	Coarse tune	C-1—G9
Fine Tune	Fine tune	-50—+50 cent
Random Pitch Depth	Random pitch depth	1*

1*: 0,1,2,3,4,5,6,7,8,9,10,20,30,40,50,60,70,80,90,100,200,300,400,500,600,700,800,900,1000,1100,1200

Pitch Envelope Display (P.70)

Parameter Name	Full Name of Parameter	Value
Time 1—4	Pitch envelope time1—4	0—127
Level 1—4	Pitch envelope level1—4	-63—+63
Envelope Depth	Pitch envelope depth	-12—+12
Velocity Sens	Pitch envelope velocity sensitivity	-100—+150
Velocity Time	Pitch envelope velocity time sensitivity	1*

1*: -100,-70,-50,-40,-30,-20,-10,0,+10,+20,+30,+40,+50,+70,+100

Key TVF Group TVF Param Display (P.71)

Parameter Name	Full Name of Parameter	Value
Filter Type	Filter type	OFF,LPF,BPF,HPF,PKG
Cutoff Frequency	Cutoff frequency	0—127
Resonance	Resonance	0—127
Resonance Vel Sens	Resonance velocity sensitivity	-100—+150

TVF Envelope Display (P.71)

Parameter Name	Full Name of Parameter	Value
Time 1—4	TVF envelope time1—4	0—127
Level 1—4	TVF envelope level1—4	0—127
Envelope Depth	TVF envelope depth	-63—+63
Velocity Sens	TVF envelope velocity sensitivity	-100—+150
Velocity Time	TVF envelope velocity time sensitivity	1*

1*: -100,-70,-50,-40,-30,-20,-10,0,+10,+20,+30,+40,+50,+70,+100

Key TVA Group TVA Param Display (P.72)

Parameter Name	Full Name of Parameter	Value
Tone Level	Rhythm tone level	0—127
Tone Pan	Rhythm tone pan	L64—63R
Random Pan Depth	Random pan depth	0—63
Alternate Pan Depth	Alternate pan depth	L63—63R

TVA Envelope Display (P.72)

Parameter Name	Full Name of Parameter	Value
Time 1—4	TVA envelope time1—4	0—127
Level 1—3	TVA envelope level1—3	0—127
Velocity Sens	TVA envelope velocity sensitivity	-100—+150
Velocity Time	TVA envelope velocity time sensitivity	1*

1*: -100,-70,-50,-40,-30,-20,-10,0,+10,+20,+30,+40,+50,+70,+100

Key Ctl Group Control Param Display (P.72)

Parameter Name	Full Name of Parameter	Value
Bend Range	Pitch bend range	0—12
Mute Group	Mute group	OFF,1—31
Envelope Mode	envelope mode	NO-SUS,SUSTAIN
Volume	Volume control switch	OFF,ON
Pan	Pan control switch	OFF,CONTINUOUS,KEY-ON
Hold-1	Hold-1 control switch	OFF,ON

Effects Group

General Display (P.73)

Parameter Name	Full Name of Parameter	Value
Output Assign	Output assign	MIX,EFX,DIR
Mix/EFX Send Level	Mix/EFX send level	0—127
Chorus Send Level	Chorus send level	0—127
Reverb Send Level	Reverb send level	0—127
EFX Type	EFX type	01—40
EFX Src	EFX source	PERFORM,PART1—PART9,PART11—PART16
EFX Output Assign	EFX output assign	MIX,DIR
EFX Output Level	EFX output level	0—127
EFX Chorus Send Level	EFX Chorus send level	0—127
EFX Reverb Send Level	EFX Reverb send level	0—127

EFX Param Display (P.74)

Refer to EFX parameters.

EFX Control Display (P.63)

Parameter Name	Full Name of Parameter	Value
EFX 1 Control Source	EFX 1 control source	1*
EFX 1 Control Depth	EFX 1 control depth	-63—+63
EFX 2 Control Source	EFX 2 control source	1*
EFX 2 Control Depth	EFX 2 control depth	-63—+63
EFX Ctrl Peak&Hold	EFX control peak&hold	OFF,HOLD,PEAK

1*: OFF,SYS-CTRL1,SYS-CTRL2,MODULATION,BREATH,FOOT,VOLUME,PAN,EXPRESSION,PITCH BEND,AFTERTOUCH

Chorus Display (P.64)

Parameter Name	Full Name of Parameter	Value
Level	Chorus level	0—127
Rate	Chorus rate	0—127
Depth	Chorus depth	0—127
Pre-Delay	Chorus pre delay	0—127
Feedback	Chorus feedback level	0—127
Output	Chorus output assign	MIX,REVERB,MIX+REV

Reverb Display (P.64)

Parameter Name	Full Name of Parameter	Value
Type	Reverb/Delay type	1*
Level	Reverb/Delay level	0—127
Time	Reverb/Delay time	0—127
HF damp	Reverb/Delay HF damp	2*
Delay Feedback	Delay feedback level	0—127

1*: ROOM1,ROOM2,STAGE1,STAGE2,HALL1,HALL2,DELAY,PAN-DLY

2*: 200,250,315,400,500,630,800,1000,1250,1600,2000,2500,3150,4000,5000,6300,8000 Hz,BYPASS

GM Parameters

Part Group

Part Param Display (P.174)

Parameter Name	Full Name of Parameter	Value
Patch Number	GM patch number	001—128
Part Volume	Part volume	0—127
Part Pan	Part pan	L64—63R
Coarse Tune	Part coarse tune	-48—+48
Fine Tune	Part fine tune	-50—+50

Effects Group

General Display (P.174)

Parameter Name	Full Name of Parameter	Value
Output Assign	output assign	MIX,EFX,DIR,PAT
Mix/EFX Send Level	Mix/EFX send level	0—127
Chorus Send Level	Chorus send level	0—127
Reverb Send Level	Reverb send level	0—127
EFX Type	EFX type	01—40
EFX Output Assign	EFX output assign	MIX,DIR
EFX Output Level	EFX output level	0—127
EFX Chorus Send Level	EFX Chorus send level	0—127
EFX Reverb Send Level	EFX Reverb send level	0—127

EFX Param Display (P.74)

Refer to EFX Parameters

EFX Control Display (P.63)

Parameter Name	Full Name of Parameter	Value
EFX 1 Control Source	EFX 1 control source	1*
EFX 1 Control Depth	EFX 1 control depth	-63—+63
EFX 2 Control Source	EFX 2 control source	1*
EFX 2 Control Depth	EFX 2 control depth	-63—+63
EFX Ctrl Peak&Hold	EFX control peak&hold	OFF,HOLD,PEAK

1*: OFF,SYS-CTRL1,SYS-CTRL2,MODULATION,BREATH,FOOT,VOLUME,PAN,EXPRESSION,PITCH BEND,AFTERTOUC

Chorus Display (P.64)

Parameter Name	Full Name of Parameter	Value
Level	Chorus level	0—127
Rate	Chorus rate	0—127
Depth	Chorus depth	0—127
Pre-Delay	Chorus pre delay	0—127
Feedback	Chorus feedback level	0—127
Output	Chorus output assign	MIX,REVERB,MIX+REV

Reverb Display (P.64)

Parameter Name	Full Name of Parameter	Value
Type	Reverb/Delay type	1*
Level	Reverb/Delay level	0—127
Time	Reverb/Delay type	0—127
HF Damp	Reverb/Delay HF damp	2*
Delay Feedback	Delay feedback level	0—127

1*: ROOM1,ROOM2,STAGE1,STAGE2,HALL1,HALL2,DELAY,PAN-DLY

2*: 200,250,315,400,500,630,800,1000,1250,1600,2000,2500,3150,4000,5000,6300,8000 Hz,BYPASS

Info Group

Part Information Display (Modulation) (P.175)

Parameter Name	Full Name of Parameter	Value
Modulation	Modulation	0—127
Breath	Breath	0—127
Foot	Foot	0—127
Volume	Volume	0—127
Pan	Pan	L64—0 -63R
Expression	Expression	0—127
Hold-1	Hold-1	0—127
Pitch Bend	Pitch Bend	-128—+127
Channel Aftertouch	Channel Aftertouch	0—127
Voices	Voices	0—127

EFX Parameters

01:STEREO-EQ (P.74)

Parameter Name	Full Name of Parameter	Value
Low Freq	Low frequency	200,400Hz
Low Gain	Low gain	-15—+15 dB
High Freq	High frequency	4000,8000Hz
High Gain	High gain	-15—+15 dB
P1 Freq	Peaking 1 frequency	200—8000 Hz *1
P1 Q	Peaking 1 Q	0.5,1.0,2.0,4.0,8.0
P1 Gain	Peaking 1 gain	-15—+15 dB
P2 Freq	Peaking 2 frequency	*1
P2 Q	Peaking 2 Q	0.5,1.0,2.0,4.0,8.0
P2 Gain	Peaking 2 gain	-15—+15 dB
Level	Output level	0—127

1*: 200, 250, 315, 400, 500, 630, 800, 1000, 1250, 1600, 2000, 2500, 3150, 4000, 5000, 6300, 8000Hz

02:OVER-DRIVE (P.74)

Parameter Name	Full Name of Parameter	Value
Drive	Drive	0—127
Amp Type	Amp simulator type	SMALL,BUILT-IN,2-STACK,3-STACK
Low Gain	Low gain	-15—+15 dB
High Gain	High gain	-15—+15 dB
Pan	Output pan	L64—0—63R
Level	Output level	0—127

03:DISTORTION (P.74)

Parameter Name	Full Name of Parameter	Value
Drive	Drive	0—127
Amp Type	Amp simulator type	SMALL,BUILT-IN,2-STACK,3-STACK
Low Gain	Low gain	-15—+15 dB
High Gain	High gain	-15—+15 dB
Pan	Output pan	L64—0—63R
Level	Output level	0—127

04:PHASER (P.75)

Parameter Name	Full Name of Parameter	Value
Manual	Manual	100— 8000 Hz
Rate	Rate	0.05—10.0 Hz
Depth	Depth	0—127
Resonance	Resonance	0—127
Mix	Mix level	0—127
Pan	Output pan	L64—0—63R
Level	Output level	0—127

05:SPECTRUM (P.75)

Parameter Name	Full Name of Parameter	Value
Band1	Band1 gain	-15—+15 dB
Band2	Band2 gain	-15—+15 dB
Band3	Band3 gain	-15—+15 dB
Band4	Band4 gain	-15—+15 dB
Band5	Band5 gain	-15—+15 dB
Band6	Band6 gain	-15—+15 dB
Band7	Band7 gain	-15—+15 dB
Band8	Band8 gain	-15—+15 dB
width	Band width	1—5
Pan	Output pan	L64—0—63R
Level	Output level	0—127

06:ENHANCER (P.75)

Parameter Name	Full Name of Parameter	Value
Sens	Sensitivity	0—127
Mix	Mix level	0—127
Low Gain	Low gain	-15—+15 dB
High Gain	High gain	-15—+15 dB
Level	Output level	0—127

07:AUTO-WAH (P.76)

Parameter Name	Full Name of Parameter	Value
Filter Type	Filter type	LPF,BPF
Sens	Sensitivity	0—127
Manual	Manual	0—127
Peak	Peak	0—127
Rate	Rate	0.05—10.0 Hz
Depth	Depth	0—127
Level	Output level	0—127

08:ROTARY (P.76)

Parameter Name	Full Name of Parameter	Value
Low Slow Rate	Low frequency slow rate	0.05—10.0Hz
Low Fast Rate	Low frequency fast rate	0.05—10.0Hz
Low Acceleration	Low frequency acceleration	0—15
Low Level	Low frequency level	0—127
High Slow Rate	High frequency slow rate	0.05—10.0Hz
High Fast Rate	High frequency fast rate	0.05—10.0Hz
High Acceleration	High frequency acceleration	0—15
High Level	High frequency level	0—127
Separation	Separation	0—127
Speed	Speed	SLOW, FAST
Level	Output level	0—127

09: COMPRESSOR (P.76)

Parameter Name	Full Name of Parameter	Value
Attack	Attack	0—127
Sustain	Sustain	0—127
Post Gain	Post gain	0, +6, +12, +18
Low Gain	Low gain	-15—+15 dB
High Gain	High gain	-15—+15 dB
Pan	Output pan	L64—0—63R
Level	Output level	0—127

10: LIMITER (P.77)

Parameter Name	Full Name of Parameter	Value
Threshold	Threshold level	0—127
Ratio	Compression ratio	1.5:1, 2:1, 4:1, 100:1
Release	Release time	0—127
Post Gain	Post gain	0, +6, +12, +18
Low Gain	Low gain	-15—+15 dB
High Gain	High gain	-15—+15 dB
Pan	Output pan	L64—0—63R
Level	Output level	0—127

11: HEXA-CHORUS (P.77)

Parameter Name	Full Name of Parameter	Value
Pre Delay	Pre delay time	0.01—100 ms
Rate	Rate	0.05—10.0Hz
Depth	Depth	0—127
Pre Delay Deviation	Pre delay deviation	0—20
Depth Deviation	Depth deviation	-20—20
Pan Deviation	Pan deviation	0—20
Balance	Effect balance	D100:0E—D0:100E
Level	Output level	0—127

12: TREMOLO-CHORUS (P.77)

Parameter Name	Full Name of Parameter	Value
Pre Delay	Pre delay time	0.01—100 ms
Chorus Rate	Chorus rate	0.05—10.0Hz
Chorus Depth	Chorus depth	0—127
Chorus Phase	Chorus phase	0—180degree
Tremolo Rate	Tremolo rate	0.05—10.0Hz
Tremolo Separation	Tremolo separation	0—127
Balance	Effect balance	D100:0E—D0:100E
Level	Output level	0—127

13: SPACE-D (P.78)

Parameter Name	Full Name of Parameter	Value
Pre Delay	Pre delay time	0.01—100 ms
Rate	Rate	0.05—10.0Hz
Depth	Depth	0—127
Phase	Phase	0—180degree
Low Gain	Low gain	-15—+15 dB
High Gain	High gain	-15—+15 dB
Balance	Effect balance	D100:0E—D0:100E
Level	Output level	0—127

14: STEREO-CHORUS (P.78)

Parameter Name	Full Name of Parameter	Value
Pre Delay	Pre delay time	0.01—100 ms
Rate	Rate	0.05—10.0Hz
Depth	Depth	0—127
Phase	Phase	0—180degree
Filter Type	Filter Type	OFF, LPF,HPF
Cutoff Freq	Cutoff frequency	1*
Low Gain	Low gain	-15—+15 dB
High Gain	High gain	-15—+15 dB
Balance	Effect balance	D100:0E—D0:100E
Level	Output level	0—127

1*: 200, 250, 315, 400, 500, 630, 800, 1000, 1250, 1600, 2000, 2500, 3150, 4000, 5000, 6300, 8000Hz

15: STEREO-FLANGER (P.78)

Parameter Name	Full Name of Parameter	Value
Pre Delay	Pre delay time	0.01—100 ms
Rate	Rate	0.05—10.0Hz
Depth	Depth	0—127
Feedback	Feedback level	-98—+98%
Phase	Phase	0—180degree
Filter Type	Filter Type	OFF,LPF,HPF
Cutoff Freq	Cutoff frequency	1*
Low Gain	Low gain	15—+15 dB
High Gain	High gain	15—+15 dB
Balance	Effect balance	D100:0E—D0:100E
Level	Output level	0—127

1*: 200, 250, 315, 400, 500, 630, 800, 1000, 1250, 1600, 2000, 2500, 3150, 4000, 5000, 6300, 8000Hz

16: STEP-FLANGER (P.79)

Parameter Name	Full Name of Parameter	Value
Pre Delay	Pre delay time	0.01—100 ms
Rate	Rate	0.05—10.0Hz
Depth	Depth	0—127
Feedback	Feedback level	-98—+98%
Phase	Phase	0—180degree
Step Rate	Step rate	0.05—10.0Hz, note
Low Gain	Low gain	-15—+15 dB
High Gain	High gain	-15—+15 dB
Balance	Effect balance	D100:0E—D0:100E
Level	Output level	0—127

17: STEREO-DELAY (P.79)

Parameter Name	Full Name of Parameter	Value
Delay Left	Delay time left	0.0—500ms
Delay Right	Delay time right	0.0—500ms
Feedback	Feedback level	-98—+98%
Feedback Mode	Feedback mode	NORMAL,CROSS
Phase Left	Feedback phase left	NORMAL,INVERT
Phase Right	Feedback phase right	NORMAL,INVERT
HF Damp	HF damp	1*
Low Gain	Low gain	-15—+15 dB
High Gain	High gain	-15—+15 dB
Balance	Effect balance	D100:0E—D0:100E
Level	Output level	0—127

1*: 200, 250, 315, 400, 500, 630, 800, 1000, 1250, 1600, 2000, 2500, 3150, 4000, 5000, 6300, 8000Hz, BYPASS

18: MODULATION-DELAY (P.80)

Parameter Name	Full Name of Parameter	Value
Delay Left	Delay time left	0.0—500ms
Delay Right	Delay time right	0.0—500ms
Feedback	Feedback level	-98—+98%
Feedback Mode	Feedback mode	NORMAL,CROSS
Rate	rate	0.05—10.0Hz
Depth	Depth	
Phase	Phase	0—180degree
HF Damp	HF damp	1*
Low Gain	Low gain	-15—+15 dB
High Gain	High gain	-15—+15 dB
Balance	Effect balance	D100:0E—D0:100E
Level	Output level	0—127

1*: 200, 250, 315, 400, 500, 630, 800, 1000, 1250, 1600, 2000, 2500, 3150, 4000, 5000, 6300, 8000Hz, BYPASS

19: TRIPLE-TAP-DELAY (P.81)

Parameter Name	Full Name of Parameter	Value
Delay Center	Delay time center	200—1000ms,note
Delay Left	Delay time left	200—1000ms,note
Delay Right	Delay time right	200—1000ms,note
Feedback	Feedback level	-98—+98%
Center Level	Center level	0—127
Left Level	Left level	0—127
Right Level	Right level	0—127
HF Damp	HF damp	1*
Low Gain	Low gain	-15—+15 dB
High Gain	High gain	-15—+15 dB
Balance	Effect balance	D100:0E—D0:100E
Level	Output level	0—127

1*: 200, 250, 315, 400, 500, 630, 800, 1000, 1250, 1600, 2000, 2500, 3150, 4000, 5000, 6300, 8000Hz, BYPASS

20: QUADRUPLE-TAP-DELAY (P.81)

Parameter Name	Full Name of Parameter	Value
Delay 1	Delay time1	200—1000ms,note
Delay 2	Delay time2	200—1000ms,note
Delay 3	Delay time3	200—1000ms,note
Delay 4	Delay time4	200—1000ms,note
Level 1	Level1	0—127
Level 2	Level2	0—127
Level 3	Level3	0—127
Level 4	Level4	0—127
Feedback	Feedback level	-98—+98%
HF Damp	HF damp	1*
Balance	Effect balance	D100:0E—D0:100E
Level	Output level	0—127

1*: 200, 250, 315, 400, 500, 630, 800, 1000, 1250, 1600, 2000, 2500, 3150, 4000, 5000, 6300, 8000Hz, BYPASS

21: TIME-CONTROL-DELAY (P.82)

Parameter Name	Full Name of Parameter	Value
Delay	Delay time	200—1000ms
Acceleration	Acceleration	0—15
Feedback	Feedback level	-98—+98%
HF Damp	HF damp	1*
Pan	Output pan	L64—0—63R
Low Gain	Low gain	-15—+15 dB
High Gain	High gain	-15—+15 dB
Balance	Effect balance	D100:0E—D0:100E
Level	Output level	0—127

1*: 200, 250, 315, 400, 500, 630, 800, 1000, 1250, 1600, 2000, 2500, 3150, 4000, 5000, 6300, 8000Hz, BYPASS

22: 2VOICE-PITCH-SHIFTER (P.82)

Parameter Name	Full Name of Parameter	Value
Coarse A	Coarse pitch A	-24—12 semitone
Fine A	Fine pitch A	-100 -100 cent
Pan A	Output pan A	L64—0—63R
Pre Delay A	Pre delay time A	0.0—500 ms
Coarse B	Coarse pitch B	-24—12 semitone
Fine B	Fine pitch B	-100 -100 cent
Pan B	Output pan B	L64—0—63R
Pre Delay B	Pre delay time B	0.0—500 ms
Mode	Pitch shifter mode	1,2,3,4,5
Level Balance	Level balance	A100:0B—A0:100B
Balance	Effect balance	D100:0E—D0:100E
Level	Output level	0—127

23: FBK-PITCH-SHIFTER (P.83)

Parameter Name	Full Name of Parameter	Value
Coarse	Coarse pitch	-24—12 semitone
Fine	Fine pitch	-100 -100 cent
Pan	Output pan	L64—0—63R
Pre Delay	Pre delay time	0.0—500 ms
Mode	Pitch shifter mode	1,2,3,4,5
Feedback	Feedback level	-98—+98%
Low Gain	Low gain	-15—+15 dB
High Gain	High gain	-15—+15 dB
Balance	Effect balance	D100:0E—D0:100E
Level	Output level	0—127

24: REVERB (P.83)

Parameter Name	Full Name of Parameter	Value
Type	Reverb type	ROOM1,ROOM2,STAGE1, STAGE2,HALL1,HALL2
Pre Delay	Pre delay time	0.0—100 ms
Time	Reverb time	0—127
HF Damp	HF damp	1*
Low Gain	Low gain	-15—+15 dB
High Gain	High gain	-15—+15 dB
Balance	Effect balance	D100:0E—D0:100E
Level	Output level	0—127

1*: 200,250,315,400,500,630,800,1000,1250,1600,2000,2500,3150,4000, 5000,6300,8000Hz,BYPASS

25: GATE-REVERB (P.84)

Parameter Name	Full Name of Parameter	Value
Type	Gate reverb type	NORMAL,REVERSE, SWEEP1,SWEEP2
Pre Delay	Pre delay time	0.0—100ms
Gate Time	Gate time	5—500ms
Low Gain	Low gain	-15—+15 dB
High Gain	High gain	-15—+15 dB
Balance	Effect balance	D100:0E—D0:100E
Level	Output level	0—127

26: OVERDRIVE → CHORUS (P.84)

Parameter Name	Full Name of Parameter	Value
OD Drive	Drive	0—127
OD Pan	Output pan	L64—0—63R
Chorus Pre Delay	Chorus pre delay time	0.0—100ms
Chorus Rate	Chorus rate	0.05—10.0Hz
Chorus Depth	Chorus depth	0—127
Chorus Balance	Chorus balance	D100:0E—D0:100E
Level	Output level	0—127

27: OVERDRIVE → FLANGER (P.84)

Parameter Name	Full Name of Parameter	Value
OD Drive	Drive	0—127
OD Pan	Output pan	L64—0—63R
Flanger Pre Delay	Flanger Pre delay time	0.0—100ms
Flanger Rate	Flanger rate	0.05—10.0Hz
Flanger Depth	Flanger depth	0—127
Flanger Feedback	Flanger feedback level	-98—+98%
Flanger Balance	Flanger balance	D100:0E—D0:100E
Level	Output level	0—127

28: OVERDRIVE → DELAY (P.85)

Parameter Name	Full Name of Parameter	Value
OD Drive	Drive	0—127
OD Pan	Output pan	L64—0—63R
Delay Time	Delay time	0.0—500ms
Delay Feedback	Delay feedback level	-98—+98%
Delay HF Damp	Delay HF damp	1*
Delay Balance	Delay balance	D100:0E—D0:100E
Level	Output level	0—127

1*: 200,250,315,400,500,630,800,1000,1250,1600,2000,2500,3150,4000, 5000,6300,8000Hz,BYPASS

29: DISTORTION → CHORUS (P.85)

Parameter Name	Full Name of Parameter	Value
OD Drive	Drive	0—127
OD Pan	Output pan	L64—0—63R
Chorus Pre Delay	Chorus pre delay time	0.0—100ms
Chorus Rate	Chorus rate	0.05—10.0Hz
Chorus Depth	Chorus depth	0—127
Chorus Balance	Chorus balance	D100:0E—D0:100E
Level	Output level	0—127

30: DISTORTION → FLANGER (P.85)

Parameter Name	Full Name of Parameter	Value
OD Drive	Drive	0—127
OD Pan	Output pan	L64—0—63R
Flanger Pre Delay	Flanger Pre delay time	0.0—100 ms
Flanger Rate	Flanger rate	0.05—10.0Hz
Flanger Depth	Flanger depth	0—127
Flanger Feedback	Flanger feedback level	-98—+98%
Flanger Balance	Flanger balance	D100:0E—D0:100E
Level	Output level	0—127

31: DISTORTION → DELAY (P.85)

Parameter Name	Full Name of Parameter	Value
OD Drive	Drive	0—127
OD Pan	Output pan	L64—0—63R
Delay Time	Delay time	0.0—500ms
Delay Feedback	Delay feedback level	-98—+98%
Delay HF Damp	Delay HF damp	1*
Delay Balance	Delay balance	D100:0E—D0:100E
Level	Output level	0—127

1*: 200,250,315,400,500,630,800,1000,1250,1600,2000,2500,3150,4000,5000,6300,8000Hz,BYPASS

32: ENHANCER → CHORUS (P.85)

Parameter Name	Full Name of Parameter	Value
EH Sens	Enhancer sensitivity	0—127
EH Mix	Enhancer mix level	0—127
Chorus Pre Delay	Chorus pre delay time	0.0—100 ms
Chorus Rate	Chorus rate	0.05—10.0Hz
Chorus Depth	Chorus depth	0—127
Chorus Balance	Chorus balance	D100:0E—D0:100E
Level	Output level	0—127

33: ENHANCER → FLANGER (P.86)

Parameter Name	Full Name of Parameter	Value
EH Sens	Enhancer sensitivity	0—127
EH Mix	Enhancer mix level	0—127
Flanger Pre Delay	Flanger Pre delay time	0.0—100ms
Flanger Rate	Flanger rate	0.05—10.0Hz
Flanger Depth	Flanger depth	0—127
Flanger Feedback	Flanger feedback level	-98—+98%
Flanger Balance	Flanger balance	D100:0E—D0:100E
Level	Output level	0—127

34: ENHANCER → DELAY (P.86)

Parameter Name	Full Name of Parameter	Value
EH Sens	Enhancer sensitivity	0—127
EH Mix	Enhancer mix level	0—127
Delay Time	Delay time	0.0—500ms
Delay Feedback	Delay feedback level	-98—+98%
Delay HF Damp	Delay HF damp	1*
Delay Balance	Delay balance	D100:0E—D0:100E
Level	Output level	0—127

1*: 200,250,315,400,500,630,800,1000,1250,1600,2000,2500,3150,4000,5000,6300,8000Hz,BYPASS

35: CHORUS → DELAY (P.86)

Parameter Name	Full Name of Parameter	Value
Chorus Pre Delay	Chorus pre delay time	0.0—100ms
Chorus Rate	Chorus rate	0.05—10.0Hz
Chorus Depth	Chorus depth	0—127
Chorus Balance	Chorus balance	D100:0E—D0:100E
Delay Time	Delay time	0.0—500ms
Delay Feedback	Delay feedback level	-98—+98%
Delay HF Damp	HF damp	1*
Delay Balance	Delay balance	D100:0E—D0:100E
Level	Output level	0—127

1*: 200,250,315,400,500,630,800,1000,1250,1600,2000,2500,3150,4000,5000,6300,8000Hz,BYPASS

36: FLANGER → DELAY (P.87)

Parameter Name	Full Name of Parameter	Value
Flanger Pre Delay	Flanger Pre delay time	0.0—100ms
Flanger Rate	Flanger rate	0.05—10.0Hz
Flanger Depth	Flanger depth	0—127
Flanger Feedback	Flanger feedback level	-98—+98%
Flanger Balance	Flanger balance	D100:0E—D0:100E
Delay Time	Delay time	0.0—500ms
Delay Feedback	Delay feedback level	-98—+98%
Delay HF Damp	Delay HF damp	1*
Delay Balance	Delay balance	D100:0E—D0:100E
Level	Output level	0—127

1*: 200,250,315,400,500,630,800,1000,1250,1600,2000,2500,3150,4000,5000,6300,8000Hz,BYPASS

37: CHORUS → FLANGER (P.87)

Parameter Name	Full Name of Parameter	Value
Chorus Pre Delay	Chorus pre delay time	0.0—100ms
Chorus Rate	Chorus rate	0.05—10.0Hz
Chorus Depth	Chorus depth	0—127
Chorus Balance	Chorus balance	D100:0E—D0:100E
Flanger Pre Delay	Flanger Pre delay time	0.0—100ms
Flanger Rate	Flanger rate	0.05—10.0Hz
Flanger Depth	Flanger depth	0—127
Flanger Feedback	Flanger feedback level	-98—+98%
Flanger Balance	Flanger balance	D100:0E—D0:100E
Level	Output level	0—127

38: CHORUS/DELAY (P.88)

Parameter Name	Full Name of Parameter	Value
Chorus Pre Delay	Chorus pre delay time	0.0—100ms
Chorus Rate	Chorus rate	0.05—10.0Hz
Chorus Depth	Chorus depth	0—127
Chorus Balance	Chorus balance	D100:0E—D0:100E
Delay Time	Delay time	0.0—500ms
Delay Feedback	Delay feedback level	-98—+98%
Delay HF Damp	HF damp	1*
Delay Balance	Delay balance	D100:0E—D0:100E
Level	Output level	0—127

1*: 200,250,315,400,500,630,800,1000,1250,1600,2000,2500,3150,4000,5000,6300,8000Hz,BYPASS

39: FLANGER/DELAY (P.88)

Parameter Name	Full Name of Parameter	Value
Flanger Pre Delay	Flanger Pre delay time	0.01—100 ms
Flanger Rate	Flanger rate	0.05—10.0Hz
Flanger Depth	Flanger depth	0—127
Flanger Feedback	Flanger feedback level	-98—+98%
Flanger Balance	Flanger balance	D100:0E—D0:100E
Delay Time	Delay time	0.0—500ms
Delay Feedback	Delay feedback level	-98—+98%
Delay HF Damp	Delay HF damp	1*
Delay Balance	Delay balance	D100:0E—D0:100E
Level	Output level	0—127

1*: 200,250,315,400,500,630,800,1000,1250,1600,2000,2500,3150,4000,5000,6300,8000Hz,BYPASS

40: CHORUS/FLANGER (P.88)

Parameter Name	Full Name of Parameter	Value
Chorus Pre Delay	Chorus pre delay time	0.01—100 ms
Chorus Rate	Chorus rate	0.05—10.0Hz
Chorus Depth	Chorus depth	0—127
Chorus Balance	Chorus balance	D100:0E—D0:100E
Flanger Pre Delay	Flanger Pre delay time	0.0—100ms
Flanger Rate	Flanger rate	0.05—10.0Hz
Flanger Depth	Flanger depth	0—127
Flanger Feedback	Flanger feedback level	-98—+98%
Flanger Balance	Flanger balance	D100:0E—D0:100E
Level	Output level	0—127

System Parameters

Setup Group

Setup Display (P.88)

Parameter Name	Full Name of Parameter	Value
LCD Contrast	LCD contrast	1—10
Patch Remain	Patch remain	ON,OFF
Power Up Mode	Power up mode	LAST-SET,DEFAULT
Character Style	Character style	TYPE1,TYPE2,TYPE3,TYPE4
Transpose Value	Transpose value	-5 (G)—+6 (F#)
Keyboard Sens	Keyboard sensitivity	LIGHT,MEDIUM,HEAVY
Keyboard Velocity	Keyboard Velocity	REAL, 1—127
Aftertouch Sens	Aftertouch sensitivity	0—100

Tune Group

Tune Display (P.89)

Parameter Name	Full Name of Parameter	Value
Master Tune	Master tune	427.4—452.6Hz
Master Key Shift	Master key shift	-12—+12 semitone
Switch	Scale tune switch	OFF,ON
Scale Tune	Scale tune C—B	-63—63 cent

MIDI Group

MIDI Param 1 Display(PERFORM) (P.90)

Parameter Name	Full Name of Parameter	Value
Performance Ctrl-Ch	Control channel	1—16,OFF
Local Switch	Local switch	OFF,ON
Remote Keyboard Sw	Remote keyboard switch	OFF,ON
Device ID Number	Device ID number	17—32
Rx Sys. Excl	Receive system exclusive message switch	OFF,ON
Tx Edit Data	Transmit edit data switch	OFF,ON
Rx GM-ON Message	Receive GM-ON switch	OFF,ON

MIDI Param 1 Display(PATCH) (P.90)

Parameter Name	Full Name of Parameter	Value
Patch Rx-Ch	Patch Receive channel	1—16,RX-CH,OFF
Patch Tx-Ch	Patch Transmit channel	1—16
Local Switch	Local switch	OFF,ON
Remote Keyboard Sw	Remote Keyboard switch	OFF,ON
Device ID Number	Device ID number	17—32
Rx Sys. Excl	Receive system exclusive message switch	OFF,ON
Tx Edit Data	Transmit edit data switch	OFF,ON
Rx GM-ON Message	Receive GM-ON switch	OFF,ON

MIDI Param 1 Display(GM) (P.91)

Parameter Name	Full Name of Parameter	Value
Local Switch	Local switch	OFF,ON
Remote Keyboard Sw	Remote Keyboard switch	OFF,ON
Device ID Number	Device ID number	17—32
Rx GM-ON Message	Receive GM-ON switch	OFF,ON

MIDI Param 2 Display (P.91)

Parameter Name	Full Name of Parameter	Value
Rx Program Change	Receive program change switch	OFF,ON
Rx Bank Select	Receive bank select switch	OFF,ON
Tx Program Change	Transmit program change switch	OFF,ON
Tx Bank Select	Transmit bank select switch	OFF,ON
Tx Active Sensing	Transmit active sensing switch	OFF,ON

Bank Select Group Display (P.91)

Parameter Name	Full Name of Parameter	Value
<Grp1>—<Grp7> Switch	Grp1—<Grp7 Transmit bank select switch	OFF,ON
<Grp1>—<Grp7> Bank MSB	Grp1—<Grp7 Transmit bank select MSB	0—127
<Grp1>—<Grp7> Bank LSB	Grp1—<Grp7 Transmit bank select LSB	0—127

Control Group Control Assign Display (P.92)

Parameter Name	Full Name of Parameter	Value
C1 Slider <Assign>	C1 slider assign	1*
C1 Slider <Output>	C1 slider output	OFF,INT,MIDI,INT&MIDI
C2 Slider <Assign>	C2 slider assign	1*
C2 Slider <Output>	C2 slider output	OFF,INT,MIDI,INT&MIDI
Sys-Ctrl 1 <Assign>	System controller 1 assign	1*
Sys-Ctrl 2 <Assign>	System controller 2 assign	1*

1*: CC01—CC05,CC07—CC31,CC64—CC95,PITCH BEND,AFTERTOUCH

Pedal Assign Display (P.92)

Parameter Name	Full Name of Parameter	Value
Pedal 1—4 <Assign>	Pedal1—4 assign	1*
Pedal 1—4 <Output>	Pedal1—4 output	OFF,INT,MIDI,INT&MIDI
Pedal 1—4 <Polarity>	Pedal1—4 polarity	STANDARD,REVERSE
Hold Pedal <Output>	Hold pedal output	OFF,INT,MIDI,INT&MIDI
Hold Pedal <Polarity>	Hold pedal polarity	STANDARD,REVERSE

1*: CC01—CC05,CC07—CC31,CC64—CC95,PITCH BEND,AFTERTOUCH,PROG-UP,PROG-DOWN,START/STOP,PUNCH-I/O,TAP-TEMPO,OCT-UP,OCT-DOWN

Control Source Display (P.93)

Parameter Name	Full Name of Parameter	Value
Hold	Hold control source	OFF,HOLD-1,SOSTENUTO,SOFT,HOLD-2
Peak	Peak control source	OFF,HOLD-1,SOSTENUTO,SOFT,HOLD-2
Volume	Volume control source	VOLUME,VOL&EXP
Aftertouch Source	Aftertouch control source	CHANNEL,POLY,CH&POLY

Arpeg Group Arpeggio Display (P.94)

Parameter Name	Full Name of Parameter	Value
Style	Style	1*
Motif	Motif	2*
Beat Pattern	Beat Pattern	3*
Accent Rate	Accent rate	0—100
Shuffle Rate	Shuffle rate	50—90
Octave Range	Octave range	-3—+3
Key Velocity	Key velocity	REAL,1—127
Part	Arpeggio part	1-16
Tempo (=SEQ)	Tempo	10—250
Arpeggio Window	Arpeggio window	ENABLE,DISABLE

1*: 1/4,1/6,1/8,1/12,1/16,1/32,GLISSANDO,SEQUENCE A,SEQUENCE B,SEQUENCE C,ECHO,SYNTH BASS,SLAP BASS A,SLAP BASS B,WALK BASS,RHYTHM GTR A,RHYTHM GTR B,RHYTHM GTR C,RHYTHM GTR D,RHYTHM GTR E,3 FINGER GTR,STRUMMING GTR,KBD COMPING A,KBD COMPING B,KBD COMPING C,KBD COMPING D,KBD COMPING E,PERCUSSION,HARP,SHAMISEN,BOUND BALL,RANDOM,LIMITLESS

2*: SINGLE UP,SINGLE DOWN,SINGLE UP&DOWN,SINGLE RANDOM,DUAL UP,DUAL DOWN,DUAL UP&DOWN,DUAL RANDOM,NOTE ORDER,GLISSANDO,CHORD,BASS+CHORD1—5,BASS+UP1—8,BASS+RANDOM1—3,TOP+UP1—6,BASS+UP+TOP

3*: 1/4,1/6,1/8,1/12,1/16 1—3,1/32 1—3,SEQ-A 1—7,SEQ-B 1—4,SEQ-C 1—2,ECHO 1—3,MUTE 01—16,STRUM1—8,REGGAE,REFRAIN1—2,PERC1—4,WALKBS,HARP,BOUND,RANDOM

Factory Preset Settings

Waveform List

*: Waveforms marked "***" are One-shot type waveforms (non-sustaining).

INT-A (Internal A)

No.	Name	No.	Name	No.	Name	No.	Name	No.	Name
001	Ac Piano1 A	052	Nylon Gtr A	103	Syn Gtr B	154	MC-202 Bs B	205	Cello A
002	Ac Piano1 B	053	Nylon Gtr B	104	Syn Gtr C	155	MC-202 Bs C	206	Cello B
003	Ac Piano1 C	054	Nylon Gtr C	105	Harp 1A	156	Flute 1A	207	Cello C
004	Ac Piano2 pA	055	6-Str Gtr A	106	Harp 1B	157	Flute 1B	208	ST.Strings-R
005	Ac Piano2 pB	056	6-Str Gtr B	107	Harp 1C	158	Flute 1C	209	ST.Strings-L
006	Ac Piano2 pC	057	6-Str Gtr C	108	Banjo A	159	Blow Pipe	210	MonoStringsA
007	Ac Piano2 fA *	058	Gtr Harm A	109	Banjo B	160	Bottle	211	MonoStringsC
008	Ac Piano2 fB *	059	Gtr Harm B	110	Banjo C	161	Shakuhachi	212	Pizz *
009	Ac Piano2 fC *	060	Gtr Harm C	111	Sitar A	162	Clarinet A	213	JP Strings1A
010	Piano Thump *	061	Comp Gtr A	112	Sitar B	163	Clarinet B	214	JP Strings1B
011	Piano Up TH *	062	Comp Gtr B	113	Sitar C	164	Clarinet C	215	JP Strings1C
012	MKS-20 P3 A	063	Comp Gtr C	114	Dulcimer A	165	Oboe mf A	216	JP Strings2A
013	MKS-20 P3 B	064	Comp Gtr A+	115	Dulcimer B	166	Oboe mf B	217	JP Strings2B
014	MKS-20 P3 C	065	Mute Gtr 1	116	Dulcimer C	167	Oboe mf C	218	JP Strings2C
015	SA Rhodes 1A	066	Mute Gtr 2A	117	Shamisen A	168	Sop.Sax mf A	219	Soft Pad A
016	SA Rhodes 1B	067	Mute Gtr 2B	118	Shamisen B	169	Sop.Sax mf B	220	Soft Pad B
017	SA Rhodes 1C	068	Mute Gtr 2C	119	Shamisen C	170	Sop.Sax mf C	221	Soft Pad C
018	SA Rhodes 2A	069	Pop Strat A	120	Koto A	171	Alto Sax 1A	222	Fantasyth A
019	SA Rhodes 2B	070	Pop Strat B	121	Koto B	172	Alto Sax 1B	223	Fantasyth B
020	SA Rhodes 2C	071	Pop Strat C	122	Koto C	173	Alto Sax 1C	224	Fantasyth C
021	E.Piano 1A	072	Jazz Gtr A	123	Pick Bass A	174	Tenor Sax A	225	D-50 HeavenA
022	E.Piano 1B	073	Jazz Gtr B	124	Pick Bass B	175	Tenor Sax B	226	D-50 HeavenB
023	E.Piano 1C	074	Jazz Gtr C	125	Pick Bass C	176	Tenor Sax C	227	D-50 HeavenC
024	E.Piano 2A	075	JC Strat A	126	Fingerd Bs A	177	Bari.Sax f A	228	Fine Wine
025	E.Piano 2B	076	JC Strat B	127	Fingerd Bs B	178	Bari.Sax f B	229	D-50 Brass A
026	E.Piano 2C	077	JC Strat C	128	Fingerd Bs C	179	Bari.Sax f C	230	D-50 Brass B
027	E.Piano 3A	078	JC Strat A+	129	E.Bass	180	Harmonica A	231	D-50 Brass C
028	E.Piano 3B	079	JC Strat B+	130	Fretless A	181	Harmonica B	232	D-50 BrassA+
029	E.Piano 3C	080	JC Strat C+	131	Fretless B	182	Harmonica C	233	DualSquare A
030	MK-80 EP A	081	Clean Gtr A	132	Fretless C	183	Chanter	234	DualSquare C
031	MK-80 EP B	082	Clean Gtr B	133	UprightBs 1	184	Tpt Sect. A	235	DualSquareA+
032	MK-80 EP C	083	Clean Gtr C	134	UprightBs 2A	185	Tpt Sect. B	236	Pop Voice
033	D-50 EP A	084	Stratus A	135	UprightBs 2B	186	Tpt Sect. C	237	Syn Vox 1
034	D-50 EP B	085	Stratus B	136	UprightBs 2C	187	Trumpet 1A	238	Syn Vox 2
035	D-50 EP C	086	Stratus C	137	Slap Bass 1	188	Trumpet 1B	239	Voice Aahs A
036	Celesta	087	OD Gtr A	138	Slap & Pop	189	Trumpet 1C	240	Voice Aahs B
037	Music Box	088	OD Gtr B	139	Slap Bass 2	190	Trumpet 2A	241	Voice Aahs C
038	Clav 1A	089	OD Gtr C	140	Slap Bass 3	191	Trumpet 2B	242	Voice Oohs1A
039	Clav 1B	090	OD Gtr A+	141	Jz.Bs Thumb	192	Trumpet 2C	243	Voice Oohs1B
040	Clav 1C	091	Heavy Gtr A	142	Jz.Bs Slap 1	193	HarmonMute1A	244	Voice Oohs1C
041	Organ 1	092	Heavy Gtr B	143	Jz.Bs Slap 2	194	HarmonMute1B	245	Voice Oohs2A
042	Jazz Organ 1	093	Heavy Gtr C	144	Jz.Bs Slap 3	195	HarmonMute1C	246	Voice Oohs2B
043	Jazz Organ 2	094	Heavy Gtr A+	145	Jz.Bs Pop	196	Trombone 1	247	Voice Oohs2C
044	Organ 2	095	Heavy Gtr B+	146	Syn Bass A	197	French 1A	248	Voice Breath
045	Organ 3	096	Heavy Gtr C+	147	Syn Bass C	198	French 1C	249	Male Ooh A
046	Organ 4	097	PowerChord A	148	Mini Bs 1A	199	F.Horns A	250	Male Ooh B
047	Rock Organ	098	PowerChord B	149	Mini Bs 1B	200	F.Horns B	251	Male Ooh C
048	Dist. Organ	099	PowerChord C	150	Mini Bs 1C	201	F.Horns C	252	Org Vox A
049	Rot.Org Slw	100	EG Harm	151	Mini Bs 2	202	Violin A	253	Org Vox B
050	Rot.Org Fst	101	Gt.FretNoise *	152	Mini Bs 2+	203	Violin B	254	Org Vox C
051	Pipe Organ	102	Syn Gtr A	153	MC-202 Bs A	204	Violin C	255	Vox Noise

INT-B (Internal B)

No.	Name	No.	Name	No.	Name	No.	Name
001	Kalimba	052	Feedbackwave	103	Cowbell 1	*	154 REV 606HH Op *
002	Marimba Wave	053	Spectrum	104	Wood Block	*	155 REV Ride
003	Log Drum	054	BreathNoise *	105	Claves	*	156 REV Cup
004	Vibes	055	Rattles	106	Bongo Hi	*	157 REV Crash 1 *
005	Bottle Hit	056	Ice Rain	107	Bongo Lo	*	158 REV China *
006	Glockenspiel	057	Tin Wave	108	Cga Open Hi	*	159 REV DrySick *
007	Tubular	058	Anklungs	109	Cga Open Lo	*	160 REV RealCLP *
008	Steel Drums	059	Wind Chimes	110	Cga Mute Hi	*	161 REV FingSnap *
009	Fanta Bell A	060	Orch. Hit *	111	Cga Mute Lo	*	162 REV Cowbell *
010	Fanta Bell B	061	Tekno Hit *	112	Cga Slap	*	163 REV WoodBlck *
011	Fanta Bell C	062	Back Hit *	113	Timbale	*	164 REV Clve *
012	FantaBell A+	063	Philly Hit *	114	Cabasa Up	*	165 REV Conga *
013	Org Bell	064	Scratch 1 *	115	Cabasa Down	*	166 REV Tamb *
014	Agogo	065	Scratch 2	116	Cabasa Cut	*	167 REV Maracas *
015	DIGI Bell 1	066	Scratch 3 *	117	Maracas	*	168 REV Guiro *
016	DIGI Bell 1+	067	Natural SN1 *	118	Long Guiro	*	169 REV Cuica *
017	DIGI Chime	068	Natural SN2 *	119	Tambourine	*	170 REV Metro *
018	Wave Scan	069	Piccolo SN *	120	Open Triangl		171 Loop 1
019	Wire String	070	Ballad SN *	121	Cuica	*	172 Loop 2
020	2.2 Bellwave	071	SN Roll *	122	Vibraslap		173 Loop 3
021	2.2 Vibwave	072	808 SN *	123	Timpani		174 Loop 4
022	Spark VOX	073	Brush Slap *	124	Applause		175 Loop 5
023	MMM VOX	074	Brush Swish *	125	REV Orch.Hit *		176 Loop 6
024	Lead Wave	075	Brush Roll	126	REV TeknoHit *		177 Loop 7
025	Synth Reed	076	Dry Stick *	127	REV Back Hit *		178 R8 Click *
026	Synth Saw 1	077	Side Stick *	128	REV PhillHit *		179 Metronome 1
027	Synth Saw 2	078	Lite Kick *	129	REV Steel DR		180 Metronome 2 *
028	Syn Saw 2inv	079	Hybrid Kick1 *	130	REV Tin Wave		181 MC500 Beep 1 *
029	Synth Saw 3	080	Hybrid Kick2 *	131	REV NatrlSN1 *		182 MC500 Beep 2 *
030	JP-8 Saw A	081	Old Kick *	132	REV NatrlSN2 *		183 Low Saw
031	JP-8 Saw B	082	Verb Kick *	133	REV PiccloSN *		184 Low Saw inv
032	JP-8 Saw C	083	Round Kick *	134	REV BalladSN *		185 Low P5 Saw
033	P5 Saw A	084	808 Kick	135	REV Side Stk *		186 Low Pulse 1
034	P5 Saw B	085	Verb Tom Hi *	136	REV SN Roll *		187 Low Pulse 2
035	P5 Saw C	086	Verb Tom Lo *	137	REV Brush 1 *		188 Low Square
036	D-50 Saw A	087	Dry Tom Hi	138	REV Brush 2 *		189 Low Sine
037	D-50 Saw B	088	Dry Tom Lo	139	REV Brush 3		190 Low Triangle
038	D-50 Saw C	089	Cl HiHat 1 *	140	REV LiteKick *		191 Low White NZ
039	Synth Square	090	Cl HiHat 2 *	141	REV HybridK1 *		192 Low Pink NZ
040	JP-8 SquareA	091	Op HiHat	142	REV HybridK2 *		193 DC
041	JP-8 SquareB	092	Pedal HiHat *	143	REV Old Kick *		
042	JP-8 SquareC	093	606 HiHat Cl *	144	REV Timpani *		
043	Synth Pulse1	094	606 HiHat Op *	145	REV VerbTomH *		
044	Synth Pulse2	095	808 Claps *	146	REV VerbTomL *		
045	Triangle	096	Hand Claps *	147	REV DryTom H		
046	Sine	097	Finger Snaps *	148	REV DryTom M		
047	Org Click *	098	Ride 1	149	REV ClHiHat1 *		
048	White Noise	099	Ride 2	150	REV ClHiHat2 *		
049	Pink Noise	100	Ride Bell 1	151	REV Op HiHat *		
050	Metal Wind	101	Crash 1	152	REV Pedal HH *		
051	Wind Agogo	102	China Cym	153	REV 606HH Cl *		

Patch List

Voice: number of voice

USER (User Group)

PR-A (Preset A Group)

No.	Name	Voice	Key Assign	No.	Name	Voice	Key Assign	No.	Name	Voice	Key Assign	No.	Name	Voice	Key Assign
001	West Coast	4	POLY	065	St.Strings	2	POLY	001	64voicePiano	1	POLY	065	Dual Profs	3	POLY
002	Mission LFO	4	POLY	066	AmbienceVibe	4	POLY	002	Bright Piano	1	POLY	066	Saw Mass	4	POLY
003	Dusk 2 Dawn	4	POLY	067	LFO Strings	2	POLY	003	Classique	2	POLY	067	Poly Split	4	POLY
004	Purple Spin	4	POLY	068	AltoLead Sax	3	POLY	004	Nice Piano	3	POLY	068	Poly Brass	3	POLY
005	20 Years ago	3	POLY	069	Jet Pad 2	2	POLY	005	Piano Thang	3	POLY	069	Stackoid	4	POLY
006	Symphonique	4	POLY	070	Childlike	4	POLY	006	Power Grand	3	POLY	070	Poly Rock	4	POLY
007	Clear Guitar	3	POLY	071	D-50 Stack2	4	POLY	007	House Piano	2	POLY	071	D-50 Stack	4	POLY
008	Gamelan v/s.	4	POLY	072	Pulse Key	3	POLY	008	E.Grand	1	POLY	072	Fantasia JV	4	POLY
009	Cyber Swing1	4	POLY	073	Velo-Wah Gtr	1	POLY	009	MIDled Grand	3	POLY	073	Jimmee Dee	4	POLY
010	Taj Mahal	1	POLY	074	3D-Space	4	POLY	010	Piano Blend	3	POLY	074	Heavenals	4	POLY
011	Resosaw Bass	2	POLY	075	Sitar	2	POLY	011	West Coast	4	POLY	075	Mallet Pad	4	POLY
012	Impact	4	POLY	076	Big BPF	4	POLY	012	PianoStrings	4	POLY	076	Huff N Stuff	3	POLY
013	Rock It !!!	2	POLY	077	Plik-Plok	2	POLY	013	Bs/Pno+Brs	4	POLY	077	Puff 1080	2	POLY
014	Vocal Phrase	3	POLY	078	PsychoRhodes	2	POLY	014	Waterhodes	2	POLY	078	BellVox 1080	4	POLY
015	Raverborg	4	POLY	079	Bass Marimba	4	POLY	015	S.A.E.P.	3	POLY	079	Fantasy Vox	4	POLY
016	ORBit Pad	2	POLY	080	MandolinTrem	4	POLY	016	SA Rhodes 1	4	POLY	080	Square Keys	2	POLY
017	Bs/Pno+Brs	4	POLY	081	Poly Saws	4	POLY	017	SA Rhodes 2	2	POLY	081	Childlike	4	POLY
018	Clarinet mp	1	POLY	082	Pulse Pad	4	POLY	018	Stiky Rhodes	3	POLY	082	Music Box	3	POLY
019	Aurora	4	POLY	083	Nylon Gtr	1	POLY	019	Dig Rhodes	2	POLY	083	Toy Box	2	POLY
020	Nice Piano	3	POLY	084	Majestic Tpt	1	SOLO	020	Nylon EPiano	4	POLY	084	Wave Bells	4	POLY
021	Heirborne	4	POLY	085	Terminate	3	POLY	021	Nylon Rhodes	4	POLY	085	Tria Bells	4	POLY
022	ChamberWoods	3	POLY	086	SquareLead 1	3	POLY	022	Rhodes Mix	3	POLY	086	Beauty Bells	4	POLY
023	Raggatronic	4	POLY	087	House Piano	2	POLY	023	PsychoRhodes	2	POLY	087	Music Bells	2	POLY
024	PCMEFXHEAVY	2	POLY	088	Fooled Again	1	POLY	024	Tremo Rhodes	4	POLY	088	Pretty Bells	2	POLY
025	LetterFrmPat	4	POLY	089	Pick Bass	1	SOLO	025	MK-80 Rhodes	1	POLY	089	Pulse Key	3	POLY
026	Hillbillys	4	POLY	090	Wide Tubular	4	POLY	026	MK-80 Phaser	1	POLY	090	Wide Tubular	4	POLY
027	Gospel Spin	3	POLY	091	Velo-Rez Clv	1	POLY	027	Delicate EP	2	POLY	091	AmbienceVibe	4	POLY
028	Biosphere	2	POLY	092	Delicate EP	2	POLY	028	Octa Rhodes1	4	POLY	092	Warm Vibes	2	POLY
029	JUNO Strings	3	POLY	093	Velo Tekno 1	3	SOLO	029	Octa Rhodes2	4	POLY	093	Dyna Marimba	1	POLY
030	System 100m	3	POLY	094	Running Pad	4	POLY	030	JV Rhodes+	4	POLY	094	Bass Marimba	4	POLY
031	Tortured	4	POLY	095	Archimede	3	POLY	031	EP+Mod Pad	4	POLY	095	Nomad Perc	3	POLY
032	Flying Waltz	4	POLY	096	Stage EGrand	4	POLY	032	Mr.Mellow	4	POLY	096	Ethno Metals	4	POLY
033	Sop.Sax mf	2	POLY	097	Nylon Rhodes	4	POLY	033	Comp Clav	1	POLY	097	Islands Mlt	4	POLY
034	Dist TB-303	2	SOLO	098	1key Chord	3	POLY	034	Klavinet	4	POLY	098	Steelin Keys	3	POLY
035	Ring EP	3	POLY	099	Finger Bass	1	SOLO	035	Winger Clav	4	POLY	099	Steel Drums	1	POLY
036	Rezoid	4	POLY	100	Slow Voices	3	POLY	036	Phaze Clav 1	2	POLY	100	Voicery Pizz	3	POLY
037	JC Strat	1	POLY	101	4 Hits 4 You	4	POLY	037	Phaze Clav 2	1	POLY	101	Sitar	2	POLY
038	Blade Racer	4	POLY	102	Brass Sect	4	POLY	038	Phuzz Clav	2	POLY	102	Drone Split	4	POLY
039	PWM Strings	3	POLY	103	Sqr Organ	2	POLY	039	Chorus Clav	1	POLY	103	Ethnopluck	4	POLY
040	Brass Orch.	3	POLY	104	Atmosfear	3	POLY	040	Claviduck	2	POLY	104	Jamisen	2	POLY
041	Alternative	2	SOLO	105	Tenor Sax	4	POLY	041	Velo-Rez Clv	1	POLY	105	Dulcimer	2	POLY
042	FM Bells	3	POLY	106	Acid 404	1	SOLO	042	Clavicembalo	4	POLY	106	East Melody	2	POLY
043	Saw Mass	4	POLY	107	Mellow Bars	4	POLY	043	Analog Clav1	1	POLY	107	MandolinTrem	4	POLY
044	Steel Away	3	POLY	108	Raver Clav	1	POLY	044	Analog Clav2	1	POLY	108	Nylon Gtr	1	POLY
045	Poly Pulse	4	POLY	109	Air Lead	2	POLY	045	Metal Clav	3	POLY	109	Gtr Strings	3	POLY
046	Velo Tekno 2	2	POLY	110	Raya Shaku	3	POLY	046	Full Stops	2	POLY	110	Steel Away	3	POLY
047	Tone Wh.Solo	3	POLY	111	Greek Power	4	POLY	047	Ballad B	3	POLY	111	Heavenly Gtr	4	POLY
048	Thin Dist.	1	POLY	112	Pure Tibet	1	POLY	048	Mellow Bars	4	POLY	112	12str Gtr 1	2	POLY
049	JP-8Haunting	4	POLY	113	Wavin Strngs	2	POLY	049	AugerMentive	3	POLY	113	12str Gtr 2	3	POLY
050	Jz Gtr Hall	1	POLY	114	Chambers	3	POLY	050	Perky B	2	POLY	114	Jz Gtr Hall	1	POLY
051	Vanishing	1	POLY	115	Nomad Perc	3	POLY	051	The Big Spin	3	POLY	115	LetterFrmPat	4	POLY
052	Harmonica	2	POLY	116	Horn Swell	4	POLY	052	Gospel Spin	3	POLY	116	Jazz Scat	3	POLY
053	Wave Bells	4	POLY	117	Claviduck	2	POLY	053	Roller Spin	3	POLY	117	Lounge Gig	3	POLY
054	Film Octaves	4	POLY	118	Night Shade	4	POLY	054	Rocker Spin	3	POLY	118	JC Strat	1	POLY
055	Sawteeth	3	SOLO	119	VOX Flute	4	POLY	055	Tone Wh.Solo	3	POLY	119	Twin Strats	3	POLY
056	AugerMentive	3	POLY	120	Dark Vox	2	POLY	056	Purple Spin	4	POLY	120	JV Strat	2	POLY
057	JD Ghostrngs	4	POLY	121	Bass Pizz	4	POLY	057	60's LeadORG	2	POLY	121	Syn Strat	2	POLY
058	SA Rhodes 1	4	POLY	122	Full Orchest	4	POLY	058	Assalt Organ	3	POLY	122	Rotary Gtr	2	POLY
059	3D Flanged	1	POLY	123	esreveR	3	POLY	059	D-50 Organ	2	POLY	123	Muted Gtr	1	POLY
060	Ac.Upright	1	SOLO	124	Loop Str	4	POLY	060	Cathedral	4	POLY	124	SwitchOnMute	2	POLY
061	Poly Brass	3	POLY	125	12str Gtr 1	2	POLY	061	Church Pipes	4	POLY	125	Power Trip	2	POLY
062	Stepped Pad	4	POLY	126	Gone withe W	3	POLY	062	Poly Key	3	POLY	126	Crunch Split	4	POLY
063	Sax Section	4	POLY	127	Trance Pad 1	2	POLY	063	Poly Saws	4	POLY	127	Rezodrive	2	SOLO
064	Albion	2	POLY	128	Fantasy Vox	4	POLY	064	Poly Pulse	4	POLY	128	RockYurSocks	4	SOLO

PR-B (Preset B Group)

PR-C (Preset C Group)

No.	Name	Voice	Key	Assign	No.	Name	Voice	Key	Assign	No.	Name	Voice	Key	Assign	No.	Name	Voice	Key	Assign
001	Dist Gtr 1	3	POLY		065	Analog Seq	2	POLY		001	Harmon Mute	1	POLY		065	Harmonicum	2	POLY	
002	Dist Gtr 2	3	POLY		066	Impact Vox	4	POLY		002	Tp&Sax Sect	4	POLY		066	D-50 Heaven	2	POLY	
003	R&R Chunk	4	POLY		067	TeknoSoloVox	2	POLY		003	Sax+Tp+Tb	3	POLY		067	Afro Horns	3	POLY	
004	Phripphuzz	1	SOLO		068	X-Mod Man	2	POLY		004	Brass Sect	4	POLY		068	Pop Pad	4	POLY	
005	Grungeroni	3	POLY		069	Paz <=> Zap	1	SOLO		005	Trombone	1	POLY		069	Dreamesque	4	POLY	
006	Black Widow	4	POLY		070	4 Hits 4 You	4	POLY		006	Hybrid Bones	4	POLY		070	Square Pad	4	POLY	
007	Velo-Wah Gtr	1	POLY		071	Impact	4	POLY		007	Noble Horns	4	POLY		071	JP-8 Hollow	4	POLY	
008	Mod-Wah Gtr	2	POLY		072	Phase Hit	3	POLY		008	Massed Horns	3	POLY		072	JP-8Haunting	4	POLY	
009	Pick Bass	1	SOLO		073	Tekno Hit 1	2	POLY		009	Horn Swell	4	POLY		073	Heirborne	4	POLY	
010	Hip Bass	2	POLY		074	Tekno Hit 2	2	POLY		010	Brass It!	4	POLY		074	Hush Pad	4	POLY	
011	Perc.Bass	3	SOLO		075	Tekno Hit 3	4	POLY		011	Brass Attack	3	POLY		075	Jet Pad 1	2	POLY	
012	Honey Bass	2	SOLO		076	Reverse Hit	3	POLY		012	Archimede	3	POLY		076	Jet Pad 2	2	POLY	
013	Finger Bass	1	SOLO		077	SquareLead 1	3	POLY		013	Rugby Horn	3	POLY		077	Phaze Pad	3	POLY	
014	Nylon Bass	2	POLY		078	SquareLead 2	2	POLY		014	MKS-80 Brass	2	POLY		078	Phaze Str	4	POLY	
015	Ac.Upright	1	SOLO		079	You and Luck	2	SOLO		015	True ANALOG	2	POLY		079	Jet Str Ens	2	POLY	
016	Wet Fretls	1	SOLO		080	Belly Lead	4	POLY		016	Dark Vox	2	POLY		080	Pivotal Pad	4	POLY	
017	Fretls Dry	2	POLY		081	WhistlinAtom	2	POLY		017	RandomVowels	4	POLY		081	3D Flanged	1	POLY	
018	Slap Bass 1	2	POLY		082	Edye Boost	2	SOLO		018	Angels Sing	2	POLY		082	Fantawine	4	POLY	
019	Slap Bass 2	1	SOLO		083	MG Solo	4	SOLO		019	Pvox Oooze	3	POLY		083	Glassy Pad	3	POLY	
020	Slap Bass 3	1	SOLO		084	FXM Saw Lead	4	SOLO		020	Longing...	3	POLY		084	Moving Glass	1	POLY	
021	Slap Bass 4	2	POLY		085	Sawteeth	3	SOLO		021	Arasian Morn	4	POLY		085	Glasswaves	3	POLY	
022	4 Pole Bass	1	SOLO		086	Smoothe	2	SOLO		022	Beauty Vox	3	POLY		086	Shiny Pad	4	POLY	
023	Tick Bass	4	SOLO		087	MG Lead	2	SOLO		023	Mary-AnneVox	4	POLY		087	ShiftedGlass	2	POLY	
024	House Bass	3	SOLO		088	MG Interval	4	SOLO		024	Belltree Vox	4	POLY		088	Chime Pad	3	POLY	
025	Mondo Bass	3	SOLO		089	Pulse Lead 1	3	POLY		025	Vox Panner	2	POLY		089	Spin Pad	2	POLY	
026	Clk AnalogBs	2	SOLO		090	Pulse Lead 2	4	SOLO		026	Spaced Voxx	4	POLY		090	Rotary Pad	4	POLY	
027	Bass In Face	2	POLY		091	Little Devil	4	SOLO		027	Glass Voices	3	POLY		091	Dawn 2 Dusk	3	POLY	
028	101 Bass	2	SOLO		092	Loud SynLead	4	SOLO		028	Tubular Vox	4	POLY		092	Aurora	4	POLY	
029	Noiz Bass	2	SOLO		093	Analog Lead	2	SOLO		029	Velo Voxx	2	POLY		093	Strobe Mode	4	POLY	
030	Super Jup Bs	2	POLY		094	5th Lead	2	SOLO		030	Wavox	3	POLY		094	Albion	2	POLY	
031	Occitan Bass	3	POLY		095	Flute	2	POLY		031	Doos	1	POLY		095	Running Pad	4	POLY	
032	Hugo Bass	4	SOLO		096	Piccolo	1	POLY		032	Synvox Comps	4	POLY		096	Stepped Pad	4	POLY	
033	Multi Bass	2	POLY		097	VOX Flute	4	POLY		033	Vocal Oohz	3	POLY		097	Random Pad	4	POLY	
034	Moist Bass	2	SOLO		098	Air Lead	2	POLY		034	LFO Vox	1	POLY		098	SoundtrkDANC	4	POLY	
035	BritelowBass	4	SOLO		099	Pan Pipes	2	POLY		035	St.Strings	2	POLY		099	Flying Waltz	4	POLY	
036	Untamed Bass	3	SOLO		100	Airplaaane	4	POLY		036	Warm Strings	4	POLY		100	Vanishing	1	POLY	
037	Rubber Bass	3	SOLO		101	Taj Mahal	1	POLY		037	Somber Str	4	POLY		101	5th Sweep	4	POLY	
038	Stereoww Bs	3	SOLO		102	Raya Shaku	3	POLY		038	Marcato	2	POLY		102	Phazweep	4	POLY	
039	Wonder Bass	3	SOLO		103	Oboe mf	1	POLY		039	Bright Str	2	POLY		103	Big BPF	4	POLY	
040	Deep Bass	2	POLY		104	Oboe Express	2	POLY		040	String Ens	4	POLY		104	MG Sweep	4	POLY	
041	Super JX Bs	2	SOLO		105	Clarinet mp	1	POLY		041	TremoloStrng	2	POLY		105	CeremonyTimp	3	POLY	
042	W<RED>-Bass	4	POLY		106	ClariExpress	2	POLY		042	Chambers	3	POLY		106	Dyno Toms	4	POLY	
043	HI-Ring Bass	3	POLY		107	Mitzva Split	4	POLY		043	ViolinCello	4	POLY		107	Sands ofTime	4	POLY	
044	Euro Bass	2	SOLO		108	ChamberWinds	4	POLY		044	Symphonique	4	POLY		108	Inertia	4	POLY	
045	SinusoidRave	1	SOLO		109	ChamberWoods	3	POLY		045	Film Octaves	4	POLY		109	Vektogram	4	POLY	
046	Alternative	2	SOLO		110	Film Orch	4	POLY		046	Film Layers	4	POLY		110	Crash Pad	4	POLY	
047	Acid Line	1	SOLO		111	Sop.Sax mf	2	POLY		047	Bass Pizz	4	POLY		111	Feedback VOX	4	POLY	
048	Auto TB-303	3	SOLO		112	Alto Sax	3	POLY		048	Real Pizz	3	POLY		112	Cascade	1	POLY	
049	Hihat Tekno	2	POLY		113	AltoLead Sax	3	POLY		049	Harp On It	3	POLY		113	Shattered	2	POLY	
050	Velo Tekno 1	3	SOLO		114	Tenor Sax	3	POLY		050	Harp	2	POLY		114	NextFrontier	2	POLY	
051	Raggatronic	4	POLY		115	Baritone Sax	3	POLY		051	JP-8 Str 1	2	POLY		115	Pure Tibet	1	POLY	
052	Blade Racer	4	POLY		116	Take A Tenor	4	POLY		052	JP-8 Str 2	3	POLY		116	Chime Wash	4	POLY	
053	S&H Pad	1	POLY		117	Sax Section	4	POLY		053	E-Motion Pad	4	POLY		117	Night Shade	4	POLY	
054	Syncrosonix	3	POLY		118	Bigband Sax	4	POLY		054	JP-8 Str 3	4	POLY		118	Tortured	4	POLY	
055	Foiled Again	1	POLY		119	Harmonica	2	POLY		055	Vintage Orch	4	POLY		119	Dissimilate	4	POLY	
056	Alive	3	POLY		120	Harmo Blues	2	POLY		056	JUNO Strings	3	POLY		120	Dunes	4	POLY	
057	Velo Tekno 2	2	POLY		121	BluesHarp	1	POLY		057	Gigantalog	4	POLY		121	Ocean Floor	1	POLY	
058	Rezoid	4	POLY		122	Hillbillys	4	POLY		058	PWM Strings	3	POLY		122	Cyber Space	3	POLY	
059	Raverborg	4	POLY		123	French Bags	4	POLY		059	Warmth	2	POLY		123	Biosphere	2	POLY	
060	Blow Hit	4	POLY		124	Majestic Tpt	1	SOLO		060	ORBit Pad	2	POLY		124	Variable Run	4	POLY	
061	Hammer Bell	3	POLY		125	Voluntare	2	POLY		061	Deep Strings	2	POLY		125	Ice Hall	2	POLY	
062	Seq Mallet	2	POLY		126	2Trumpets	2	POLY		062	Pulsify	4	POLY		126	ComputerRoom	4	POLY	
063	Intentions	3	POLY		127	Tpt Sect	4	POLY		063	Pulse Pad	4	POLY		127	Inverted	4	POLY	
064	Pick It	3	POLY		128	Mute TP mod	4	POLY		064	Greek Power	4	POLY		128	Terminate	3	POLY	

GM (GM Group)

No.	Name	Voice	Key Assign	No.	Name	Voice	Key Assign
001	Piano 1	2	POLY	065	Soprano Sax	1	POLY
002	Piano 2	2	POLY	066	Alto Sax	1	POLY
003	Piano 3	2	POLY	067	Tenor Sax	1	POLY
004	Honky-tonk	2	POLY	068	Baritone Sax	2	POLY
005	E.Piano 1	2	POLY	069	Oboe	2	POLY
006	E.Piano 2	4	POLY	070	English Horn	2	POLY
007	Harpsichord	2	POLY	071	Bassoon	2	POLY
008	Clav.	2	POLY	072	Clarinet	1	POLY
009	Celesta	1	POLY	073	Piccolo	1	POLY
010	Glockenspiel	2	POLY	074	Flute	1	POLY
011	Music Box	1	POLY	075	Recorder	2	POLY
012	Vibraphone	1	POLY	076	Pan Flute	2	POLY
013	Marimba	2	POLY	077	Bottle Blow	2	POLY
014	Xylophone	2	POLY	078	Shakuhachi	1	POLY
015	Tubular-bell	2	POLY	079	Whistle	1	POLY
016	Santur	2	POLY	080	Ocarina	2	POLY
017	Organ 1	1	POLY	081	Square Wave	2	POLY
018	Organ 2	1	POLY	082	Saw Wave	2	POLY
019	Organ 3	2	POLY	083	Syn.Calliope	2	POLY
020	Church Org.1	2	POLY	084	Chiffer Lead	2	POLY
021	Reed Organ	1	POLY	085	Charang	3	POLY
022	Accordion Fr	2	POLY	086	Solo Vox	2	POLY
023	Harmonica	1	POLY	087	5th Saw Wave	3	POLY
024	Bandoneon	2	POLY	088	Bass & Lead	2	POLY
025	Nylon-str.Gt	1	POLY	089	Fantasia	3	POLY
026	Steel-str.Gt	1	POLY	090	Warm Pad	2	POLY
027	Jazz Gt.	1	POLY	091	Polysynth	2	POLY
028	Clean Gt.	1	POLY	092	Space Voice	2	POLY
029	Muted Gt.	1	POLY	093	Bowed Glass	3	POLY
030	Overdrive Gt	1	POLY	094	Metal Pad	2	POLY
031	DistortionGt	1	POLY	095	Halo Pad	3	POLY
032	Gt.Harmonics	3	POLY	096	Sweep Pad	2	POLY
033	Acoustic Bs.	3	POLY	097	Ice Rain	2	POLY
034	Fingered Bs.	1	POLY	098	Soundtrack	2	POLY
035	Picked Bs.	1	POLY	099	Crystal	2	POLY
036	Fretless Bs.	1	POLY	100	Atmosphere	2	POLY
037	Slap Bass 1	1	POLY	101	Brightness	3	POLY
038	Slap Bass 2	2	POLY	102	Goblin	2	POLY
039	Synth Bass 1	1	POLY	103	Echo Drops	2	POLY
040	Synth Bass 2	1	POLY	104	Star Theme	2	POLY
041	Violin	1	POLY	105	Sitar	1	POLY
042	Viola	1	POLY	106	Banjo	1	POLY
043	Cello	1	POLY	107	Shamisen	2	POLY
044	Contrabass	1	POLY	108	Koto	1	POLY
045	Tremolo Str	1	POLY	109	Kalimba	1	POLY
046	PizzicatoStr	1	POLY	110	Bag Pipe	3	POLY
047	Harp	2	POLY	111	Fiddle	1	POLY
048	Timpani	1	POLY	112	Shanai	1	POLY
049	Strings	2	POLY	113	Tinkle Bell	4	POLY
050	Slow Strings	1	POLY	114	Agogo	1	POLY
051	Syn.Strings1	2	POLY	115	Steel Drums	1	POLY
052	Syn.Strings2	2	POLY	116	Woodblock	1	POLY
053	Choir Aahs	3	POLY	117	Taiko	4	POLY
054	Voice Oohs	1	POLY	118	Melo. Tom 1	2	POLY
055	SynVox	1	POLY	119	Synth Drum	2	POLY
056	OrchestraHit	2	POLY	120	Reverse Cym.	2	POLY
057	Trumpet	2	POLY	121	Gt.FretNoise	1	POLY
058	Trombone	1	POLY	122	Breath Noise	2	POLY
059	Tuba	2	POLY	123	Seashore	3	POLY
060	MutedTrumpet	1	POLY	124	Bird	4	POLY
061	French Horn	2	POLY	125	Telephone 1	1	POLY
062	Brass 1	2	POLY	126	Helicopter	2	POLY
063	Synth Brass1	1	POLY	127	Applause	4	POLY
064	Synth Brass2	2	POLY	128	Gun Shot	2	POLY

Rhythm set List

Note No.	USER (User Group)		PR-A (Preset A Group)		PR-B (Preset B Group)		PR-C (Preset C Group)		GM (GM Group)	
	001	002	001	002	001	002	001	002	001	002
	HouseDrumSet 1	JazzDrumSet1	PopDrumSet 1	PopDrumSet 2	PowerDrumSet	RaveDrumSet	JazzDrumSet2	OrchDrumSet	GM Drum Set	BrushDrumSet
35	Scratch 1	Hybrid Kick2	Verb Kick	Hybrid Kick1	Verb Kick	808 Kick	Round Kick	Old Kick	Verb Kick	Hybrid Kick2
C2 36	808 SN	Hybrid Kick1	Hybrid Kick1	Round Kick	Round Kick	Round Kick	Old Kick	Round Kick	Hybrid Kick1	Hybrid Kick1
	37	Dry Stick	Side Stick	Side Stick	Dry Stick	Side Stick	Side Stick	Side Stick	Side Stick	Side Stick
38	808 SN	Ballad SN	Natural SN2	Piccolo SN	Piccolo SN	808 SN	Ballad SN	Ballad SN	Ballad SN	Brush Swish
	39	808 Claps	Brush Slap	808 Claps	Hand Claps	808 Claps	808 Claps	Hand Claps	808 Claps	Brush Slap
40	808 SN	Brush Swish	SN Roll	Piccolo SN	Natural SN2	808 SN	SN Roll	SN Roll	Piccolo SN	Brush Roll
41	808 Kick	Verb Tom Lo	Verb Tom Lo	Verb Tom Lo	Verb Tom Lo	808 Kick	Verb Tom Lo	Timpani	Verb Tom Lo	Dry Tom Lo
	42	606 HiHat Cl	Cl HiHat 1	Cl HiHat 1	Cl HiHat 1	606 HiHat Cl	Cl HiHat 2	Timpani	Cl HiHat 1	Cl HiHat 1
43	808 SN	Verb Tom Lo	Verb Tom Lo	Verb Tom Lo	Verb Tom Lo	Tekno Hit	Dry Tom Lo	Timpani	Verb Tom Lo	Dry Tom Lo
	44	606 HiHat Cl	Pedal HiHat	Cl HiHat 2	Cl HiHat 2	Pedal HiHat	606 HiHat Cl	Pedal HiHat	Pedal HiHat	Pedal HiHat
45	808 Kick	Verb Tom Hi	Verb Tom Hi	Verb Tom Hi	Verb Tom Lo	808 Kick	Verb Tom Lo	Timpani	Verb Tom Hi	Dry Tom Hi
	46	606 HiHat Op	Op HiHat	Op HiHat	Op HiHat	606 HiHat Op	Op HiHat	Timpani	Op HiHat	Op HiHat
47	808 SN	Verb Tom Hi	Verb Tom Hi	Verb Tom Hi	Verb Tom Lo	Tekno Hit	Dry Tom Lo	Timpani	Verb Tom Hi	Dry Tom Hi
C3 48	808 Kick	Verb Tom Hi	Verb Tom Hi	Verb Tom Hi	Verb Tom Hi	808 Kick	Verb Tom Hi	Timpani	Verb Tom Hi	Dry Tom Hi
	49	Crash 1	Crash 1	Crash 1	Crash 1	Crash 1	Crash 1	Timpani	Crash 1	Crash 1
50	808 SN	Verb Tom Hi	Verb Tom Hi	Verb Tom Hi	Verb Tom Hi	Tekno Hit	Dry Tom Hi	Timpani	Verb Tom Hi	Dry Tom Hi
	51	Ride 2	Ride 2	Ride 2	Ride 1	Voice Breath	Ride 2	Timpani	Ride 2	Ride 2
52	REV Crash 1	China Cym	China Cym	China Cym	China Cym	MC500 Beep 1	China Cym	Timpani	China Cym	China Cym
53	Ride Bell 1	Ride Bell 1	Ride Bell 1	Ride Bell 1	Ride Bell 1	MC500 Beep 2	Ride Bell 1	Timpani	Ride Bell 1	Ride Bell 1
	54	Tambourine	Tambourine	Tambourine	Tambourine	Tambourine	R8 Click	Tambourine	Tambourine	Tambourine
55	Crash 1	Crash 1	Crash 1	Crash 1	Crash 1	Pizz	Crash 1	Crash 1	Crash 1	Crash 1
	56	Cowbell 1	Cowbell 1	Cowbell 1	Cowbell 1	Cowbell 1	DIGI Bell 1	Cowbell 1	Cowbell 1	Cowbell 1
57	Crash 1	Crash 1	Crash 1	Crash 1	Crash 1	Rattles	Crash 1	Crash 1	Crash 1	Crash 1
	58	Vibraslap	Vibraslap	Cowbell 1	Cowbell 1	Vibraslap	Ride Bell 1	Vibraslap	Ride 1	Vibraslap
59	Ride 2	Ride 2	Ride Bell 1	Ride Bell 1	Ride 1	REV Tamb	Ride 2	Ride 2	Ride 2	Ride 2
C4 60	Bongo Hi	Bongo Hi	Cga Mute Hi	Cga Mute Hi	Bongo Hi	2.2 Vibwave	Bongo Hi	Bongo Hi	Bongo Hi	Cga Mute Hi
	61	Bongo Lo	Bongo Lo	Cga Mute Lo	Cga Mute Lo	Bongo Lo	Low Pink NZ	Bongo Lo	Bongo Lo	Cga Mute Lo
62	Cga Mute Hi	Cga Mute Hi	Cga Slap	Cga Slap	Cga Mute Hi	Kalimba	Cga Mute Hi	Cga Mute Hi	Cga Mute Hi	Cga Slap
	63	Cga Open Hi	Cga Open Hi	Cga Open Hi	Cga Open Hi	Cga Open Hi	Metal Wind	Cga Open Hi	Cga Open Hi	Cga Open Hi
64	Cga Open Lo	Cga Open Lo	Cga Open Lo	Cga Open Lo	Cga Open Lo	Lead Wave	Cga Open Lo	Cga Open Lo	Cga Open Lo	Cga Open Lo
65	Timbale	Timbale	Timbale	Timbale	Timbale	Tin Wave	Timbale	Timbale	Timbale	Timbale
	66	Timbale	Timbale	Timbale	Timbale	Timbale	Agogo	Timbale	Timbale	Timbale
67	Agogo	Agogo	Agogo	Agogo	Agogo	Lite Kick	Agogo	Agogo	Agogo	Agogo
	68	Agogo	Agogo	Agogo	Agogo	Agogo	Agogo	Agogo	Agogo	Agogo
69	Cabasa Cut	Cabasa Up	Cabasa Up	Cabasa Up	Cabasa Up	Lite Kick	Cabasa Up	Cabasa Up	Cabasa Up	Cabasa Up
	70	Maracas	Maracas	Maracas	Maracas	Maracas	Maracas	Maracas	Maracas	Maracas
71	Soft Pad B	Soft Pad B	Soft Pad A	Cabasa Down	Soft Pad A	Gtr Harm A	Soft Pad A	Soft Pad A	Soft Pad A	Soft Pad A
C5 72	Soft Pad A	Soft Pad A	Soft Pad B	Cabasa Cut	Soft Pad B	Gtr Harm A	Brush Swish	Soft Pad B	Soft Pad B	Soft Pad B
	73	Long Guiro	Long Guiro	Long Guiro	808 Kick	Long Guiro	Piano Thump	Long Guiro	Long Guiro	Long Guiro
74	Long Guiro	Long Guiro	Long Guiro	808 SN	Long Guiro	Natural SN1	Long Guiro	Long Guiro	Long Guiro	Long Guiro
	75	Claves	Claves	Claves	DIGI Bell 1	Claves	Hand Claps	Claves	Claves	Claves
76	Wood Block	Wood Block	Wood Block	808 SN	Wood Block	Natural SN1	Wood Block	Wood Block	Wood Block	Wood Block
77	Wood Block	Wood Block	Wood Block	808 Kick	Wood Block	808 SN	Metronome 2	Wood Block	Wood Block	Wood Block
	78	Cuica	Cuica	Cuica	Spectrum	Cuica	PowerChord B	Cuica	Cuica	Cuica
79	Cuica	Cuica	Cuica	808 Kick	Cuica	Hybrid Kick2	Cuica	Cuica	Cuica	Cuica
	80	Open Triangl	Open Triangl	Open Triangl	Spectrum	Open Triangl	PowerChord B	Open Triangl	Open Triangl	Open Triangl
81	Open Triangl	Open Triangl	Open Triangl	808 Kick	Open Triangl	Gt.FretNoise	Open Triangl	Open Triangl	Open Triangl	Open Triangl
	82	Cabasa Cut	Cabasa Cut	Cabasa Cut	Spectrum	Maracas	Banjo B	Cabasa Cut	Cabasa Cut	Cabasa Cut
83	Tambourine	Spectrum	Spectrum	808 Kick	Ice Rain	Slap Bass 1	Spectrum	Spectrum	Spectrum	Spectrum
C6 84	Old Kick	Wind Chimes	Wind Chimes	808 Kick	Wind Chimes	Oboe mf A	Wind Chimes	Wind Chimes	Wind Chimes	Wind Chimes
	85	Scratch 1	Wood Block	Wood Block	Feedbackwave	Claves	Shakuhachi	Wood Block	Wood Block	Wood Block
86	Piccolo SN	Cga Slap	Cga Slap	808 Kick	808 SN	Pizz	Cga Slap	Cga Slap	Cga Slap	Cga Slap
	87	Scratch 3	Dry Tom Lo	Dry Tom Lo	Feedbackwave	Verb Tom Hi	Syn Vox 1	Dry Tom Lo	Dry Tom Lo	Dry Tom Lo
88	White Noise	Lite Kick	Lite Kick	Pop Voice	Piccolo SN	Voice Aahs A	Lite Kick	Applause	Lite Kick	Lite Kick
89	Synth Saw 1	Hybrid Kick2	Hybrid Kick2	Pop Voice	Scratch 3	Voice Oohs2A	Hybrid Kick2	Hybrid Kick2	Hybrid Kick2	Hybrid Kick2
	90	Synth Pulse1	Old Kick	Old Kick	Wind Agogo	Tin Wave	Pop Voice	Old Kick	Cl HiHat 1	Old Kick
91	Back Hit	808 Kick	Pop Voice	Pop Voice	Pop Voice	Spectrum	Male Ooh A	Natural SN2	Round Kick	808 Kick
	92	Tekno Hit	Natural SN1	Wind Agogo	Wind Agogo	REV Steel DR	Voice Breath	Natural SN1	Pedal HiHat	Natural SN1
93	Orch. Hit	Natural SN2	Op HiHat	Op HiHat	REV Tin Wave	Org Vox C	Brush Swish	Natural SN2	Natural SN2	Natural SN2
	94	Philly Hit	SN Roll	Anklungs	Anklungs	REV PiccloSN	Vox Noise	Brush Roll	Op HiHat	808 SN
95	REV Back Hit	Natural SN2	Op HiHat	Op HiHat	REV Crash 1	Vox Noise	Brush Slap	Brush Slap	Brush Slap	Brush Slap
C7 96	MC500 Beep 1	Metronome 2	Metronome 2	Metronome 2	Metronome 2	Applause	Metronome 2	Brush Swish	Brush Swish	Metronome 2
	97	R8 Click	R8 Click	R8 Click	R8 Click	R8 Click	R8 Click	Brush Roll	Brush Roll	R8 Click
98	MC500 Beep 2	Metronome 1	Metronome 1	Metronome 1	Metronome 1	Metronome 2	Metronome 1	SN Roll	SN Roll	Metronome 1

Performance List

USER (User Group)			PR-A (Preset A Group)			PR-B (Preset B Group)		
No.	Name	Key Mode	No.	Name	Key Mode	No.	Name	Key Mode
01	EasternSplit	LAYER	01	House Set	SINGLE	01	Africa	SINGLE
02	Opening Orch	LAYER	02	Analectro	SINGLE	02	World Ethnic	SINGLE
03	Feedback EP	LAYER	03	Anatronic	SINGLE	03	Asian Ethnic	SINGLE
04	Humming Vox	LAYER	04	Tekno Pop 1	SINGLE	04	Asian Band	SINGLE
05	Tekno Loop 1	LAYER	05	Tekno Pop 2	SINGLE	05	60's Set	SINGLE
06	Fr.Horn Sect	LAYER	06	Hard Core	SINGLE	06	Blues Band	SINGLE
07	SpaceCarrier	LAYER	07	Hi Energy	SINGLE	07	Country Band	SINGLE
08	Orchestral	LAYER	08	Pop Dance	SINGLE	08	Folk Set	SINGLE
09	Nebular Vox	LAYER	09	Acid Set	SINGLE	09	Reggae Band	SINGLE
10	Terminator	LAYER	10	Ambient Set	SINGLE	10	FunkWah Band	SINGLE
11	Flying Jazz	LAYER	11	Electro Pop	SINGLE	11	Funkin'Phaze	SINGLE
12	Sweeper	LAYER	12	Pop Set 1	SINGLE	12	Zydeco Band	SINGLE
13	Rave Split	LAYER	13	Pop Set 2	SINGLE	13	New Orleans	SINGLE
14	Multi Sax	LAYER	14	Pop Set 3	SINGLE	14	Dixieland	SINGLE
15	Cosmic Dawn	LAYER	15	Pop Set 4	SINGLE	15	Big Band Set	SINGLE
16	Bass / Lead	LAYER	16	L.A. Ballad	SINGLE	16	Cont.Jazz 1	SINGLE
17	S&H / Pad	LAYER	17	Hip Hop Set	SINGLE	17	Cont.Jazz 2	SINGLE
18	AcPiano+Pad	LAYER	18	Funk Rock	SINGLE	18	Ac.Jazz Set	SINGLE
19	Kicks Attack	LAYER	19	Funk Fusion	SINGLE	19	Gospel Set	SINGLE
20	Step Brass	LAYER	20	Heavy Metal	SINGLE	20	All Strings	SINGLE
21	Drone / Pipe	LAYER	21	Heavy Kids	LAYER	21	All Brass	SINGLE
22	Chime Dreams	LAYER	22	Latin Set	SINGLE	22	All Piano 1	SINGLE
23	Tekno Loop 2	LAYER	23	BrazilianSet	SINGLE	23	All Piano 2	SINGLE
24	Big Band	LAYER	24	New Age 1	SINGLE	24	All Keyboard	SINGLE
25	Labyrinth	LAYER	25	New Age 2	SINGLE	25	All Organ	SINGLE
26	White Hole	LAYER	26	Orchestra	SINGLE	26	All Winds	SINGLE
27	Cyber Sweep	LAYER	27	Concerto	SINGLE	27	All Bells	LAYER
28	Tekno Asia	LAYER	28	Film Score 1	SINGLE	28	Mlt & Perc	SINGLE
29	1080 Fantasy	LAYER	29	Film Score 2	SINGLE	29	All Seq	SINGLE
30	Pop Ballad	LAYER	30	Symphonic	SINGLE	30	All Bass	SINGLE
31	Rhythmatic	LAYER	31	Chamber Set	SINGLE	31	All Pad	SINGLE
32	Power JV	LAYER	32	Baroque Set	SINGLE	32	All FX	SINGLE

Arpeggio style list

Style	Motif	Beat Pattern	Accent Rate	Shuffle Rate
1/4	all	1/4	0-100%	50-90%
1/6	all	1/6	0-100%	50-90%
1/8	all	1/8	0-100%	50-90%
1/12	all	1/12	0-100%	50-90%
1/16	all	1/16 1-3	0-100%	50-90%
1/32	SINGLE UP, SINGLE DOWN, SINGLE UP&DOWN, SINGLE RANDOM, DUAL UP, DUAL DOWN, DUAL UP&DOWN, DUAL RANDOM, NOTE ORDER, GLISSANDO, BASS+UP 1-8, BASS+RANDOM 1-3, TOP+UP 1-6	1/32 1-3	0-100%	50-90%
GLISSANDO	GLISSANDO	1/16 1-3, 1/32 1-3	0-100%	50-90%
SEQUENCE A	all	SEQ-A 1-7	0-100%	50-90%
SEQUENCE B	all	SEQ-B 1-4	0-100%	50-90%
SEQUENCE C	SINGLE UP, SINGLE DOWN, SINGLE UP&DOWN, SINGLE RANDOM, DUAL UP, DUAL DOWN, DUAL UP&DOWN, DUAL RANDOM, NOTE ORDER, GLISSANDO, BASS+UP 1-8, BASS+RANDOM 1-3, TOP+UP 1-6	SEQ-C 1-2	0-100%	50-90%
ECHO	SINGLE UP, SINGLE DOWN, SINGLE UP&DOWN, SINGLE RANDOM, DUAL UP, DUAL DOWN, DUAL UP&DOWN, DUAL RANDOM, NOTE ORDER	ECHO 1-3	0-100%	50-90%
SYNTH BASS	BASS+UP 2	SEQ-A 1, SEQ-C 1	0-100%	50-90%
SLAP BASS A	BASS+UP 5, TOP+UP 5	MUTE 02, 03	0-100%	50-90%
SLAP BASS B	BASS+UP 5, TOP+UP 5	MUTE 02, 03	0-100%	50-90%
WALK BASS	SINGLE UP, SINGLE DOWN, SINGLE UP&DOWN, SINGLE RANDAM, NOTE ORDER, GLISSANDO	WALKBS, REF1	0-100%	50-90%
RHYTHM GTR A	SINGLE UP, SINGLE DOWN, SINGLE UP&DOWN, SINGLE RANDOM, DUAL UP, DUAL DOWN, DUAL UP&DOWN, DUAL RANDOM, NOTE ORDER, BASS+UP 1-8, BASS+RANDOM 1-3, TOP+UP 1-6	MUTE 01,04	0-100%	50-90%
RHYTHM GTR B	CHORD	MUTE 07, 13, 14	0-100%	50-90%
RHYTHM GTR C	CHORD	MUTE 08, 12, 15	0-100%	50-90%
RHYTHM GTR D	CHORD	MUTE 09, 10, 11, 16	0-100%	50-90%
RHYTHM GTR E	SINGLE UP, SINGLE DOWN	STRUM 1-6	0-100%	50-90%
3 FINGER GTR	BASS+UP+TOP	SEQ-A7	0-100%	50-90%
STRUMMING GTR	SINGLE UP, SINGLE DOWN	STRUM 7, 8	0-100%	50-90%
KBD COMPING A	CHORD	MUTE 12, REF2	0-100%	50-90%
KBD COMPING B	BASS+CHORD 4, BASS+CHORD 5	MUTE 05, 06	0-100%	50-90%
KBD COMPING C	BASS+CHORD 2, BASS+UP 2, BASS+RANDOM 2, TOP+UP 2	1/6, 1/12	0-100%	50-90%
KBD COMPING D	BASS+CHORD 2, BASS+UP 2, BASS+RANDOM 2, TOP+UP 2	1/16 1-3	0-100%	50-90%
KBD COMPING E	CHORD	REGGAE	0-100%	50-90%
PERCUSSION	SINGLE UP, SINGLE DOWN, SINGLE UP&DOWN, SINGLE RANDOM, DUAL UP, DUAL DOWN, DUAL UP&DOWN, DUAL RANDOM, NOTE ORDER, BASS+UP 1-8, BASS+RANDOM 1-3, TOP+UP 1-6	PERC1-4	0-100%	50-90%
HARP	SINGLE UP, SINGLE DOWN, SINGLE UP&DOWN, GLISSANDO	HARP	0-100%	50-90%
SHAMISEN	TOP+UP 4-6	SEQ-A 2	0-100%	50-90%
BOUND BALL	SINGLE UP, SINGLE DOWN, SINGLE UP&DOWN, SINGLE RANDOM, DUAL UP, DUAL DOWN, DUAL UP&DOWN, DUAL RANDOM, NOTE ORDER, GLISSANDO	BOUND	0-100%	50-90%
RANDOM	SINGLE RANDOM, DUAL RANDOM, BASS+RANDOM 1-3	1/4 -1/32 3, RANDOM	0-100%	50-90%
LIMITLESS	all	all	0-100%	50-90%

all: there is no restriction on the value which can be set

MIDI implementation

Model: XP-60/XP-80 (Music Workstation)

Version 1.00

Date: Feb. 1 1998

1. Data reception (sound source section)

Channel voice messages

Note Off

<u>status</u>	<u>2nd byte</u>	<u>3rd byte</u>
8nH	kkH	vvH
9nH	kkH	00H
n=MIDI channel number	: 0H - FH (ch.1 - ch.16)	
kk=note number	: 00H - 7FH (0 - 127)	
vv=Note Off velocity	: 00H - 7FH (0 - 127)	

* Not received in Performance mode when the Rx Switch parameter (PERFORM/MIDI/Part MIDI) is OFF.

* Not received by the Rhythm Part (Part 10) when the Envelope Mode parameter (RHYTHM/Key Ctl/Control Param) is NO-SUS.

Note On

<u>status</u>	<u>2nd byte</u>	<u>3rd byte</u>
9nH	kkH	vvH
n=MIDI channel number	: 0H - FH (ch.1 - ch.16)	
kk=note number	: 00H - 7FH (0 - 127)	
vv=Note On velocity	: 01H - 7FH (1 - 127)	

* Not received in Performance mode when the Rx Switch parameter (PERFORM/MIDI/Part MIDI) is OFF.

Polyphonic Aftertouch

<u>status</u>	<u>2nd byte</u>	<u>3rd byte</u>
AnH	kkH	vvH
n=MIDI channel number	: 0H - FH (ch.1 - ch.16)	
kk=note number	: 00H - 7FH (0 - 127)	
vv=Aftertouch	: 00H - 7FH (0 - 127)	

* Not received when the Aftertouch parameter (SYSTEM/Control/Control Source) is POLY or CH&POLY.

* Not received in Performance mode when the Rx Switch parameter (PERFORM/MIDI/Part MIDI) is OFF.

* Not received in GM mode.

Control Change

* If the corresponding Controller number is selected for the <Ctrl 2> or <Ctrl 3> control source parameter (PATCH/Common/Common Control), the corresponding effect will occur.

* If a Controller number that corresponds to the Sys-Ctrl1 parameter or Sys-Ctrl 2 parameter (SYSTEM/Control/Control Assign) is selected, the specified effect will apply if <Ctrl 2> or <Ctrl 3> control source parameter (PATCH/Common/Common Control) is set to SYS-CTRL1 or SYS-CTRL2.

* Not received in Performance mode when the Rx Switch parameter (PERFORM/MIDI/Part MIDI) or the Control Change Receive Switch is OFF.

Bank Select (Controller number 0,32)

<u>status</u>	<u>2nd byte</u>	<u>3rd byte</u>
BnH	00H	mmH
BnH	20H	llH
n=MIDI channel number	: 0H - FH (ch.1 - ch.16)	
mm,ll=Bank number	: 00 00H - 7F 7FH (bank.1 - bank.16384)	

* Not received when the Rx Program Change or Rx Bank Select parameter (SYSTEM/MIDI/MIDI Param 2) is OFF.

* Not received in GM mode.

* The Patches corresponding to each Bank Select are as follows.

Bank Select	Program No	Group	Patch No.
MSB LSB			
80	0	0 - 127	User
81	0	0 - 127	PR-A
81	1	0 - 127	PR-B
81	2	0 - 127	PR-C
81	3	0 - 127	GM
84	0	0 - 127	XP-A
84	1	0 - 127	XP-A
84	2	0 - 127	XP-B
84	3	0 - 127	XP-B
84	4	0 - 127	XP-C
84	5	0 - 127	XP-C
84	6	0 - 127	XP-D
84	7	0 - 127	XP-D

* The Performance corresponding to each Bank Select are as follows.

Bank Select	Program No	Group	Performance No.
MSB LSB			
80	0	0 - 31	User
81	0	0 - 31	PR-A
81	1	0 - 31	PR-B

* The Rhythm set corresponding to each Bank Select are as follows.

Bank Select	Program No	Group	Rhythm set No.
MSB LSB			
80	0	0 - 1	User
81	0	0 - 1	PR-A
81	1	0 - 1	PR-B
81	2	0 - 1	PR-C
81	3	0 - 1	GM
84	0	0 - 127	XP-A
84	1	0 - 127	XP-A
84	2	0 - 127	XP-B
84	3	0 - 127	XP-B
84	4	0 - 127	XP-C
84	5	0 - 127	XP-C
84	6	0 - 127	XP-D
84	7	0 - 127	XP-D

Modulation (Controller number 1)

<u>status</u>	<u>2nd byte</u>	<u>3rd byte</u>
BnH	01H	vvH
n=MIDI channel number	: 0H - FH (ch.1 - ch.16)	
vv=Modulation depth	: 00H - 7FH (0 - 127)	

Breath type (Controller number 2)

<u>status</u>	<u>2nd byte</u>	<u>3rd byte</u>
BnH	02H	vvH
n=MIDI channel number	: 0H - FH (ch.1 - ch.16)	
vv=control value	: 00H - 7FH (0 - 127)	

Foot type (Controller number 4)

<u>status</u>	<u>2nd byte</u>	<u>3rd byte</u>
BnH	04H	vvH
n=MIDI channel number	: 0H - FH (ch.1 - ch.16)	
vv=control value	: 00H - 7FH (0 - 127)	

Portamento Time (Controller number 5)

<u>status</u>	<u>2nd byte</u>	<u>3rd byte</u>
BnH	05H	vvH
n=MIDI channel number	: 0H - FH (ch.1 - ch.16)	
vv=Portamento Time	: 00H - 7FH (0 - 127)	

* The Time parameter (PATCH/Common/Common Control) will change.

Data Entry (Controller number 6,38)

<u>status</u>	<u>2nd byte</u>	<u>3rd byte</u>
BnH	06H	mmH
BnH	26H	llH
n=MIDI channel number	: 0H - FH (ch.1 - ch.16)	
mm,ll= the value of the parameter specified by RPN/NRPN		
mm=MSB, ll=LSB		

Volume (Controller number 7)

<u>status</u>	<u>2nd byte</u>	<u>3rd byte</u>
BnH	07H	vvH
n=MIDI channel number	: 0H - FH (ch.1 - ch.16)	
vv=Volume	: 00H - 7FH (0 - 127)	

Balance (Controller number 8)

<u>status</u>	<u>2nd byte</u>	<u>3rd byte</u>
BnH	08H	vvH
n=MIDI channel number	: 0H - FH (ch.1 - ch.16)	
vv=Volume	: 00H - 7FH (0 - 127)	

Panpot (Controller number 10)

<u>status</u>	<u>2nd byte</u>	<u>3rd byte</u>
BnH	0AH	vvH
n=MIDI channel number	: 0H - FH (ch.1 - ch.16)	
vv=Panpot	: 00H - 40H - 7FH (left - center - right)	

* Adjust the stereo location over 128 steps, where 0 is far left, 64 is center, and 127 is far right. However this is not received when the Pan parameter (PATCH/LFO&Ctl/Control Switch) is OFF.

○ Expression (Controller number 11)

status	2nd byte	3rd byte
BnH	0BH	vvH
n=MIDI channel number	: 0H - FH (ch.1 - ch.16)	
vv=Expression	: 00H - 7FH (0 - 127)	

* If the Volume parameter (SYSTEM/Control/Control Source) is set to VOL&EXP, the volume of the Part corresponding to the MIDI channel of the received message will be adjusted. However this is not received if the Volume parameter (PATCH/LFO&Cti/Control Switch) is OFF.

* In GM mode, the volume can always be controlled.

○ Hold 1 (Controller number 64)

status	2nd byte	3rd byte
BnH	40H	vvH
n=MIDI channel number	: 0H - FH (ch.1 - ch.16)	
vv=control value	: 00H - 7FH (0 - 127) 0-63=OFF, 64-127=ON	

* Not received when the Hold-1 parameter (PATCH/LFO&Cti/Control Switch) is OFF.

○ Portamento (Controller number 65)

status	2nd byte	3rd byte
BnH	41H	vvH
n=MIDI channel number	: 0H - FH (ch.1 - ch.16)	
vv=control value	: 00H - 7FH (0 - 127) 0-63=OFF, 64-127=ON	

* The Switch parameter (PATCH/Common/Common Control) will change.

○ Sostenuto (Controller number 66)

status	2nd byte	3rd byte
BnH	42H	vvH
n=MIDI channel number	: 0H - FH (ch.1 - ch.16)	
vv=control value	: 00H - 7FH (0 - 127) 0-63=OFF, 64-127=ON	

○ Soft (Controller number 67)

status	2nd byte	3rd byte
BnH	43H	vvH
n=MIDI channel number	: 0H - FH (ch.1 - ch.16)	
vv=control value	: 00H - 7FH (0 - 127) 0-63=OFF, 64-127=ON	

○ Hold 2 (Controller number 69)

status	2nd byte	3rd byte
BnH	45H	vvH
n=MIDI channel number	: 0H - FH (ch.1 - ch.16)	
vv=control value	: 00H - 7FH (0 - 127)	

○ Sound Controller 2 (Controller number 71)

status	2nd byte	3rd byte
BnH	47H	kkH
n=MIDI channel number	: 0H - FH (ch.1 - ch.16)	
vv=control value	: 00H - 40H - 7FH (-128 - 0 - +126)	

* The Resonance parameter (PATCH/TVF/TVF Param) will change relatively.

○ Sound Controller 3 (Controller number 72)

status	2nd byte	3rd byte
BnH	48H	kkH
n=MIDI channel number	: 0H - FH (ch.1 - ch.16)	
vv=control value	: 00H - 40H - 7FH (-128 - 0 - +126)	

* The Time 2—4 parameter (PATCH/TVF/TVF Envelope) , The Time 2—4 parameter (PATCH/TVA/TVA Envelope)will change relatively.

○ Sound Controller 4 (Controller number 73)

status	2nd byte	3rd byte
BnH	49H	kkH
n=MIDI channel number	: 0H - FH (ch.1 - ch.16)	
vv=control value	: 00H - 40H - 7FH (-128 - 0 - +126)	

* The Time 1 parameter (PATCH/TVF/TVF Envelope) , The Time 1 parameter (PATCH/TVA/TVA Envelope)will change relatively.

○ Sound Controller 5 (Controller number 74)

status	2nd byte	3rd byte
BnH	4AH	kkH
n=MIDI channel number	: 0H - FH (ch.1 - ch.16)	
vv=control value	: 00H - 40H - 7FH (-64 - 0 - +63)	

* The Cutoff Frequency parameter (PATCH /TVF/TVF Param) will change relatively.

○ General Purpose Controller 5 (Controller number 80)

status	2nd byte	3rd byte
BnH	50H	kkH
n=MIDI channel number	: 0H - FH (ch.1 - ch.16)	
vv=control value	: 00H - 40H - 7FH (-128 - 0 - +126)	

* The Level 1 — 3 parameter (PATCH/TVA/TVA Param) of Tone 1 will change relatively.

○ General Purpose Controller 6 (Controller number 81)

status	2nd byte	3rd byte
BnH	51H	kkH
n=MIDI channel number	: 0H - FH (ch.1 - ch.16)	
vv=control value	: 00H - 40H - 7FH (-128 - 0 - +126)	

* The Level 1 — 3 parameter (PATCH/TVA/TVA Param) of Tone 2 will change relatively.

○ General Purpose Controller 7 (Controller number 82)

status	2nd byte	3rd byte
BnH	52H	kkH
n=MIDI channel number	: 0H - FH (ch.1 - ch.16)	
vv=control value	: 00H - 40H - 7FH (-128 - 0 - +126)	

* The Level 1 — 3 parameter (PATCH/TVA/TVA Param) of Tone 3 will change relatively.

○ General Purpose Controller 8 (Controller number 83)

status	2nd byte	3rd byte
BnH	53H	kkH
n=MIDI channel number	: 0H - FH (ch.1 - ch.16)	
vv=control value	: 00H - 40H - 7FH (-128 - 0 - +126)	

* The Level 1 — 3 parameter (PATCH/TVA/TVA Param) of Tone 4 will change relatively.

○ Portamento Control (Controller number 84)

status	2nd byte	3rd byte
BnH	54H	kkH
n=MIDI channel number	: 0H - FH (ch.1 - ch.16)	
kk=source note number	: 00H - 7FH (0 - 127)	

* A Note On message received immediately after a Portamento control will be sounded with the pitch changing smoothly from the source note number. If a voice is already sounding at the same note number as the source note number, that voice will change pitch to the pitch of the newly received Note On, and continue sounding (i.e., will be played legato).

* The speed of the pitch change caused by Portamento is determined by the Time parameter (PATCH/Common/Common Control) value.

○ Effect 1 (Reverb Send Level) (Controller number 91)

status	2nd byte	3rd byte
BnH	5BH	vvH
n=MIDI channel number	: 0H - FH (ch.1 - ch.16)	
vv=Reverb Send Level	: 00H - 7FH (0 - 127)	

* Not received in Patch mode.

○ Effect 3 (Chorus Send Level) (Controller number 93)

status	2nd byte	3rd byte
BnH	5DH	vvH
n=MIDI channel number	: 0H - FH (ch.1 - ch.16)	
vv=Chorus Send Level	: 00H - 7FH (0 - 127)	

* Not received in Patch mode.

○ RPN MSB/LSB (Controller number 100,101)

status 2nd byte 3rd byte
 BnH 65H mmH
 BnH 64H llH
 n=MIDI channel number : 0H - FH (ch.1 - ch.16)
 mm=MSB of the parameter number specified by RPN
 ll=LSB of the parameter number specified by RPN

<<< RPN >>>

Control Changes include RPN (Registered Parameter Numbers), which are extended parameters whose function is defined in the MIDI specification. When using RPNs, first the RPN (Controller numbers 100 and 101; they can be sent in any order) is transmitted to specify the parameter you wish to control. Then, Data Entry messages (Controller numbers 6 and 38) are used to set the value of the specified parameter. Once a RPN parameter has been specified, all further Data Entry messages on that channel are considered to apply to that specified parameter. In order to prevent accidents, when the desired setting has been made for the parameter, it is recommended that RPN be set to Null.

This device receives the following RPNs.

RPN	Data entry	Notes
MSB LSB	MSB LSB	
00H 00H	mmH —	Pitch Bend Sensitivity mm : 00H - 0CH (0 - 12 semitones) ll : ignored (processed as 00H) Up to 1 octave can be specified in semitone steps. *The Bend Range up parameter, Bend Range Down parameter (PATCH/Common/Common Control) will also be changed. *Not received by the Rhythm Part (Part 10).
00H 01H	mmH llH	Master Fine Tuning mm, ll : 20 00H - 40 00H - 60 00H (-8192 *50 / 8192 - 0 - +8192 * 50 / 8192 cent) *In Patch mode, the Master Tune parameter (SYSTEM/Tune/Tune) will change. *In Performance mode, the Fine Tune parameter of each Part (PERFORM/Part/Part Param) will change. When received on the Control channel, the Master Tune parameter (SYSTEM/Tune/Tune) will change.
00H 02H	mmH —	Master Coarse Tuning mm : 10H - 40H - 70H (-48 - 0 - +48 semitones) ll : ignored (processed as 00H) * Not received in Patch mode. * In Performance mode, the Coarse parameter of each Part (PERFORM:PART:PART SETTING) will change.
7FH 7FH	— —	RPN null RPN and NRPN will be set as "unspecified". Once this setting has been made, subsequent Data Entry messages will be ignored. (It is not necessary to transmit Data Entry for RPN Null settings. Parameter values that were previously set will not change. mm, ll : ignored

● Program Change

status 2nd byte
 CnH ppH
 n=MIDI channel number : 0H - FH (ch.1 - ch.16)
 pp=Program number : 00H - 7FH (prog.1 - prog.128)

- * Not received when the Rx Program Change parameter (SYSTEM/MIDI/MIDI Param 2) is OFF.
- * When received on the Control channel, the Performance will change.
- * Not received in Performance mode when the Rx Switch parameter (PERFORM/MIDI/Part MIDI) is OFF.

● Channel Aftertouch

status 2nd byte
 DnH vvH
 n=MIDI channel number : 0H - FH (ch.1 - ch.16)
 vv=Channel Aftertouch : 00H - 7FH (0 - 127)

- * Not received in Performance mode when the Rx Switch parameter (PERFORM/MIDI/Part MIDI) is OFF.

● Pitch Bend Change

status 2nd byte 3rd byte
 EnH llH mmH
 n=MIDI channel number : 0H - FH (ch.1 - ch.16)
 mm,ll=Pitch Bend value : 00 00H - 40 00H - 7F 7FH (-8192 - 0 - +8191)

- * Not received in Performance mode when the Rx Switch parameter (PERFORM/MIDI/Part MIDI) is OFF.

■ Channel Mode messages

● All Sound Off (Controller number 120)

status 2nd byte 3rd byte
 BnH 78H 00H
 n=MIDI channel : 0H - FH (ch.1 - ch.16)

- * When this message is received, all notes currently sounding on the corresponding channel will be turned off.
- * Not received in Performance mode when the Rx Switch parameter (PERFORM/MIDI/Part MIDI) is OFF.

● Reset All Controllers (Controller number 121)

status 2nd byte 3rd byte
 BnH 79H 00H
 n=MIDI channel number : 0H - FH (ch.1 - ch.16)

- * Not received in Performance mode when the Rx Switch parameter (PERFORM/MIDI/Part MIDI) is OFF.
- * When this message is received, the following controllers will be set to their reset values.

Controller	Reset value
Pitch Bend Change	±0 (center)
Polyphonic Key Pressure	0 (off)
Channel Pressure	0 (off)
Modulation	0 (off)
Breath type	0 (minimum)
Expression	127 (maximum)
	However the controller will be at minimum.
Hold 1	0 (off)
Sostenuto	0 (off)
Soft	0 (off)
Hold 2	0 (off)
RPN	Unset. Previously set data will not change.
NRPN	Unset. Previously set data will not change.
System General purpose controller 1	0 (minimum)
System General purpose controller 2	0 (minimum)

● All Note Off (Controller number 123)

status 2nd byte 3rd byte
 BnH 7BH 00H
 n=MIDI channel number : 0H - FH (ch.1 - ch.16)

- * When All Note Off is received, all currently sounding notes of the corresponding channel will be turned off. However if Hold 1 or Sostenuto are on, the sound will be held until these are turned off.
- * Not received in Performance mode if Rx Switch parameter (PERFORM/MIDI/Part MIDI) is OFF.

● Omni Off (Controller number 124)

status 2nd byte 3rd byte
 BnH 7CH 00H
 n=MIDI channel number : 0H - FH (ch.1 - ch.16)

- * The same processing as when All Note Off is received will be done.
- * Not received in Performance mode if Rx Switch parameter (PERFORM/MIDI/Part MIDI) is OFF.

● **Omni On (Controller number 125)**

status 2nd byte 3rd byte
 BnH 7DH 00H
 n=MIDI channel number : 0H - FH (ch.1 - ch.16)

- * The same processing as when All Note Off is received will be done. The instrument will not be set to OMNI ON.
- * Not received in Performance mode if Rx Switch parameter (PERFORM/MIDI/Part MIDI) is OFF.

● **Mono (Controller number 126)**

status 2nd byte 3rd byte
 BnH 7EH mmH
 n=MIDI channel number : 0H - FH (ch.1 - ch.16)
 mm=Mono number : 00H - 10H (0 - 16)

- * The same processing as when All Note Off is received will be done, and the Key Assign parameter (PATCH/Common/Common Control) will be set to SOLO.
- * Not received in Performance mode if Rx Switch parameter (PERFORM/MIDI/Part MIDI) is OFF.

● **Poly (Controller number 127)**

status 2nd byte 3rd byte
 BnH 7FH 00H
 n=MIDI channel number : 0H - FH (ch.1 - ch.16)

- * The same processing as when All Note Off is received will be done, and the Key Assign parameter (PATCH/Common/Common Control) will be set to POLY.
- * Not received in Performance mode if Rx Switch parameter (PERFORM/MIDI/Part MIDI) is OFF.

■ **System Realtime messages**

● **Active Sensing**

status
 FEH

- * When an Active Sensing message is received, the unit will begin monitoring the interval at which MIDI messages are received. During monitoring, if more than 420 ms passes without a message being received, the same processing will be done as when All Sound Off, All Note Off, and Reset All Controllers messages are received. Then monitoring will be halted.

■ **System Exclusive messages**

status data byte status
 F0H iiH, ddH,, eeH F7H

F0H : System Exclusive message status
 ii = ID number : This is the ID number (manufacturer ID) that specifies the manufacturer whose exclusive message this is. Roland's manufacturer ID is 41H. ID numbers 7EH and 7FH are defined in an expansion of the MIDI standard as Universal Non-realtime messages (7EH) and Universal Realtime Messages (7FH).
 dd,.... ee = data : 00H - 7FH (0 - 127)
 F7H : EOX (End Of Exclusive)

Of the System Exclusive messages received by this device, the data of messages related to Mode settings and the Data Request (RQ1) messages will be set automatically.

● **System Exclusive messages related to Mode settings**

These messages are used to initialize the instrument to GM mode, or to switch from one mode to another mode.
 "GM System On" and "GM System Off" use Universal Non-realtime message format.

○ **GM System On**

"GM System On" is a command message that resets the internal settings of the instrument to the GM initial state (General MIDI System - Level 1). A GM instrument that receives this message will automatically enter a state in which it can correctly perform a GM score.

status data byte status
 F0H 7EH, 7FH, 09H, 01H F7H

Byte Remarks
 F0H Exclusive status
 7EH ID number (Universal Non-realtime message)
 7FH device ID (Broadcast)
 09H sub ID#1 (General MIDI Message)
 01H sub ID#2 (General MIDI On)
 F7H EOX (End Of Exclusive)

- * Not received when the Rx.GM-ON Message parameter (SYSTEM/MIDI/MIDI Param 1) is OFF.

○ **GM System Off**

When this messages is received, this instrument will return to the performance mode.

status data byte status
 F0H 7EH, 7FH, 09H, 02H F7H

Byte Remarks
 F0H Exclusive status
 7EH ID number (Universal Non-realtime message)
 7FH device ID (Broadcast)
 09H sub ID#1 (General MIDI Message)
 02H sub ID#2 (General MIDI Off)
 F7H EOX (End Of Exclusive)

- * Not received when the Rx.GM-ON Message parameter (SYSTEM/MIDI/MIDI Param 1) is OFF.

● **Data transmission**

This instrument can use exclusive messages to exchange many varieties of internal settings with other devices.
 The model ID of the exclusive messages used by this instrument is 6AH.

○ **Data Request 1 RQ1**

This message requests the other device to transmit data. The address and size indicate the type and amount of data that is requested.
 When a Data Request message is received, if the device is in a state in which it is able to transmit data, and if the address and size are appropriate, the requested data is transmitted as a Data Set 1 (DT1) message. If the conditions are not met, nothing is transmitted.

status data byte status
 F0H 41H, dev, 6AH, 11H, aaH, bbH, ccH, ddH, ssH, ttH, uuH, vvH, sum F7H

Byte Remarks
 F0H Exclusive status
 41H ID number (Roland)
 dev device ID (dev : 10H - 1FH)
 6AH model ID (XP-60/XP-80)
 11H command ID (RQ1)
 aaH address MSB
 bbH address
 ccH address
 ddH address LSB
 ssH size MSB
 ttH size
 uuH size
 vvH size LSB
 sum checksum
 F7H EOX (End Of Exclusive)

- * The size of data that can be transmitted at one time is fixed for each type of data. and data requests must be made with a fixed starting address and size. Refer to the address and size given in "5. Parameter address map." (p.221)
- * For the checksum, refer to page 227.
- * This message is not received if the Rx.Sys.Excl parameter (SYSTEM/MIDI/MIDI Param 1) is OFF.
- * This message is not received in GM mode.

○ **Data Set 1 DT1**

This message transmits the actual data, and is used when you wish to set the data of the receiving device.

status data byte status
 F0H 41H, dev, 6AH, 12H, aaH, bbH, ccH, ddH, eeH, ... ffH, sum F7H

Byte	Remarks
F0H	Exclusive status
41H	ID number (Roland)
dev	device ID (dev : 10H - 1FH)
6AH	model ID (XP-60/XP-80)
12H	command ID (DT1)
aaH	address MSB
bbH	address
ccH	address
ddH	address LSB
eeH	data : The actual data to be transmitted. Multi-byte data is transmitted in the order of the address.
:	:
ffH	data
sum	checksum
F7H	EOX (End Of Exclusive)

- * The amount of data that is transmitted at one time is fixed for the type of data, and only data of the fixed starting address and size will be transmitted. Refer to the address and size given in "5. Parameter address map" (p.221).
- * Data whose size is greater than 128 bytes should be divided into packets of 128 bytes or less and transmitted. Successive "Data Set 1" messages should have at least 20 ms of time interval between them.
- * For the checksum please refer to page 227.
- * This message is not received if Rx.Sys.Excl parameter (SYSTEM/MIDI/ MIDI Param 1) is OFF.
- * This message is not received in GM mode.

This device is able to receive GS Exclusive messages only for Scale Tune settings.

○ Data Set 1 DT1

This message transmits the actual data, and is used when you wish to set the data of the receiving device.

status	data byte	status
F0H	41H, dev, 42H, 12H, aaH, bbH, ccH, ddH, ... eeH, sum	F7H

Byte	Remarks
F0H	Exclusive status
41H	ID number (Roland)
dev	device ID (dev : 10H - 1FH)
42H	model ID (GS)
12H	command ID (DT1)
aaH	address MSB
bbH	address middle byte
ccH	address LSB
ddH	data : The actual data to be transmitted. Multi-byte data is transmitted in the address order.
:	:
eeH	data
sum	checksum
F7H	EOX (End Of Exclusive)

- * This message is not received when the Rx.Exc parameter (SYSTEM:MIDI: SYS-EXC MIDI) is OFF.
- * This message is not received in GM mode.

2. Data transmission (sound source section)

■ Channel Voice messages

● Note Off

status	2nd byte	3rd byte
8nH	kkH	vvH
9nH	kkH	00H
n=MIDI channel	: 0H - FH (ch.1 - ch.16)	
kk=Note Number	: 00H - 7FH (0 - 127)	
vv=Note Off Velocity	: 00H - 7FH (0 - 127)	

● Note On

status	2nd byte	3rd byte
9nH	kkH	vvH
n=MIDI channel number	: 0H - FH (ch.1 - ch.16)	
kk=note number	: 00H - 7FH (0 - 127)	
vv=Note On velocity	: 01H - 7FH (1 - 127)	

● Control Change

By selecting a controller number that corresponds to the setting of the Assign parameter (SYSTEM/Control/Control Assign) of C1 Slider or C2 Slider /Assign parameter (SYSTEM/Control/Pedal Control) of Pedal 1 — 4, you can transmit any desired control change.

○ Bank Select (Controller number 0,32)

status	2nd byte	3rd byte
BnH	00H	mmH
BnH	20H	llH
n=MIDI channel number	: 0H - FH (ch.1 - ch.16)	
mm,ll=Bank number	: 00 00H - 7F 7FH (bank.1 - bank.16384)	

* This message is not transmitted if Tx Program Change parameter (SYSTEM/MIDI/MIDI Param 2) or Tx Bank Select parameter (SYSTEM/MIDI/ MIDI Param 2) is OFF.

* For the Bank Select that corresponds to each Patch, refer to section 1.

* This message is not transmitted in GM mode

○ Modulation (Controller number 1)

status	2nd byte	3rd byte
BnH	01H	vvH
n=MIDI channel number	: 0H - FH (ch.1 - ch.16)	
vv=Modulation Depth	: 00H - 7FH (0 - 127)	

○ Breath type (Controller number 2)

status	2nd byte	3rd byte
BnH	02H	vvH
n=MIDI channel number	: 0H - FH (ch.1 - ch.16)	
vv=control value	: 00H - 7FH (0 - 127)	

○ Foot type (Controller number 4)

status	2nd byte	3rd byte
BnH	04H	vvH
n=MIDI channel number	: 0H - FH (ch.1 - ch.16)	
vv=control value	: 00H - 7FH (0 - 127)	

○ Portamento Time (Controller number 5)

status	2nd byte	3rd byte
BnH	05H	vvH
n=MIDI channel number	: 0H - FH (ch.1 - ch.16)	
vv=Portamento Time	: 00H - 7FH (0 - 127)	

○ Volume (Controller number 7)

status	2nd byte	3rd byte
BnH	07H	vvH
n=MIDI channel number	: 0H - FH (ch.1 - ch.16)	
vv=Volume	: 00H - 7FH (0 - 127)	

○ Panpot (Controller number 10)

status	2nd byte	3rd byte
BnH	0AH	vvH
n=MIDI channel number	: 0H - FH (ch.1 - ch.16)	
vv=panpot	: 00H - 40H - 7FH (left - center - right)	

○ Expression (Controller number 11)

status	2nd byte	3rd byte
BnH	0BH	vvH
n=MIDI channel number	: 0H - FH (ch.1 - ch.16)	
vv=Expression	: 00H - 7FH (0 - 127)	

○ Hold 1 (Controller number 64)

status	2nd byte	3rd byte
BnH	40H	vvH
n=MIDI channel number	: 0H - FH (ch.1 - ch.16)	
vv=control value	: 00H - 7FH (0 - 127) 0-63=OFF, 64-127=ON	

○ Portamento (Controller number 65)

status	2nd byte	3rd byte
BnH	41H	vvH
n=MIDI channel number	: 0H - FH (ch.1 - ch.16)	
vv=control value	: 00H - 7FH (0 - 127) 0-63=OFF, 64-127=ON	

○ Sostenuto (Controller number 66)

status	2nd byte	3rd byte
BnH	42H	vvH
n=MIDI channel number	: 0H - FH (ch.1 - ch.16)	
vv=control value	: 00H - 7FH (0 - 127) 0-63=OFF, 64-127=ON	

○ Soft (Controller number 67)

status	2nd byte	3rd byte
BnH	43H	vvH
n=MIDI channel number	: 0H - FH (ch.1 - ch.16)	
vv=control value	: 00H - 7FH (0 - 127) 0-63=OFF, 64-127=ON	

● Control Change

status	2nd byte	3rd byte
BnH	kkH	vvH
n=MIDI channel number	: 0H - FH (ch.1 - ch.16)	
kk=control number	: 00H - 78H (0 - 120)	
vv=value	: 00H - 7FH (0 - 127)	

* This message is not received if the Ctrl Change parameter (Rec Select window) is OFF.

● Program Change

status	2nd byte
CnH	ppH
n=MIDI channel number	: 0H - FH (ch.1 - ch.16)
pp=Program number	: 00H - 7FH (prog.1 - prog.128)

* This message is not received if the Prog Change parameter (Rec Select window) is OFF.

● Channel Aftertouch

status	2nd byte
DnH	vvH
n=MIDI channel number	: 0H - FH (ch.1 - ch.16)
vv=Channel Aftertouch	: 00H - 7FH (0 - 127)

* This message is not received if the Channel Aft parameter (Rec Select window) is OFF.

● Pitch Bend Change

status	2nd byte	3rd byte
EnH	llH	mmH
n=MIDI channel number	: 0H - FH (ch.1 - ch.16)	
mm,ll=Pitch Bend value	: 00 00H - 40 00H - 7F 7FH (-8192 - 0 - +8191)	

* This message is not received when the Pitch Bend parameter (Rec Select window) is OFF.

■ Channel Mode messages

● All Sound Off (Controller number 120)

status	2nd byte	3rd byte
BnH	78H	00H
n=MIDI channel number	: 0H - FH (ch.1 - ch.16)	

● Reset All Controllers (Controller number 121)

status	2nd byte	3rd byte
BnH	79H	00H
n=MIDI channel number	: 0H - FH (ch.1 - ch.16)	

● Omni Off (Controller number 124)

status	2nd byte	3rd byte
BnH	7CH	00H
n=MIDI channel number	: 0H - FH (ch.1 - ch.16)	

* The same processing will be done as when an All Note Off message is received.

● Omni On (Controller number 125)

status	2nd byte	3rd byte
BnH	7DH	00H
n=MIDI channel number	: 0H - FH (ch.1 - ch.16)	

* The same processing will be done as when an All Note Off message is received.

● Mono (Controller number 126)

status	2nd byte	3rd byte
BnH	7EH	mmH
n=MIDI channel number	: 0H - FH (ch.1 - ch.16)	
mm=mono number	: 00H - 10H (0 - 16)	

* The same processing will be done as when an All Note Off message is received.

● Poly (Controller number 127)

status	2nd byte	3rd byte
BnH	7FH	00H
n=MIDI channel number	: 0H - FH (ch.1 - ch.16)	

* The same processing will be done as when an All Note Off message is received.

■ System Exclusive messages

status	data byte	status
F0H	iiH, ddH,, eeH	F7H

F0H	: System Exclusive message status
ii = ID number	: This is the ID number (manufacturer ID) that specifies the manufacturer whose exclusive message this is. Roland's manufacturer ID is 41H.ID numbers 7EH and 7FH are defined in an expansion of the MIDI standard as Universal Non-real-time messages (7EH) and Universal Realtime Messages (7FH).
dd,...., ee = data	: 00H - 7FH (0 - 127)
F7H	: EOX (End Of Exclusive)

* These messages are not received if the Sys.Excl parameter (Rec Select window) is OFF.

3.2 Messages not recorded during recording

■ Channel Mode messages

● Local On/Off (Controller number 122)

status	2nd byte	3rd byte
BnH	7AH	00H
n=MIDI channel number	: 0H - FH (ch.1 - ch.16)	
vv=value	: 00H,7FH (Local off, Local on)	

● All Note Off (Controller number 123)

status	2nd byte	3rd byte
BnH	7BH	00H
n=MIDI channel number	: 0H - FH (ch.1 - ch.16)	

* When an All Note Off message is received, all notes of the corresponding channel that are on will be sent Note Off's, and the resulting Note Off messages will be recorded.

3.3 Messages acknowledged for synchronization

■ System Common messages

● Song Position Pointer

status	2nd byte	3rd byte
F2H	mmH	llH
mm,ll=value: 00 00H - 7F 7FH	(0 - 16383)	

● Song Select

status	2nd byte
F3H	ssH
ss=value	: 0 - 7FH (0 - 127)

* This message can be received when the sequencer is stopped. It will not be received while in the Edit display or Microscope display.

■ System Realtime messages

● Timing Clock

status
F8H

* This message will be received if the Sync Mode parameter (SEQUENCER/Setup/SEQ System Setup) is SLAVE.

● Start

status
FAH

* This message will be received if the Sync Mode parameter (SEQUENCER/Setup/SEQ System Setup) is SLAVE or REMOTE.

● Continue

status
FBH

* This message will be received if the Sync Mode parameter (SEQUENCER/Setup/SEQ System Setup) is SLAVE or REMOTE.

● Stop

status
FCH

* This message will be received if the Sync Mode parameter (SEQUENCER/Setup/SEQ System Setup) is SLAVE or REMOTE.

4. Data transmission (Sequencer section)

4.1 Recorded messages are transmitted during playback.

4.2 If the Through parameter (SEQUENCER/Setup/SEQ System Setup) is ON, messages received (except for System Common messages and System Realtime messages) will be transmitted.

4.3 Messages that are generated and transmitted

4.3.1 Messages automatically generated by the system

■ Channel Mode messages

● Omni Off (Controller number 124)

<u>status</u>	<u>2nd byte</u>	<u>3rd byte</u>
BnH	7CH	00H

n=MIDI channel number : 0H - FH (ch.1 - ch.16)

* At start-up, this message is transmitted to all channels.

● Poly (Controller number 127)

<u>status</u>	<u>2nd byte</u>	<u>3rd byte</u>
BnH	7FH	00H

n=MIDI channel number : 0H - FH (ch.1 - ch.16)

* At start-up, this message is transmitted to all channels.

4.3.2 Messages generated and transmitted when the Sync Output switch is ON

■ System Common messages

● Song Position Pointer

<u>status</u>	<u>2nd byte</u>	<u>3rd byte</u>
F2H	mmH	llH

mm,ll=value: 00 00H - 7F 7FH (0 - 16383)

● Song Select

<u>status</u>	<u>2nd byte</u>
F3H	ssH

ss=value : 0 - 7FH (0 - 127)

■ System Realtime messages

● Timing Clock

<u>status</u>
F8H

● Start

<u>status</u>
FAH

● Continue

<u>status</u>
FBH

● Stop

<u>status</u>
FCH

4.3.3 Messages generated and transmitted when the MMC Output switch is ON

● STOP (MCS)

<u>status</u>	<u>data byte</u>	<u>status</u>
F0H	7FH, dev, 06H, 01H	F7H

<u>Byte</u>	<u>Remarks</u>
F0H	Exclusive status
7FH	Universal System Exclusive Realtime Header
7FH	Device ID
06H	MMC Command Message
01H	STOP(MCS)
F7H	EOX (End Of Exclusive)

● DEFERRED PLAY (MCS)

<u>status</u>	<u>data byte</u>	<u>status</u>
F0H	7FH, dev, 06H, 03H	F7H

<u>Byte</u>	<u>Remarks</u>
F0H	Exclusive status
7FH	Universal System Exclusive Realtime Header
7FH	Device ID
06H	MMC Command Message
03H	DEFERRED PLAY(MCS)
F7H	EOX (End Of Exclusive)

● LOCATE (MCP)

FORMAT2 - LOCATE[TARGET]

<u>status</u>	<u>data byte</u>	<u>status</u>
F0H	7FH, dev, 06H, 44H, 06H, 01H, hrH, mnH, scH, frH, ffH	F7H

<u>Byte</u>	<u>Remarks</u>
F0H	Exclusive status
7FH	Universal System Exclusive Realtime Header
7FH	Device ID
06H	MMC Command Message
44H	LOCATE[TARGET]
06H	Byte count
01H	"TARGET" sub-Command
hrH	Standard Time Specification with subframes (type{ff})
mnH	
scH	
frH	
ffH	
F7H	EOX (End Of Exclusive)

5. Parameter address map

1. XP-60/XP-80 (Model ID=6AH)

Note: For addresses marked by a #, the data must be divided into 2 parts for transmission. For example, data with the hexadecimal value ABH would be divided into 0AH and 0BH, and transmitted in that order.

Note: Parameter values enclosed in < > are for the JV-1080, and will be ignored if received by the XP-60/XP-80.

Start Address	Description	
00 00 00 00	System	1-1
01 00 00 00	Temporary Performance	1-2
02 00 00 00	Performance Mode Temporary Patch (part 1)	1-3
02 01 00 00	Performance Mode Temporary Patch (part 2)	
:	:	
02 08 00 00	Performance Mode Temporary Patch (part 9)	
02 09 00 00	Temporary Rhythm Setup	1-4
02 0A 00 00	Performance Mode Temporary Patch (part 11)	1-3
:	:	
02 0F 00 00	Performance Mode Temporary Patch (part 16)	
03 00 00 00	Patch Mode Temporary Patch	1-3
10 00 00 00	User Performance USER:01	1-2
10 01 00 00	User Performance USER:02	
:	:	
10 1F 00 00	User Performance USER:32	
10 40 00 00	User Rhythm Setup USER:1	1-4
10 41 00 00	User Rhythm Setup USER:2	
11 00 00 00	User Patch USER:001	1-3
11 01 00 00	User Patch USER:002	
:	:	
11 7F 00 00	User Patch USER:128	

1-1.System

Offset Address	Description	
00 00	System Common	1-1-1
10 00	Part 1 Scale Tune	1-1-2
11 00	Part 2 Scale Tune	
:	:	
1F 00	Part 16 Scale Tune	
20 00	Patch Mode Scale Tune	1-1-2

1-1-1. System Common

Offset Address	Description		
00 00	0000 00aa	Sound Mode	0 - 2 *1
00 01	0aaa aaaa	Performance Number	0 - 127 *2
00 02	0000 00aa	Patch Group Type	0 - 2 *3
00 03	0aaa aaaa	Patch Group ID	1 - 127
00 04	0000 aaaa	Patch Number	0 - 254 (001 - 255)
00 06	0aaa aaaa	Master Tune	0 - 126 (427.4 - 452.6)
00 07	0000 000a	Scale Tune Switch	0 - 1
00 08	0000 000a	EFX Switch	(OFF,ON)
00 09	0000 000a	Chorus Switch	0 - 1
00 0A	0000 000a	Reverb Switch	(OFF,ON)
00 0B	0000 000a	Patch Remain	0 - 1
00 0C	0000 000a	Clock Source	(OFF,ON)
00 0D	0000 0aaa	TAP Control Source	0 - 1
00 0E	0000 0aaa	Hold Control Source	0 - 4 *5
00 0F	0000 0aaa	Peak Control Source	0 - 4 *5
00 10	0000 000a	Volume Control Source	0 - 1 *6
00 11	0000 00aa	Aftertouch Source	0 - 2 *7
00 12	0aaa aaaa	System Control Source 1	1 - 97 *8
00 13	0aaa aaaa	System Control Source 2	1 - 97 *8
00 14	0000 000a	Receive Program Change	0 - 1 (OFF,ON)
00 15	0000 000a	Receive Bank Select	0 - 1 (OFF,ON)
00 16	0000 000a	Receive Control Change	0 - 1 (<OFF,ON>)
00 17	0000 000a	Receive Modulation	0 - 1 (<OFF,ON>)
00 18	0000 000a	Receive Volume	0 - 1 (<OFF,ON>)
00 19	0000 000a	Receive Hold-1	0 - 1 (<OFF,ON>)
00 1A	0000 000a	Receive Bender	0 - 1 (<OFF,ON>)
00 1B	0000 000a	Receive Aftertouch	0 - 1 (<OFF,ON>)
00 1C	000a aaaa	Control Channel	0 - 16 (1 - 16,OFF)
00 1D	0000 aaaa	Patch Receive Channel	0 - 15 (1 - 16)
00 1E	0000 000a	Rhythm Edit Source	0 - 1 (<OFF,ON>)
00 1F	0000 000a	Preview Sound Mode	0 - 1 (<SINGLE,CHORD>)
00 20	0aaa aaaa	Preview Note Set 1	0 - 127 (<C-1 - G9>)
00 21	0aaa aaaa	Preview Velocity Set 1	0 - 127 (<OFF,1 - 127>)
00 22	0aaa aaaa	Preview Note Set 2	0 - 127 (<C-1 - G9>)
00 23	0aaa aaaa	Preview Velocity Set 2	0 - 127 (<OFF,1 - 127>)
00 24	0aaa aaaa	Preview Note Set 3	0 - 127 (<C-1 - G9>)
00 25	0aaa aaaa	Preview Velocity Set 3	0 - 127 (<OFF,1 - 127>)
00 26	0aaa aaaa	Preview Note Set 4	0 - 127 (<C-1 - G9>)
00 27	0aaa aaaa	Preview Velocity Set 4	0 - 127 (<OFF,1 - 127>)
00 28	0000 000a	Transmit Program Change	0 - 1 (OFF,ON)
00 29	0000 000a	Transmit Bank Select	0 - 1 (OFF,ON)
00 2A	000a aaaa	Patch Transmit Channel	0 - 17 (1 - 16,Rx-Ch,OFF)
00 2B	0000 000a	Transpose Switch	0 - 1 (OFF,ON)
00 2C	0000 aaaa	Transpose Value	0 - 11 (-5 - +6)
00 2D	0000 0aaa	Octave Shift	0 - 6 (-3 - +3)
00 2E	0aaa aaaa	Keyboard Velocity	0 - 127 (REAL,1 - 127)
00 2F	0000 00aa	Keyboard Sens	0 - 2 *9
00 30	0aaa aaaa	Aftertouch Sens	0 - 100
00 31	0aaa aaaa	Pedal1 Assign	1 - 104 *10
00 32	0000 00aa	Pedal1 Output Mode	0 - 3 *11
00 33	0000 000a	Pedal1 Polarity	0 - 1 *12
00 34	0aaa aaaa	Pedal2 Assign	1 - 104 *10
00 35	0000 00aa	Pedal2 Output Mode	0 - 3 *11
00 36	0000 000a	Pedal2 Polarity	0 - 1 *12
00 37	0aaa aaaa	C1 Assign	1 - 97 *13
00 38	0000 00aa	C1 Output Mode	0 - 3 *11
00 39	0aaa aaaa	C2 Assign	1 - 97 *13
00 3A	0000 00aa	C2 Output Mode	0 - 3 *11
00 3B	0000 00aa	Hold Pedal Output Mode	0 - 3 *11
00 3C	0000 000a	Hold Pedal Polarity	0 - 1 *12
00 3D	0000 000a	Bank Select Group1 Switch	0 - 1 (OFF,ON)
00 3E	0aaa aaaa	Bank Select Group1 MSB	0 - 127
00 3F	0aaa aaaa	Bank Select Group1 LSB	0 - 127
00 40	0000 000a	Bank Select Group2 Switch	0 - 1 (OFF,ON)
00 41	0aaa aaaa	Bank Select Group2 MSB	0 - 127
00 42	0aaa aaaa	Bank Select Group2 LSB	0 - 127
00 43	0000 000a	Bank Select Group3 Switch	0 - 1 (OFF,ON)
00 44	0aaa aaaa	Bank Select Group3 MSB	0 - 127
00 45	0aaa aaaa	Bank Select Group3 LSB	0 - 127
00 46	0000 000a	Bank Select Group4 Switch	0 - 1

00 47	0aaa aaaa	Bank Select Group4 MSB	(OFF,ON) 0 - 127
00 48	0aaa aaaa	Bank Select Group4 LSB	0 - 127
00 49	0000 000a	Bank Select Group5 Switch	0 - 1 (OFF,ON)
00 4A	0aaa aaaa	Bank Select Group5 MSB	0 - 127
00 4B	0aaa aaaa	Bank Select Group5 LSB	0 - 127
00 4C	0000 000a	Bank Select Group6 Switch	0 - 1 (OFF,ON)
00 4D	0aaa aaaa	Bank Select Group6 MSB	0 - 127
00 4E	0aaa aaaa	Bank Select Group6 LSB	0 - 127
00 4F	0000 000a	Bank Select Group7 Switch	0 - 1 (OFF,ON)
00 50	0aaa aaaa	Bank Select Group7 MSB	0 - 127
00 51	0aaa aaaa	Bank Select Group7 LSB	0 - 127
00 52	0aaa aaaa	Pedal3 Assign	1 - 104 *10
00 53	0000 00aa	Pedal3 Output Mode	0 - 3 *11
00 54	0000 000a	Pedal3 Polarity	0 - 1 *12
00 55	0aaa aaaa	Pedal4 Assign	1 - 104 *10
00 56	0000 00aa	Pedal4 Output Mode	0 - 3 *11
00 57	0000 000a	Pedal4 Polarity	0 - 1 *12
00 58	00aa aaaa	Arpeggio Style	0 - 32 (1 - 33)
00 59	00aa aaaa	Arpeggio Motif	0 - 33 (1 - 34)
00 5A	00aa aaaa	Arpeggio Beat Pattern	0 - 60 (1 - 61)
00 5B	0aaa aaaa	Arpeggio Accent Rate	0 - 100
00 5C	0aaa aaaa	Arpeggio Shuffile Rate	50 - 90
00 5D	0aaa aaaa	Arpeggio Keyboard Velocity	0 - 127 (REAL,1 - 127)
00 5E	0000 0aaa	Arpeggio Octave Range	0 - 6 (-3 - +3)
00 5F	0000 aaaa	Arpeggio Part Number	0 - 15 (PART1 - PART16)
Total size		00 00 00 60	

*1: (PERFORMANCE,PATCH,GM)

*2: (USER:01 - USER:32, <CARD:01 - CARD:32>, PR-A:01 - PR-A:32, PR-B:01 - PR-B:32)

*3: (USER&PRESET,<PCM>,<EXP>)

*4: (<OFF,HOLD-1,SOSTENUTO,SOFT,HOLD-2>)

*5: (OFF,HOLD-1,SOSTENUTO,SOFT,HOLD-2)

*6: (VOLUME,VOL&EXP)

*7: (CHANNEL,POLY,CH&POLY)

*8: (CC01 - CC05,CC07 - CC31,CC64 - CC95,PITCH BEND,AFTERTOUCH)

*9: (LIGHT,STANDARD,HEAVY)

*10: (CC01 - CC05,CC07 - CC31,CC64 - CC95, PITCH BEND, AFTERTOUCH, PROG-UP, PROG-DOWN, START/STOP, PUNCH-I/O, TAP-TEMPO, OCT-UP, OCT-DOWN)

*11: (OFF,INT,MIDI,INT&MIDI)

*12: (STANDARD,REVERSE)

*13: (CC01 - CC05,CC07 - CC31,CC64 - CC95, PITCH BEND,AFTERTOUCH)

1-1-2. Scale Tune

Offset Address	Description		
00 00	0aaa aaaa	Scale Tune for C	0 - 127 (-64 - +63)
00 01	0aaa aaaa	Scale Tune for C#	0 - 127 (-64 - +63)
00 02	0aaa aaaa	Scale Tune for D	0 - 127 (-64 - +63)
00 03	0aaa aaaa	Scale Tune for D#	0 - 127 (-64 - +63)
00 04	0aaa aaaa	Scale Tune for E	0 - 127 (-64 - +63)
00 05	0aaa aaaa	Scale Tune for F	0 - 127 (-64 - +63)
00 06	0aaa aaaa	Scale Tune for F#	0 - 127 (-64 - +63)
00 07	0aaa aaaa	Scale Tune for G	0 - 127 (-64 - +63)
00 08	0aaa aaaa	Scale Tune for G#	0 - 127 (-64 - +63)
00 09	0aaa aaaa	Scale Tune for A	0 - 127 (-64 - +63)
00 0A	0aaa aaaa	Scale Tune for A#	0 - 127 (-64 - +63)
00 0B	0aaa aaaa	Scale Tune for B	0 - 127 (-64 - +63)
Total size		00 00 00 0C	

1-2. Performance

Offset Address	Description		
00 00	Performance Common		1-2-1
10 00	Performance Part 1		1-2-2
11 00	Performance Part 2		
:	:		
1F 00	Performance Part 16		

1-2-1. Performance Common

Offset Address	Description		
00 00	0aaa aaaa	Performance Name 1	32 - 127
00 01	0aaa aaaa	Performance Name 2	32 - 127
00 02	0aaa aaaa	Performance Name 3	32 - 127
00 03	0aaa aaaa	Performance Name 4	32 - 127
00 04	0aaa aaaa	Performance Name 5	32 - 127
00 05	0aaa aaaa	Performance Name 6	32 - 127
00 06	0aaa aaaa	Performance Name 7	32 - 127
00 07	0aaa aaaa	Performance Name 8	32 - 127
00 08	0aaa aaaa	Performance Name 9	32 - 127
00 09	0aaa aaaa	Performance Name 10	32 - 127
00 0A	0aaa aaaa	Performance Name 11	32 - 127
00 0B	0aaa aaaa	Performance Name 12	32 - 127
00 0C	0000 aaaa	EFX Source	0 - 15 *1
00 0D	00aa aaaa	EFX Type	0 - 39 (1 - 40)
00 0E	0aaa aaaa	EFX Parameter 1	0 - 127
00 0F	0aaa aaaa	EFX Parameter 2	0 - 127
00 10	0aaa aaaa	EFX Parameter 3	0 - 127
00 11	0aaa aaaa	EFX Parameter 4	0 - 127
00 12	0aaa aaaa	EFX Parameter 5	0 - 127
00 13	0aaa aaaa	EFX Parameter 6	0 - 127
00 14	0aaa aaaa	EFX Parameter 7	0 - 127
00 15	0aaa aaaa	EFX Parameter 8	0 - 127
00 16	0aaa aaaa	EFX Parameter 9	0 - 127
00 17	0aaa aaaa	EFX Parameter 10	0 - 127
00 18	0aaa aaaa	EFX Parameter 11	0 - 127
00 19	0aaa aaaa	EFX Parameter 12	0 - 127
00 1A	0000 00aa	EFX Output Assign	0 - 2 *2
00 1B	0aaa aaaa	EFX Mix Out Send Level	0 - 127
00 1C	0aaa aaaa	EFX Chorus Send Level	0 - 127
00 1D	0aaa aaaa	EFX Reverb Send Level	0 - 127
00 1E	0000 aaaa	EFX Control Source 1	0 - 10 *3
00 1F	0aaa aaaa	EFX Control Depth 1	0 - 126 (-63 - +63)
00 20	0000 aaaa	EFX Control Source 2	0 - 10 *3
00 21	0aaa aaaa	EFX Control Depth 2	0 - 126 (-63 - +63)
00 22	0aaa aaaa	Chorus Level	0 - 127
00 23	0aaa aaaa	Chorus Rate	0 - 127
00 24	0aaa aaaa	Chorus Depth	0 - 127
00 25	0aaa aaaa	Chorus Pre-Delay	0 - 127
00 26	0aaa aaaa	Chorus Feedback	0 - 127
00 27	0000 00aa	Chorus Output	0 - 2 *4
00 28	0000 00aa	Reverb Type	0 - 7 *5
00 29	0aaa aaaa	Reverb Level	0 - 127
00 2A	0aaa aaaa	Reverb Time	0 - 127
00 2B	000a aaaa	Reverb HF Damp	0 - 17 *6
00 2C	0aaa aaaa	Delay Feedback	0 - 127
# 00 2D	0000 aaaa	Performance Tempo	20 - 250
00 2F	0000 hbbb 0000 000a	Keyboard Range Switch	0 - 1 (OFF,ON)
00 30	0aaa aaaa	Voice Reserve 1	0 - 64
00 31	0aaa aaaa	Voice Reserve 2	0 - 64
00 32	0aaa aaaa	Voice Reserve 3	0 - 64
00 33	0aaa aaaa	Voice Reserve 4	0 - 64
00 34	0aaa aaaa	Voice Reserve 5	0 - 64
00 35	0aaa aaaa	Voice Reserve 6	0 - 64
00 36	0aaa aaaa	Voice Reserve 7	0 - 64
00 37	0aaa aaaa	Voice Reserve 8	0 - 64
00 38	0aaa aaaa	Voice Reserve 9	0 - 64
00 39	0aaa aaaa	Voice Reserve 10	0 - 64
00 3A	0aaa aaaa	Voice Reserve 11	0 - 64
00 3B	0aaa aaaa	Voice Reserve 12	0 - 64
00 3C	0aaa aaaa	Voice Reserve 13	0 - 64
00 3D	0aaa aaaa	Voice Reserve 14	0 - 64
00 3E	0aaa aaaa	Voice Reserve 15	0 - 64
00 3F	0aaa aaaa	Voice Reserve 16	0 - 64
00 40	0000 000a	Keyboard Mode	0 - 1 (LAYER, SINGLE)
00 41	0000 000a	Clock Source	0 - 1 *7
Total size	00 00 00 42		

*1: (PERFORM,1 - 9,11 - 16)

*2: (MIX,DIR,<OUTPUT-2>)

*3: (OFF,SYS-CTRL1,SYS-CTRL2,MODULATION,BREATH,FOOT,VOLUME,PAN,EXPRESSION,PITCH BEND,AFTERTOUCH)

*4: (MIX,REVERB,MIX+REV)

*5: (ROOM1,ROOM2,STAGE1,STAGE2,HALL1,HALL2,DELAY,PAN-DLY)

*6: (200,250,315,400,500,630,800,1000,1250,1600,2000,2500,3150,4000,5000,6300,8000,BYPASS)

*7: (PERFORMANCE,SEQUENCER)

1-2-2. Performance Part

Offset Address	Description		
00 00	0000 000a	Receive Switch	0 - 1 (OFF,ON)
00 01	0000 aaaa	MIDI Channel	0 - 15 (1 - 16)
00 02	0000 00aa	Patch Group Type	0 - 2 1*
00 03	0aaa aaaa	Patch Group ID	0 - 127
# 00 04	0000 aaaa	Patch Number	0 - 254 (001 - 255)
00 06	0000 hbbb	Part Level	0 - 127
00 07	0aaa aaaa	Part Pan	0 - 127 (L64 - 63R)
00 08	0aaa aaaa	Part Coarse Tune	0 - 96 (-48 - +48)

00 09	0aaa aaaa	Part Fine Tune	0 - 100 (-50 - +50)
00 0A	0000 0aaa	Output Assign	0 - 4 2*
00 0B	0aaa aaaa	Mix/EFX Send Level	0 - 127
00 0C	0aaa aaaa	Chorus Send Level	0 - 127
00 0D	0aaa aaaa	Reverb Send Level	0 - 127
00 0E	0000 000a	Receive Program Change Switch	0 - 1 (OFF,ON)
00 0F	0000 000a	Receive Volume Switch	0 - 1 (OFF,ON)
00 10	0000 000a	Receive Hold-1 Switch	0 - 1 (OFF,ON)
00 11	0aaa aaaa	Keyboard Range Lower	0 - 127 (C-1 - Upper)
00 12	0aaa aaaa	Keyboard Range Upper	0 - 127 (Lower - G9)
00 13	0000 0aaa	Octave Shift	0 - 6 (-3 - +3)
00 14	0000 000a	Local Switch	0 - 1 (OFF,ON)
00 15	0000 000a	Transmit Switch	0 - 1 (OFF,ON)
# 00 16	0000 0aaa	Transmit Bank Select Group	0 - 7 3*
00 17	0000 aaaa	Transmit Volume	0 - 128 (0 - 127,OFF)
Total size	00 00 00 19		

1*: (USER&PRESET,<PCM>,EXP)

2*: (MIX,EFX,DIR,<OUTPUT-2>,PAT)

3*: (PATCH,GROUP1 - GROUP7)

1-3. Patch

Offset Address	Description		
00 00	Patch Common		1-3-1
10 00	Patch Tone 1		1-3-2
12 00	Patch Tone 2		
14 00	Patch Tone 3		
16 00	Patch Tone 4		

1-3-1. Patch Common

Offset Address	Description		
00 00	0aaa aaaa	Patch Name 1	32 - 127
00 01	0aaa aaaa	Patch Name 2	32 - 127
00 02	0aaa aaaa	Patch Name 3	32 - 127
00 03	0aaa aaaa	Patch Name 4	32 - 127
00 04	0aaa aaaa	Patch Name 5	32 - 127
00 05	0aaa aaaa	Patch Name 6	32 - 127
00 06	0aaa aaaa	Patch Name 7	32 - 127
00 07	0aaa aaaa	Patch Name 8	32 - 127
00 08	0aaa aaaa	Patch Name 9	32 - 127
00 09	0aaa aaaa	Patch Name 10	32 - 127
00 0A	0aaa aaaa	Patch Name 11	32 - 127
00 0B	0aaa aaaa	Patch Name 12	32 - 127
00 0C	00aa aaaa	EFX Type	0 - 39 (1 - 40)
00 0D	0aaa aaaa	EFX Parameter 1	0 - 127
00 0E	0aaa aaaa	EFX Parameter 2	0 - 127
00 0F	0aaa aaaa	EFX Parameter 3	0 - 127
00 10	0aaa aaaa	EFX Parameter 4	0 - 127
00 11	0aaa aaaa	EFX Parameter 5	0 - 127
00 12	0aaa aaaa	EFX Parameter 6	0 - 127
00 13	0aaa aaaa	EFX Parameter 7	0 - 127
00 14	0aaa aaaa	EFX Parameter 8	0 - 127
00 15	0aaa aaaa	EFX Parameter 9	0 - 127
00 16	0aaa aaaa	EFX Parameter 10	0 - 127
00 17	0aaa aaaa	EFX Parameter 11	0 - 127
00 18	0aaa aaaa	EFX Parameter 12	0 - 127
00 19	0000 00aa	EFX Output Assign	0 - 2 1*
00 1A	0aaa aaaa	EFX Mix Out Send Level	0 - 127
00 1B	0aaa aaaa	EFX Chorus Send Level	0 - 127
00 1C	0aaa aaaa	EFX Reverb Send Level	0 - 127
00 1D	0000 aaaa	EFX Control Source 1	0 - 10 2*
00 1E	0aaa aaaa	EFX Control Depth 1	0 - 126 (-63 - +63)
00 1F	0000 aaaa	EFX Control Source 2	0 - 10 2*
00 20	0aaa aaaa	EFX Control Depth 2	0 - 126 (-63 - +63)
00 21	0aaa aaaa	Chorus Level	0 - 127
00 22	0aaa aaaa	Chorus Rate	0 - 127
00 23	0aaa aaaa	Chorus Depth	0 - 127
00 24	0aaa aaaa	Chorus Pre-Delay	0 - 127
00 25	0aaa aaaa	Chorus Feedback	0 - 127
00 26	0000 00aa	Chorus Output	0 - 2 3*
00 27	0000 0aaa	Reverb Type	0 - 7 4*
00 28	0aaa aaaa	Reverb Level	0 - 127
00 29	0aaa aaaa	Reverb Time	0 - 127
00 2A	000a aaaa	Reverb HF Damp	0 - 17 5*
00 2B	0aaa aaaa	Delay Feedback	0 - 127
# 00 2C	0000 aaaa	Patch Tempo	20 - 250
00 2E	0aaa aaaa	Patch Level	0 - 127
00 2F	0aaa aaaa	Patch Pan	0 - 127 (L64 - 63R)
00 30	0aaa aaaa	Analog Peel	0 - 127
00 31	0000 aaaa	Bend Range Up	0 - 12
00 32	00aa aaaa	Bend Range Down	0 - 48 (0 - -48)
00 33	0000 000a	Key Assign Mode	0 - 1 (POLY, SOLO)
00 34	0000 000a	Solo Legato	0 - 1 (OFF,ON)
00 35	0000 000a	Portamento Switch	0 - 1 (OFF,ON)
00 36	0000 000a	Portamento Mode	0 - 1

00 37	0000 000a	Portamento Type	(NORMAL,LEGATO) 0 - 1	00 26	0aaa aaaa	Controller 3 Depth 1	0 - 126 (-63 - +63)
00 38	0000 000a	Portamento Start	(RATE,TIME) 0 - 1	00 27	000a aaaa	Controller 3 Destination 2	0 - 18 3*
00 39	0aaa aaaa	Portamento Time	(PITCH,NOTE) 0 - 127	00 28	0aaa aaaa	Controller 3 Depth 2	0 - 126 (-63 - +63)
00 3A	0000 aaaa	Patch Control Source 2	0 - 15 6*	00 29	000a aaaa	Controller 3 Destination 3	0 - 18 3*
00 3B	0000 aaaa	Patch Control Source 3	0 - 15 6*	00 2A	0aaa aaaa	Controller 3 Depth 3	0 - 126 (-63 - +63)
00 3C	0000 00aa	EFX Control Hold/Peak	0 - 2 7*	00 2B	000a aaaa	Controller 3 Destination 4	0 - 18 3*
00 3D	0000 00aa	Control 1 Hold/Peak	0 - 2 7*	00 2C	0aaa aaaa	Controller 3 Depth 4	0 - 126 (-63 - +63)
00 3E	0000 00aa	Control 2 Hold/Peak	0 - 2 7*				
00 3F	0000 00aa	Control 3 Hold/Peak	0 - 2 7*				
00 40	0000 000a	Velocity Range Switch	0 - 1	00 2D	0000 0aaa	LF01 Waveform	0 - 7 4*
00 41	0000 0aaa	Octave Shift	(OFF,ON) 0 - 6	00 2E	0000 000a	LF01 Key Trigger	0 - 1 (OFF,ON)
00 42	0000 00aa	Stretch Tune Depth	(-3 - +3) 0 - 3	00 2F	0aaa aaaa	LF01 Rate	0 - 127
00 43	0000 000a	Voice Priority	(OFF,1 - 3) 0 - 1	00 30	0000 0aaa	LF01 Offset	0 - 4 5*
			(LAST,LOUDEST)	00 31	0aaa aaaa	LF01 Delay Time	0 - 127
				00 32	0000 00aa	LF01 Fade Mode	0 - 3 6*
				00 33	0aaa aaaa	LF01 Fade Time	0 - 127
				00 34	0000 00aa	LF01 External Sync	0 - 2 7*
00 44	0000 aaaa	Structure Type 1&2	0 - 9 (1 - 10)	00 35	0000 0aaa	LF02 Waveform	0 - 7 4*
00 45	0000 00aa	Booster 1&2	0 - 3 8*	00 36	0000 000a	LF02 Key Trigger	0 - 1 (OFF,ON)
00 46	0000 aaaa	Structure Type 3&4	0 - 9 (1 - 10)	00 37	0aaa aaaa	LF02 Rate	0 - 127
00 47	0000 00aa	Booster 3&4	0 - 3 8*	00 38	0000 0aaa	LF02 Offset	0 - 4 5*
00 48	0000 000a	Clock Source	0 - 1 9*	00 39	0aaa aaaa	LF02 Delay Time	0 - 127
				00 3A	0000 00aa	LF02 Fade Mode	0 - 3 6*
				00 3B	0aaa aaaa	LF02 Fade Time	0 - 127
				00 3C	0000 00aa	LF02 External Sync	0 - 2 7*
Total size	00 00 00 49						

- 1*: (MIX,DIR,<OUTPUT-2>)
2*: (OFF,SYS-CTRL1,SYS-CTRL2,MODULATION,BREATH,FOOT,VOLUME,PAN,EXPRESSION,PITCH BEND,AFTERTOUCH)
3*: (MIX,REVERB,MIX+REV)
4*: (ROOM1,ROOM2,STAGE1,STAGE2,HALL1,HALL2,DELAY,PAN-DLY)
5*: (200,250,315,400,500,630,800,1000,1250,1600,2000,2500,3150,4000,5000,6300,8000,BYPASS)
6*: (OFF,SYS-CTRL1,SYS-CTRL2,MODULATION,BREATH,FOOT,VOLUME,PAN,EXPRESSION,PITCH BEND,AFTERTOUCH,LF01,LF02,VELOCITY,KEYFOLLOW,PLAYMATE)
7*: (OFF,HOLD,PEAK)
8*: (0,+6,+12,+18)
9*: (PATCH,SEQUENCER)

1-3-2.Patch Tone

Offset Address	Description		
00 00	0000 000a	Tone Switch	0 - 1 (OFF,ON)
00 01	0000 00aa	Wave Group Type	0 - 2 (INT,<PCM>,EXP)
00 02	0aaa aaaa	Wave Group ID	0 - 127
00 03	0000 aaaa	Wave Number	0 - 254 (001 - 255)
00 05	0000 00aa	Wave Gain	0 - 3 (-6,0,+6,+12)
00 06	0000 000a	FXM Switch	0 - 1 (OFF,ON)
00 07	0000 00aa	FXM Color	0 - 3 (1 - 4)
00 08	0000 aaaa	FXM Depth	0 - 15 (1 - 16)
00 09	0000 0aaa	Tone Delay Mode	0 - 7 1*
00 0A	0aaa aaaa	Tone Delay Time	0 - 127
00 0B	0aaa aaaa	Velocity Cross Fade	0 - 127
00 0C	0aaa aaaa	Velocity Range Lower	1 - 127 (1 - Upper)
00 0D	0aaa aaaa	Velocity Range Upper	1 - 127 (Lower - 127)
00 0E	0aaa aaaa	Keyboard Range Lower	0 - 127 (C-1 - Upper)
00 0F	0aaa aaaa	Keyboard Range Upper	0 - 127 (Lower - G9)
00 10	0000 000a	Redamper Control Switch	0 - 1 (OFF,ON)
00 11	0000 000a	Volume Control Switch	0 - 1 (OFF,ON)
00 12	0000 000a	Hold-1 Control Switch	0 - 1 (OFF,ON)
00 13	0000 000a	Bender Control Switch	0 - 1 (OFF,ON)
00 14	0000 00aa	Pan Control Switch	0 - 2 2*
00 15	000a aaaa	Controller 1 Destination 1	0 - 18 3*
00 16	0aaa aaaa	Controller 1 Depth 1	0 - 126 (-63 - +63)
00 17	000a aaaa	Controller 1 Destination 2	0 - 18 3*
00 18	0aaa aaaa	Controller 1 Depth 2	0 - 126 (-63 - +63)
00 19	000a aaaa	Controller 1 Destination 3	0 - 18 3*
00 1A	0aaa aaaa	Controller 1 Depth 3	0 - 126 (-63 - +63)
00 1B	000a aaaa	Controller 1 Destination 4	0 - 18 3*
00 1C	0aaa aaaa	Controller 1 Depth 4	0 - 126 (-63 - +63)
00 1D	000a aaaa	Controller 2 Destination 1	0 - 18 3*
00 1E	0aaa aaaa	Controller 2 Depth 1	0 - 126 (-63 - +63)
00 1F	000a aaaa	Controller 2 Destination 2	0 - 18 3*
00 20	0aaa aaaa	Controller 2 Depth 2	0 - 126 (-63 - +63)
00 21	000a aaaa	Controller 2 Destination 3	0 - 18 3*
00 22	0aaa aaaa	Controller 2 Depth 3	0 - 126 (-63 - +63)
00 23	000a aaaa	Controller 2 Destination 4	0 - 18 3*
00 24	0aaa aaaa	Controller 2 Depth 4	0 - 126 (-63 - +63)
00 25	000a aaaa	Controller 3 Destination 1	0 - 18 3*
00 50	0000 0aaa	Filter Type	0 - 4 11*
00 51	0aaa aaaa	Cutoff Frequency	0 - 127
00 52	0000 aaaa	Cutoff Keyfollow	0 - 15 9*
00 53	0aaa aaaa	Resonance	0 - 127
00 54	0aaa aaaa	Resonance Velocity Sens	0 - 125 (-100 - +150)
00 55	0aaa aaaa	Filter Envelope Depth	0 - 126 (-63 - +63)
00 56	0000 0aaa	Filter Envelope Velocity Curve	0 - 6 (1 - 7)
00 57	0aaa aaaa	Filter Envelope Velocity Sens	0 - 125 (-100 - +150)
00 58	0000 aaaa	Filter Envelope Velocity Time1	0 - 14 10*
00 59	0000 aaaa	Filter Envelope Velocity Time4	0 - 14 10*
00 5A	0000 aaaa	Filter Envelope Time Keyfollow	0 - 14 10*
00 5B	0aaa aaaa	Filter Envelope Time 1	0 - 127
00 5C	0aaa aaaa	Filter Envelope Time 2	0 - 127
00 5D	0aaa aaaa	Filter Envelope Time 3	0 - 127
00 5E	0aaa aaaa	Filter Envelope Time 4	0 - 127
00 5F	0aaa aaaa	Filter Envelope Level 1	0 - 127
00 60	0aaa aaaa	Filter Envelope Level 2	0 - 127
00 61	0aaa aaaa	Filter Envelope Level 3	0 - 127
00 62	0aaa aaaa	Filter Envelope Level 4	0 - 127
00 63	0aaa aaaa	Filter LF01 Depth	0 - 126 (-63 - +63)
00 64	0aaa aaaa	Filter LF02 Depth	0 - 126 (-63 - +63)
00 65	0aaa aaaa	Tone Level	0 - 127
00 66	0000 00aa	Bias Direction	0 - 3 *13
00 67	0aaa aaaa	Bias Position	0 - 127 (C-1 - G9)
00 68	0000 aaaa	Bias Level	0 - 14 10*
00 69	0000 0aaa	Level Envelope Velocity Curve	0 - 6 (1 - 7)
00 6A	0aaa aaaa	Level Envelope Velocity Sens	0 - 125 (-100 - +150)
00 6B	0000 aaaa	Level Envelope Velocity Time1	0 - 14 10*
00 6C	0000 aaaa	Level Envelope Velocity Time4	0 - 14 10*
00 6D	0000 aaaa	Level Envelope Time Keyfollow	0 - 14 10*
00 6E	0aaa aaaa	Level Envelope Time 1	0 - 127
00 6F	0aaa aaaa	Level Envelope Time 2	0 - 127
00 70	0aaa aaaa	Level Envelope Time 3	0 - 127
00 71	0aaa aaaa	Level Envelope Time 4	0 - 127
00 72	0aaa aaaa	Level Envelope Level 1	0 - 127
00 73	0aaa aaaa	Level Envelope Level 2	0 - 127
00 74	0aaa aaaa	Level Envelope Level 3	0 - 127
00 75	0aaa aaaa	Level LF01 Depth	0 - 126 (-63 - +63)
00 76	0aaa aaaa	Level LF02 Depth	0 - 126 (-63 - +63)
00 77	0aaa aaaa	Tone Pan	0 - 127 (L64 - 63R)
00 78	0000 aaaa	Pan Keyfollow	0 - 14 10*
00 79	00aa aaaa	Random Pan Depth	0 - 63
00 7A	0aaa aaaa	Alternate Pan Depth	1 - 127 (L63 - 63R)

00 7B	0aaa aaaa	Pan LFO1 Depth	0 - 126 (-63 - +63)
00 7C	0aaa aaaa	Pan LFO2 Depth	0 - 126 (-63 - +63)
00 7D	0000 00aa	Output Assign	0 - 3 12*
00 7E	0aaa aaaa	Mix/EFX Send Level	0 - 127
00 7F	0aaa aaaa	Chorus Send Level	0 - 127
01 00	0aaa aaaa	Reverb Send Level	0 - 127
Total size		00 00 01 01	

- 1*: (NORMAL,HOLD,PLAYMATE,CLOCK-SYNC,<TAP-SYNC>,KEY-OFF-N,KEY-OFF-D,TEMPO-SYNC)
- 2*: (OFF,CONTINUOUS,KEY-ON)
- 3*: (OFF,PCH,CUT,RES,LEV,PAN,MIX,CHO,REV,PL1,PL2,FL1,FL2,AL1,AL2,pL1,pL2,L1R,L2R)
- 4*: (TRI,SIN,SAW,SQR,TRP,S&H,RND,CHS)
- 5*: (-100,-50.0,+50,+100)
- 6*: (ON-IN,ON-OUT,OFF-IN,OFF-OUT)
- 7*: (OFF,CLOCK,<TAP>)
- 8*: (0,1,2,3,4,5,6,7,8,9,10,20,30,40,50,60,70,80,90,100,200,300,400,500,600,700,800,900,1000,1100,1200)
- 9*: (-100,-70,-50,-30,-10,0,+10,+20,+30,+40,+50,+70,+100,+120,+150,+200)
- 10*: (-100,-70,-50,-40,-30,-20,-10,0,+10,+20,+30,+40,+50,+70,+100)
- 11*: (OFF,LPF,BPF,HPF,PKG)
- 12*: (MIX,EFX,DIR,<OUTPUT-2>)
- 13*: (LOWER,UPPER,LOW&UP,ALL)

1-4.Rhythm Setup

Offset	Address	Description	
00 00	Rhythm Common		1-4-1
23 00	Rhythm Note for Key# 35		1-4-2
24 00	Rhythm Note for Key# 36		
:	:		
62 00	Rhythm Note for Key# 98		
Total size		00 00 00 0C	

1-4-1.Rhythm Common

Offset	Address	Description	
00 00	0aaa aaaa	Rhythm Name 1	32 - 127
00 01	0aaa aaaa	Rhythm Name 2	32 - 127
00 02	0aaa aaaa	Rhythm Name 3	32 - 127
00 03	0aaa aaaa	Rhythm Name 4	32 - 127
00 04	0aaa aaaa	Rhythm Name 5	32 - 127
00 05	0aaa aaaa	Rhythm Name 6	32 - 127
00 06	0aaa aaaa	Rhythm Name 7	32 - 127
00 07	0aaa aaaa	Rhythm Name 8	32 - 127
00 08	0aaa aaaa	Rhythm Name 9	32 - 127
00 09	0aaa aaaa	Rhythm Name 10	32 - 127
00 0A	0aaa aaaa	Rhythm Name 11	32 - 127
00 0B	0aaa aaaa	Rhythm Name 12	32 - 127
Total size		00 00 00 0C	

1-4-2.Rhythm Note

Offset	Address	Description	
00 00	0000 000a	Tone Switch	0 - 1 (OFF,CN)
00 01	0000 00aa	Wave Group Type	0 - 2 (INF,<PCM>,EXP)
00 02	0aaa aaaa	Wave Group ID	0 - 127
# 00 03	0000 aaaa	Wave Number	0 - 254 (001 - 255)
00 05	0000 00aa	Wave Gain	0 - 3 (-6,0,+6,+12)
00 06	0000 aaaa	Bend Range	0 - 12
00 07	000a aaaa	Mute Group	0 - 31 (OFF,1 - 31)
00 08	0000 000a	Envelope Mode	0 - 1 1*
00 09	0000 000a	Volume Control Switch	0 - 1 (OFF,CN)
00 0A	0000 000a	Hold-1 Control Switch	0 - 1 (OFF,CN)
00 0B	0000 00aa	Pan Control Switch	0 - 2 2*
00 0C	0aaa aaaa	Source Key	0 - 127 (C-1 - G9)
00 0D	0aaa aaaa	Fine Tune	0 - 100 (-50 - +50)
00 0E	000a aaaa	Random Pitch Depth	0 - 30 3*
00 0F	000a aaaa	Pitch Envelope Depth	0 - 24 (-12 - +12)
00 10	0aaa aaaa	Pitch Envelope Velocity Sens	0 - 125 (-100 - +150)
00 11	0000 aaaa	Pitch Envelope Velocity Time	0 - 14 4*
00 12	0aaa aaaa	Pitch Envelope Time 1	0 - 127
00 13	0aaa aaaa	Pitch Envelope Time 2	0 - 127
00 14	0aaa aaaa	Pitch Envelope Time 3	0 - 127
00 15	0aaa aaaa	Pitch Envelope Time 4	0 - 127
00 16	0aaa aaaa	Pitch Envelope Level 1	0 - 126 5*
00 17	0aaa aaaa	Pitch Envelope Level 2	0 - 126 5*
00 18	0aaa aaaa	Pitch Envelope Level 3	0 - 126 5*
00 19	0aaa aaaa	Pitch Envelope Level 4	0 - 126 5*
00 1A	0000 00aa	Filter Type	0 - 4 6*

00 1B	0aaa aaaa	Cutoff Frequency	0 - 127
00 1C	0aaa aaaa	Resonance	0 - 127
00 1D	0aaa aaaa	Resonance Velocity Sens	0 - 125 (-100 - +150)
00 1E	0aaa aaaa	Filter Envelope Depth	0 - 126 5*
00 1F	0aaa aaaa	Filter Envelope Velocity Sens	0 - 125 (-100 - +150)
00 20	0000 aaaa	Filter Envelope Velocity Time	0 - 14 4*
00 21	0aaa aaaa	Filter Envelope Time 1	0 - 127
00 22	0aaa aaaa	Filter Envelope Time 2	0 - 127
00 23	0aaa aaaa	Filter Envelope Time 3	0 - 127
00 24	0aaa aaaa	Filter Envelope Time 4	0 - 127
00 25	0aaa aaaa	Filter Envelope Level 1	0 - 127
00 26	0aaa aaaa	Filter Envelope Level 2	0 - 127
00 27	0aaa aaaa	Filter Envelope Level 3	0 - 127
00 28	0aaa aaaa	Filter Envelope Level 4	0 - 127
00 29	0aaa aaaa	Tone Level	0 - 127
00 2A	0aaa aaaa	Level Envelope Velocity Sens	0 - 125 (-100 - +150)
00 2B	0000 aaaa	Level Envelope Velocity Time	0 - 14 4*
00 2C	0aaa aaaa	Level Envelope Time 1	0 - 127
00 2D	0aaa aaaa	Level Envelope Time 2	0 - 127
00 2E	0aaa aaaa	Level Envelope Time 3	0 - 127
00 2F	0aaa aaaa	Level Envelope Time 4	0 - 127
00 30	0aaa aaaa	Level Envelope Level 1	0 - 127
00 31	0aaa aaaa	Level Envelope Level 2	0 - 127
00 32	0aaa aaaa	Level Envelope Level 3	0 - 127
00 33	0aaa aaaa	Tone Pan	0 - 127 (L64 - 63R)
00 34	00aa aaaa	Random Pan Depth	0 - 63
00 35	0aaa aaaa	Alternate Pan Depth	1 - 127 (L63 - 63R)
00 36	0000 00aa	Output Assign	0 - 3 7*
00 37	0aaa aaaa	Mix/EFX Send Level	0 - 127
00 38	0aaa aaaa	Chorus Send Level	0 - 127
00 39	0aaa aaaa	Reverb Send Level	0 - 127
Total size		00 00 00 3A	

- 1*: (NO-SUS,SUSTAIN)
- 2*: (OFF,CONTINUOUS,KEY-ON)
- 3*: (0,1,2,3,4,5,6,7,8,9,10,20,30,40,50,60,70,80,90,100,200,300,400,500,600,700,800,900,1000,1100,1200)
- 4*: (-100,-70,-50,-40,-30,-20,-10,0,+10,+20,+30,+40,+50,+70,+100)
- 5*: (-63 - +63)
- 6*: (OFF,LPF,BPF,HPF,PKG)
- 7*: (MIX,EFX,DIR,<OUTPUT-2>)

■ Address block map

The following is an outline of the address map for Exclusive messages.

Address(H)	Block	Sub Block	Reference
00 00 00 00	System common		1-1-1
	Scale tune	Part 1	1-1-2
		:	
		Part 16	
		:	
		Patch	
01 00 00 00	Temporary performance	Common	1-2-1
		Part 1	1-2-2
		:	
		Part 16	
02 00 00 00	Performance mode temporary patch	Part 1	1-3-1
		:	
		Part 9	1-3-2
		:	
		Tone 1	
		:	
		Tone 4	
02 09 00 00	Temporary rhythm setup	Common	1-4-1
		Note# 35	1-4-2
		:	
		Note# 98	
02 0A 00 00	Performance mode temporary patch	Part 11	1-3-1
		:	
		Part 16	1-3-2
		:	
		Tone 1	
		:	
		Tone 4	
03 00 00 00	Patch mode temporary patch	Common	1-3-1
		Tone 1	1-3-2
		:	
		Tone 4	
10 00 00 00	User performance	USER:01	1-2-1
		:	
		Part 1	1-2-2
		:	
		Part 16	
10 40 00 00	User rhythm setup	USER:1	1-4-1
		USER:2	1-4-2
		:	
		Note# 35	
		:	
		Note# 98	
11 00 00 00	User patch	USER:001	1-3-1
		:	
		USER:128	1-3-2
		:	
		Tone 1	
		:	
		Tone 4	

2.GS (Model ID = 42H)

Start address	Description
40 10 00	Scale Tune Part10
40 11 00	: Part1
40 12 00	: Part2
40 13 00	: Part3
40 14 00	: Part4
40 15 00	: Part5
40 16 00	: Part6
40 17 00	: Part7
40 18 00	: Part8
40 19 00	: Part9
40 1A 00	: Part11
40 1B 00	: Part12
40 1C 00	: Part13
40 1D 00	: Part14
40 1E 00	: Part15
40 1F 00	: Part16

2-1.Scale Tune

Offset Address	Description
40 0aaa aaaa	Scale Tune for C 0 - 127 (-64 - +63)
41 0aaa aaaa	Scale Tune for C# 0 - 127 (-64 - +63)
42 0aaa aaaa	Scale Tune for D 0 - 127 (-64 - +63)
43 0aaa aaaa	Scale Tune for D# 0 - 127 (-64 - +63)
44 0aaa aaaa	Scale Tune for E 0 - 127 (-64 - +63)
45 0aaa aaaa	Scale Tune for F 0 - 127 (-64 - +63)
46 0aaa aaaa	Scale Tune for F# 0 - 127 (-64 - +63)
47 0aaa aaaa	Scale Tune for G 0 - 127 (-64 - +63)
48 0aaa aaaa	Scale Tune for G# 0 - 127 (-64 - +63)
49 0aaa aaaa	Scale Tune for A 0 - 127 (-64 - +63)
4A 0aaa aaaa	Scale Tune for A# 0 - 127 (-64 - +63)
4B 0aaa aaaa	Scale Tune for B 0 - 127 (-64 - +63)
Total Size	00 00 0C

Note: In order for a GS Exclusive message to be correctly received by the XP-60/XP-80, the starting address of the message must be the Start address of each Part (the address of Scale Tune C, i.e., offset 40).

6. Supplementary material

● Decimal/Hexadecimal table (hexadecimal values are indicated by a following 'H')

MIDI uses 7-bit hexadecimal values to indicate data values and the address and size of exclusive messages. The following table shows the correspondence between decimal and hexadecimal numbers.

D	H	D	H	D	H	D	H
0	00H	32	20H	64	40H	96	60H
1	01H	33	21H	65	41H	97	61H
2	02H	34	22H	66	42H	98	62H
3	03H	35	23H	67	43H	99	63H
4	04H	36	24H	68	44H	100	64H
5	05H	37	25H	69	45H	101	65H
6	06H	38	26H	70	46H	102	66H
7	07H	39	27H	71	47H	103	67H
8	08H	40	28H	72	48H	104	68H
9	09H	41	29H	73	49H	105	69H
10	0AH	42	2AH	74	4AH	106	6AH
11	0BH	43	2BH	75	4BH	107	6BH
12	0CH	44	2CH	76	4CH	108	6CH
13	0DH	45	2DH	77	4DH	109	6DH
14	0EH	46	2EH	78	4EH	110	6EH
15	0FH	47	2FH	79	4FH	111	6FH
16	10H	48	30H	80	50H	112	70H
17	11H	49	31H	81	51H	113	71H
18	12H	50	32H	82	52H	114	72H
19	13H	51	33H	83	53H	115	73H
20	14H	52	34H	84	54H	116	74H
21	15H	53	35H	85	55H	117	75H
22	16H	54	36H	86	56H	118	76H
23	17H	55	37H	87	57H	119	77H
24	18H	56	38H	88	58H	120	78H
25	19H	57	39H	89	59H	121	79H
26	1AH	58	3AH	90	5AH	122	7AH
27	1BH	59	3BH	91	5BH	123	7BH
28	1CH	60	3CH	92	5CH	124	7CH
29	1DH	61	3DH	93	5DH	125	7DH
30	1EH	62	3EH	94	5EH	126	7EH
31	1FH	63	3FH	95	5FH	127	7FH

D:decimal

H:hexadecimal

- * Decimal expressions such as used for MIDI channel, Bank Select, and Program Change will be the value 1 greater than the decimal value given in the above table.
- * Since each MIDI byte carries 7 significant data bits, each byte can express a maximum of 128 different values. Data for which higher resolution is required must be transmitted using two or more bytes. For example a value indicated as a two-byte value of aa bbH would have a value of aa x 128 + bb.
- * For a signed number (+/-), 00H = -64, 40H = +/-0, and 7FH = +63. I.e., the decimal equivalent will be 64 less than the decimal value given in the above table. For a two-byte signed number, 00 00H = -8192, 40 00H = +/-0, and 7F 7FH = +8191. For example the decimal expression of aa bbH would be aa bbH - 40 00H = (aa x 128 + bb - 64 x 128).
- * Hexadecimal notation in two 4-bit units is used for data indicated as "nibbled". The nibbled two-byte value of 0a 0b H would be a x 16 + b.

<Example 1> What is the decimal equivalent of 5AH?
From the above table, 5AH = 90.

<Example 2> What is the decimal equivalent of the 7-bit hexadecimal values 12 34H?
From the above table, 12H = 18 and 34H = 52
Thus, 18 x 128 + 52 = 2356

<Example 3> What is the decimal equivalent of the nibbled expression 0A 03 09 0DH?
From the above table, 0AH = 10, 03H = 3, 09H = 9, 0DH = 13
Thus, the result is ((10 x 16 + 3) x 16 + 9) x 16 + 13 = 41885

<Example 4> What is the nibbled equivalent of the decimal number 1258?

```

16 ) 1258
   78  ...10
   --
    4  ...14
    0  ... 4

```

From the above table, 0=00H, 4=04H, 14=0EH, 10=0AH
Thus the result is 00 04 0E 0AH

● **Examples of actual MIDI messages**

<Example 1> 92 3E 5F
9n is the Note On status and 'n' is the MIDI channel number. Since 2H = 2, 3EH = 62, and 5FH = 95, this is a Note On message of MIDI CH = 3, note number 62 (note name D4) and velocity 95.

<Example 2> CE 49
CnH is the Program Change status and 'n' is the MIDI channel number. Since EH = 14, and 49H = 73, this is a Program Change message of MIDI CH = 15, Program number 74 (in the GS sound map, Flute).

<Example 3> EA 00 28
EnH is the Pitch Bend Change status and 'n' is the MIDI channel number. The 2nd byte (00H=0) is the LSB of the Pitch Bend value, and the 3rd byte (28H=40) is the MSB. However since the Pitch Bend is a signed number with 0 at 40 00H (= 64 x 128 + 0 = 8192), the Pitch Bend value in this case is
28 00H - 40 00H = 40 x 128 + 0 - (64 x 128 + 0) = 5120 - 8192 = -3072

If we assume that the Pitch Bend Sensitivity is set to two semitones, the pitch will change only -200 cents for a Pitch Bend value of -8192 (00 00H). Thus, this message is specifying a Pitch Bend of -200 x (-3072) ÷ (-8192) = -75 cents on MIDI CH = 11.

<Example 4> B3 64 00 65 00 06 0C 26 00 64 7F 65 7F
BnH is the Control Change status, and 'n' is the MIDI channel number. In Control Change messages, the 2nd byte is the controller number, and the 3rd byte is the parameter value. MIDI allows what is known as "running status," when if messages of the the same status follow each other, it is permitted to omit the second and following status bytes. In the message above, running status is being used, meaning that the message has the following content.

B3 64 00 MIDI CH = 4, RPN parameter number LSB : 00H
(B3) 65 00 MIDI CH = 4, RPN parameter number MSB : 00H
(B3) 06 0C MIDI CH = 4, parameter value MSB : 0CH
(B3) 26 00 MIDI CH = 4, parameter value LSB : 00H
(B3) 64 7F MIDI CH = 4, RPN parameter number LSB : 7FH
(B3) 65 7F MIDI CH = 4, RPN parameter number MSB : 7FH

Thus, this message transmits a parameter value of 0C 00H to RPN parameter number 00 00H on MIDI CH = 4, and then sets the RPN parameter number to 7F 7FH.

The function assigned to RPN parameter number 00 00H is Pitch Bend Sensitivity, and the MSB of the parameter value indicates semitone steps. Since the MSB of this parameter value is 0CH = 12, the maximum width of pitch bend is being set to ±12 semitones (1 octave) (GS sound sources ignore the LSB of Pitch Bend Sensitivity, but it is best to transmit the LSB (parameter value 0) as well, so that the message can be correctly received by any device.

Once the parameter number has been set for RPN or NRPN, all subsequent Data Entry messages on that channel will be effective. Thus, it is recommended that after you have made the change you want, you set the parameter number to 7F 7FH (an "unset" or "null" setting). The final (B3) 64 7F (B3) 65 7F is for this purpose.

It is not a good idea to store many events within the data of a song (e.g., a Standard MIDI File song) using running status as shown in <Example 4>. When the song is paused, fast-forwarded or rewound, the sequencer may not be able to transmit the proper status, causing the sound source to misinterpret the data. It is best to attach the proper status byte to all events.

It is also important to transmit RPN or NRPN parameter number settings and parameter values in the correct order. In some sequencers, data events recorded in the same clock (or a nearby clock) can sometimes be transmitted in an order other than the order in which they were recorded. It is best to record such events at an appropriate interval (1 tick at TPQN=96, or 5 ticks at TPQN=480).

* TPQN : Ticks Per Quarter Note (i.e., the time resolution of the sequencer)

● **Examples of exclusive messages and calculating the checksum**

Roland exclusive messages (RQ1, DT1) are transmitted with a checksum at the end of the data (before F7) to check that the data was received correctly. The value of the checksum is determined by the address and data (or size) of the exclusive message.

○ **How to calculate the checksum (hexadecimal values are indicated by a 'H')**

The checksum consists of a value whose lower 7 bits are 0 when the address, size and checksum itself are added. The following formula shows how to calculate the checksum when the exclusive message to be transmitted has an address of aa bb cc ddH, and data or size of ee ffH.

$$\begin{aligned}
 aa + bb + cc + dd + ee + ff &= \text{total} \\
 \text{total} \div 128 &= \text{quotient} \dots \text{remainder} \\
 128 - \text{remainder} &= \text{checksum}
 \end{aligned}$$

<Example 1> Setting the Performance Common REVERB TYPE to DELAY (DT1).

The "Parameter address map" indicates that the starting address of the Temporary Performance is 01 00 00 00H, that the Performance Common offset address is 00 00H, and that the REVERB TYPE address is 00 28H. Thus, the address is:

```

01 00 00 00H
00 00H
+) 00 28H
-----
01 00 00 28H

```

Since DELAY is parameter value 06H,

```

F0 41 10 6A 12 01 00 00 28 06 ?? F7
(1) (2) (3) (4) (5) address data checksum (6)

```

- (1) Exclusive status
- (2) ID number (Roland)
- (3) device ID(17)
- (4) model ID (XP-60/XP-80)
- (5) command ID (DT1)
- (6) EOX

Next we calculate the checksum.

$$\begin{aligned}
 01H + 00H + 00H + 28H + 06H &= 1 + 0 + 0 + 40 + 6 = 47 \text{ (sum)} \\
 47 \text{ (total)} \div 128 &= 0 \text{ (quotient)} \dots 47 \text{ (remainder)} \\
 \text{checksum} &= 128 - 47 \text{ (quotient)} = 81 = 51H
 \end{aligned}$$

This means that the message transmitted will be F0 41 10 6A 12 01 00 00 28 06 51 F7.

<Example 2> Retrieving data for USER:03 Performance Part 3 (RQ1)

The "Parameter address map" indicates that the starting address of USER:03 is 10 02 00 00H, and that the offset address of Performance Part 3 is 12 00H. Thus, the address is:

```

10 02 00 00H
+) 12 00H
-----
10 02 12 00H

```

Since the size of the Performance Part is 00 00 00 19H,

```
F0 41 10 6A 11 10 02 12 00 00 00 00 19 ?? F7
(1) (2) (3) (4) (5) address size checksum (6)
```

- (1) Exclusive status (2) ID number (Roland) (3) Device ID (17)
 (4) Model ID (XP-60/XP-80) (5) Command ID (RQ1) (6) EOX

Next we calculate the checksum.

$$10H + 02H + 12H + 00H + 00H + 00H + 00H + 19H = 16 + 2 + 18 + 0 + 0 + 0 + 0 + 25 = 61 \text{ (sum)}$$

$$61 \text{ (total)} / 128 = 0 \text{ (product)} \dots 61 \text{ (remainder)}$$

$$\text{checksum} = 128 - 61 \text{ (remainder)} = 67 = 43H$$

Thus, a message of F0 41 10 6A 11 10 02 12 00 00 00 00 19 43 F7 would be transmitted.

<Example 3> Retrieving data for Temporary Performance (RQ1)

Note: When a data transfer is executed in Utility mode, data that is accessed will be the same as that which is transmitted when the Type parameter is set to PERFORM and the Source parameter is set to TEMP: -PATCH

The "Parameter address map" gives the following start addresses for Temporary Performance data.

01 00 00 00H	Temporary Performance Common
01 00 10 00H	Temporary Performance Part 1
:	
01 00 1F 00H	Temporary Performance Part 16

Since Performance Part has a size of 00 00 00 19H, we add that size to the start address of the Temporary Performance Part 16, resulting in:

$$\begin{array}{r} 01\ 00\ 1F\ 00H \\ +) 00\ 00\ 00\ 19H \\ \hline 01\ 00\ 1F\ 19H \end{array}$$

Thus, the Size for the retrieved data will be:

$$\begin{array}{r} 01\ 00\ 1F\ 19H \\ -) 01\ 00\ 00\ 00H \\ \hline 00\ 00\ 1F\ 19H \end{array}$$

```
F0 41 10 6A 11 01 00 00 00 00 00 1F 19 ?? F7
(1) (2) (3) (4) (5) address size checksum (6)
```

- (1) Exclusive status (2) ID number (Roland) (3) device ID(17)
 (4) Model ID (XP-60/XP-80) (5) command ID (RQ1) (6) EOX

Calculating the checksum as shown in <Example 2>, we get a message of F0 41 10 6A 11 01 00 00 00 00 00 1F 19 47 F7 to be transmitted.

<Example 4> Retrieving the Temporary Performance data together with all Temporary Part and Rhythm Set data (RQ1)

Note: When a data transfer is executed in Utility mode, the data that is accessed will be the same as that which is transmitted when the Type parameter is set to PERFORM and the Source parameter is set to TEMP: +PATCH

The "Parameter address map" gives the following start addresses for Temporary Performance, Performance Mode Temporary Patch and Performance Mode Temporary Rhythm.

01 00 00 00H	Temporary Performance
02 00 00 00H	Performance Mode Temporary Patch(part 1)
:	
02 08 00 00H	Performance Mode Temporary Patch(part 9)
02 09 00 00H	Temporary Rhythm Setup
02 0A 00 00H	Performance Mode Temporary Patch(part 11)
:	
02 0F 00 00H	Performance Mode Temporary Patch(part 16)

The Patch offset addresses are as follows.

00 00H	Patch Common
10 00H	Patch Tone 1
:	
16 00H	Patch Tone 4

Since Patch Tone has a size of 00 00 01 01H, we add this size to the start address of Performance Mode Temporary Patch (Part 16) Tone 4, to get:

$$\begin{array}{r} 02\ 0F\ 00\ 00H \\ \quad 16\ 00H \\ +) 00\ 00\ 01\ 01H \\ \hline 02\ 0F\ 17\ 01H \end{array}$$

Thus, the size of the retrieved data will be:

$$\begin{array}{r} 02\ 0F\ 17\ 01H \\ -) 01\ 00\ 00\ 00H \\ \hline 01\ 0F\ 17\ 01H \end{array}$$

```
F0 41 10 6A 11 01 00 00 00 01 0F 17 01 ?? F7
(1) (2) (3) (4) (5) address size checksum (6)
```

- (1) Exclusive status (2) ID number (Roland) (3) device ID(17)
 (4) Model ID (XP-60/XP-80) (5) command ID (RQ1) (6) EOX

Calculating the checksum as shown in <Example 2>, we get a message of F0 41 10 6A 11 01 00 00 00 01 0F 17 01 57 F7 to be transmitted.

● Scale Tune function (Model ID : 42H (GS), address: 40 1x 40H)

Scale Tune is a function that makes fine adjustments to the pitch of each note C—B. Settings are made for one octave, and applied to the notes of all octaves. By making Scale Tune settings you can use tunings and temperaments other than the standard Equal Temperament. Here we give three types of settings as examples.

* Scale tune messages for any parts are recognized in the patch mode.

○ Equal temperament

This temperament divides the octave into 12 equal steps, and is the temperament most frequently used today, especially in western music. Initially, the Scale Tune function of this instrument is set to Equal Temperament.

○ Just intonation (tonic of C)

The primary triads sound more beautiful in just intonation than in equal temperament. However, this applies only in one key, and chords will be discordant if you play in a different key. The settings here are for a tonic of C.

○ Arabian-type scale

The Scale Tune function allow you to use various tunings of ethnic music. Here is one of the Arabian scales.

Setting examples

Note	Equal Temp.	Just (in C)	Arabian-type scale
C	0	0	-6
C#	0	-8	+45
D	0	+4	-2
D#	0	+16	-12
E	0	-14	-51
F	0	-2	-8
F#	0	-10	+43
G	0	+2	-4
G#	0	+14	+47
A	0	-16	0
A#	0	+14	-10
B	0	-12	-49

The values in the above table are in units of 1 cent. Convert these values to hexadecimal, and transmit them as exclusive data. For example to set the Scale Tune of Part 1 to an Arabian-type scale, transmit the following data.

F0 41 10 42 12 40 11 40 3A 6D 3E 34 0D 38 6B 3C 6F 40 36 0F 76 F7

● ASCII code table

On the XP-60/80, the following ASCII code set is used for processing data such as the Patch Name and the Performance Name.

Char	Hex.	Char	Hex.	Char	Hex.
SP	20H				
A	41H	a	61H	0	30H
B	42H	b	62H	1	31H
C	43H	c	63H	2	32H
D	44H	d	64H	3	33H
E	45H	e	65H	4	34H
F	46H	f	66H	5	35H
G	47H	g	67H	6	36H
H	48H	h	68H	7	37H
I	49H	i	69H	8	38H
J	4AH	j	6AH	9	39H
K	4BH	k	6BH	!	21H
L	4CH	l	6CH	#	23H
M	4DH	m	6DH	*	2AH
N	4EH	n	6EH	+	2BH
O	4FH	o	6FH	,	2CH
P	50H	p	70H	-	2DH
Q	51H	q	71H	.	2EH
R	52H	r	72H	/	2FH
S	53H	s	73H		
T	54H	t	74H		
U	55H	u	75H		
V	56H	v	76H		
W	57H	w	77H		
X	58H	x	78H		
Y	59H	y	79H		
Z	5AH	z	7AH		

Note: SP indicates "space".

MIDI Implementation Chart

Function...		Transmitted	Recognized	Remarks
Basic Channel	Default Changed	All channel X	All channel 1 — 16	There is no specific basic channel.
Mode	Default Messages Altered	Mode 3 OMNI OFF, POLY *2 *****	X X	
Note Number :	True Voice	0 — 127 *****	0 — 127 0 — 127	
Velocity	Note ON Note OFF	O O	O O	
After Touch	Key's Ch's	O O	O O	*1 *1
Pitch Bend		O	O	*1
Control Change	0 — 119	O *1	O *1	
Program Change :	True #	O *1 *****	O *1 0 — 127	
System Exclusive		O	O	*1
System Common	: Song Pos : Song Sel : Tune	O O O	O O O	*3 *3
System Real Time	: Clock : Commands	O O	O O	*4 *3
Aux Message	: All Sound Off : Reset all controllers : Local ON/OFF : All Notes OFF : Active Sense : Sysyem Reset	O O X *5 O *6 X *7 X	O O X O (123 — 127) *6 O *7 X	
Notes	*1 O X is selectable. *2 OMNI OFF and POLY ON are transmitted on all channels upon power-up. *3 Recognized when the Sync Mode parameter (SEQUENCER/Setup/SEQ System Setup) is set to SLAVE or REMOTE. *4 Recognized when the Sync Mode parameter (SEQUENCER/Setup/SEQ System Setup) is set to SLAVE. *5 Not stored/transmitted when received, but can be created and transmitted using Microscope. *6 Mode Messages (123 — 127) are recorded and transmitted, after all currently sounding notes are turned off. The All Note Message itself is not recorded or transmitted. However, it can be created in Microscope and transmitted. *7 Transmitted/received by sound source section. Sequencer section uses them for error control if reception is interrupted.			

Mode 1 : OMNI ON, POLY
Mode 3 : OMNI OFF, POLY

Mode 2 : OMNI ON, MONO
Mode 4 : OMNI OFF, MONO

O : Yes
X : No

Specifications

XP-60/XP-80: Music Workstation

(Conforms to General MIDI System Level 1)

Synthesizer Section

Number of Parts

16 (Part 10 is Rhythm Part.)

Maximum Polyphony

64 Voices

Effects

EFX: 40 sets

Reverb: 1 set (8 types)

Chorus: 1 set

Preset Memory

Patches: 512

Performances: 64

Rhythm Sets: 8

User Memory

Patches: 128

Performances: 32

Rhythm Sets: 2

Wave Expansion Boards (sold separately)

Max. 4 Boards (A to D)

* Each Wave Expansion Board includes Patches/Rhythm Sets that make use of the waves on the board.

Sequencer Section

Tracks

Phrase Tracks (16 MIDI channels per track): 16

Pattern Tracks (16 MIDI channels per track): 1

Tempo Tracks: 1

Beat Tracks: 1

* A maximum of 100 patterns can be created in a Pattern Track.

Internal Memory

Songs: 1

Note Capacity: approx. 60,000 notes

Song Length: 9,998 measures

3.5 Inch Micro Floppy Disk (2DD/2HD)

Disk Format: 720 K bytes (2DD), 1.44 M bytes (2HD)

Note Storage: approx. 90,000 notes (2DD), approx. 180,000 notes (2HD)

Song Files: max. 99

Loadable File Formats

MRC Pro Songs

Standard MIDI Files (format 0)

Standard MIDI Files (format 1)

S-MRC Songs (from MC series sequencer)

Sound Data Files

Savable File Formats

MRC Pro Songs

Standard MIDI Files (format 0)

Standard MIDI Files (format 1)

Sound Data Files

Resolution

96 ticks per quarter note

Recording Methods

Realtime, Step

Maximum Simultaneous Input Notes (during real-time recording)

64 notes

Maximum Simultaneous Output Notes

64 notes

Tempo

♩ = 10 to 250

♩ = 5 to 500 (with the playback tempo)

Time Signatures

1 to 32/16, 1 to 32/8, 1 to 32/4, 1 to 32/2

Others

Keyboard

XP-60: 61 keys (with velocity and channel aftertouch)

XP-80: 76 keys (with velocity and channel aftertouch)

Display

320 × 80 full-dot backlit LCD

Connectors

MIX Output Jacks (stereo)

DIRECT Output Jacks (stereo)

Headphone Jack (stereo)

HOLD Pedal Jack

CONTROL Pedal Jacks (1, 2, 3, 4)

MIDI Connectors (IN, OUT, THRU)

CLICK Output Jack

Power Consumption

20 W (AC 117 V), 20 W (AC 230 V), 20 W (AC 240 V)

Dimensions

XP-60: 1,028 (W) x 349 (D) x 107 (H) mm

40-1/2 (W) x 13-3/4 (D) x 4-1/4 (H) inches

XP-80: 1,238 (W) x 349 (D) x 107 (H) mm

48-3/4 (W) x 13-3/4 (D) x 4-1/4 (H) inches

Weight

XP-60: 10.7 kg / 23 lbs 10 oz

XP-80: 12.9 kg / 28 lbs 8 oz

Accessories

Quick Start

Owner's Manual

Demonstration Disk

Dance kit Disk

Power Cable (Not included with XP-60/XP-80 designed for 117 V power supply)

Options

Wave Expansion Boards: SR-JV80 series

* In the interest of product improvement, the specifications and/or appearance of this unit are subject to change without prior notice.

Quick reference of displays

XP-80 displays are configured based on the following structure. To call up the display you desire, press the relevant buttons as follows:

Patch mode [PATCH]

Play display

Playing a Patch (p.26)

Pressing [F1] (Common)			
[F1]	(General)	Naming a Patch and setting its volume level, panning, etc.	(p.46)
[F2]	(Control)	Setting Key Assign, Portamento, etc.	(p.47)
[F3]	(Struct)	Setting how Tones are combined (structure)	(p.49)
[F4]	(K.Range)	Setting the keyboard range	(p.50)
[F5]	(V.Range)	Setting the velocity range	(p.50)
Pressing [F2] (WG)			
[F1]	(WG Prm)	Setting Wave, Tone delay, etc.	(p.51)
[F2]	(Pitch)	Setting the pitch	(p.52)
[F3]	(Pch Env)	Setting the pitch envelope	(p.53)
Pressing [F3] (TVF)			
[F1]	(TVF Prm)	Modifying sound's brightness using a filter	(p.54)
[F2]	(TVF Env)	Setting the TVF envelope	(p.54)
Pressing [F4] (TVA)			
[F1]	(TVA Prm)	Setting volume level, panning, etc. of each Tone	(p.55)
[F2]	(TVA Env)	Setting the TVA envelope	(p.56)
Pressing [F5] (LFO&Ctl)			
[F1]	(LFO 1)	Modulating sound with vibrato and tremolo	(p.57)
[F2]	(LFO 2)	Modulating sound with vibrato and tremolo	(p.57)
[F3]	(Control)	Altering sound using controllers	(p.58)
[F4]	(Ctrl Sw)	Setting how MIDI messages are received	(p.59)
Pressing [F6] (Effects)			
[F1]	(General)	Setting effects routing	(p.60)
[F2]	(EFX Prm)	Setting EFX parameters	(p.74)
[F3]	(EFX Ctl)	Modifying EFX using controllers	(p.63)
[F4]	(Chorus)	Setting chorus parameters	(p.64)
[F5]	(Reverb)	Setting reverb parameters	(p.64)
Pressing [LOCAL/TX/RX]			
[F1]	(System)	Setting Local Switch, Patch Rx-Ch and Patch Tx-Ch	(p.90)
[F2]	(Tx P.C)	Transmitting Program and Bank Select numbers to external MIDI devices	(p.182)
Pressing [SOUND LIST]			
Displaying the Patch list (Sound List window)			(p.27)

Performance mode [PERFORM]

Play display

Playing a Performance
(p.29)

Pressing [F1] (Common)			
Naming a Performance and setting Key Mode, etc.			(p.65)
Pressing [F2] (K.Range)			
Setting the keyboard range			(p.66)
Pressing [F3] (Part)			
Setting a Patch, volume level, etc. for each Part			(p.66)
Pressing [F4] (MIDI)			
Making MIDI settings for each Part			(p.67)
Pressing [F5] (Effects)			
[F1]	(General)	Setting effects routing	(p.68)
[F2]	(EFX Prm)	Setting EFX parameters	(p.74)
[F3]	(EFX Ctl)	Modifying EFX using controllers	(p.63)
[F4]	(Chorus)	Setting chorus parameters	(p.64)
[F5]	(Reverb)	Setting reverb parameters	(p.64)
Pressing [F6] (Info)*			
* Each time [F6] is pressed, the function of [F1]--[F5] will change.			
[F1]	(Mod)	Confirming the Modulation message receive status and transmitting values	(p.69)
[F2]	(Breath)	Confirming the Breath message receive status and transmitting values	(p.69)
[F3]	(Foot)	Confirming the Foot message receive status and transmitting values	(p.69)
[F4]	(Volume)	Confirming the Volume message receive status and transmitting values	(p.69)
[F5]	(Pan)	Confirming the Pan message receive status and transmitting values	(p.69)
[F1]	(Exp)	Confirming the Expression message receive status and transmitting values	(p.69)
[F2]	(Hold)	Confirming the Hold message receive status and transmitting values	(p.69)
[F3]	(Bend)	Confirming the Pitch Bend message receive status and transmitting values	(p.69)
[F4]	(Aft)	Confirming the Channel Aftertouch message receive status and transmitting values	(p.69)
[F5]	(Voices)	Confirming the number of voices used	(p.69)
[F1]	(Sys 1)	Confirming System Controller 1 message receive status and transmitting values	(p.69)
[F2]	(Sys 2)	Confirming System Controller 2 message receive status and transmitting values	(p.69)
Pressing [LOCAL/TX/RX]			
[F1]	(LcTxRx)	Setting Local Sw, Tx Switch, Rx Switch, etc. for each Part	(p.66)
[F2]	(System)	Setting Local Switch and Performance Ctrl-Ch	(p.90)
[F3]	(Tx P.C)	Transmitting Program and Bank Select numbers to external MIDI devices	(p.182)
Pressing [SOUND LIST]			
Displaying the Performance list (Sound List window)			(p.29)

Rhythm Set mode [RHYTHM]

Play display	Pressing [F1] (Common)		
		Naming a Rhythm Set	(p.70)
	Pressing [F2] (Key WG)*		
		Making Rhythm Tone settings	(p.70)
		Setting the pitch envelope	(p.70)
	Pressing [F3] (Key TVF)*		
		Modifying the Rhythm Tone's brightness	(p.71)
		Setting the TVF envelope	(p.71)
	Pressing [F4] (Key TVA)*		
		Setting the volume level and panning of a Rhythm Tone	(p.72)
	Setting the TVA envelope	(p.72)	
Playing a Rhythm Set (p.33)	Pressing [F5] (Key Ctl)		
	Altering a Rhythm Tone	(p.73)	
Pressing [F6] (Effects)			
[F1]	(General)	Setting effects routing	(p.73)
[F2]	(EFX Prm)	Setting EFX parameters	(p.74)
[F3]	(EFX Ctl)	Modifying EFX using controllers	(p.63)
[F4]	(Chorus)	Setting chorus parameters	(p.64)
[F5]	(Reverb)	Setting reverb parameters	(p.64)
Pressing [LOCAL/TX/RX]			
[F1]	(PartRx)	Setting Rx Switch for each Part and Part 10's (Rhythm Set) MIDI channel	(p.67)
[F2]	(System)	Setting Local Switch and Performance Ctrl-Ch	(p.90)
[F3]	(Tx P.C)	Transmitting Program and Bank Select numbers to external MIDI devices	(p.182)
Pressing [SOUND LIST]			
	Displaying the Rhythm Set list (Sound List window)	(p.34)	

* Each time a [F2]–[F4] is pressed, the display will change accordingly.

GM mode [SHIFT] + [PERFORM]

Play display

Playing in GM mode
(p.173)

Pressing [F4] (Part)

Setting a Patch, volume level, etc. for each Part (p.174)

Pressing [F5] (Effects)

[F1]	(General)	Setting effects routing	(p.174)
[F2]	(EFX Prm)	Setting EFX parameters	(p.74)
[F3]	(EFX Ctl)	Modifying EFX using controllers	(p.63)
[F4]	(Chorus)	Setting chorus parameters	(p.64)
[F5]	(Reverb)	Setting reverb parameters	(p.64)

Pressing [F6] (Info)*

* Each time [F6] is pressed, the functions of [F1]--[F5] will change

[F1]	(Mod)	Confirming the Modulation message receive status and transmitting values	(p.175)
[F2]	(Breath)	Confirming the Breath message receive status and transmitting values	(p.175)
[F3]	(Foot)	Confirming the Foot message receive status and transmitting values	(p.175)
[F4]	(Volume)	Confirming the Volume message receive status and transmitting values	(p.175)
[F5]	(Pan)	Confirming the Pan message receive status and transmitting values	(p.175)
[F1]	(Exp)	Confirming the Expression message receive status and transmitting values	(p.175)
[F2]	(Hold)	Confirming the Hold message receive status and transmitting values	(p.175)
[F3]	(Bend)	Confirming the Pitch Bend message receive status and transmitting values	(p.175)
[F4]	(Aft)	Confirming the Channel Aftertouch message receive status and transmitting values	(p.175)
[F5]	(Voices)	Confirming the number of voices used	(p.175)

Pressing [LOCAL/TX/RX]

[F1]	(PartRx)	Setting Rx Switch for each Part	(p.173)
[F2]	(System)	Setting Local Switch	(p.91)
[F3]	(Tx P.C)	Transmitting Program and Bank Select numbers to external MIDI devices	(p.182)

Pressing [SOUND LIST]

Displaying the GM Patch/GM Rhythm Set list (Sound List window) (p.174)

Sequencer mode [SEQUENCER]

Pressing [F1] (Setup)

[F1]	(SngName)	Naming a song	(p.118)
[F2]	(PtnName)	Naming a Pattern	(p.118)
[F3]	(TrkInfo)	Monitoring Phrase track/Pattern data and settings	(p.119)
[F4]	(RPS)	Setting RPS parameters	(p.150)
[F6]	(SEQ Sys)	Making setups for using the XP-80 in combination with external MIDI devices and metronome settings	(p.117)

Pressing [F2] (Quantiz)

[F1]	(Grid)	Performing Grid Quantize	(p.137)
[F2]	(Shuffle)	Performing Shuffle Quantize	(p.138)
[F3]	(Groove)	Performing Groove Quantize	(p.139)
[F4]	(Load)	Loading a user groove template	(p.142)
[F5]	(Save)	Saving a user groove template file	(p.143)

Pressing [F3] (TrkEdit)*

* Each time [F6] is pressed, the Menu 1-3 will change.

Menu 1

[F1]	(Erase)	Erasing unwanted sequencer data area	(p.123)
[F2]	(Delete)	Deleting unwanted sequencer data	(p.124)
[F3]	(Copy)	Copying a phrase	(p.124)
[F4]	(Insert)	Inserting blank measures (Insert Measure)	(p.126)
[F5]	(Trans)	Transposing pitch (Transpose)	(p.126)

Menu 2

[F1]	(Chg Vel)	Modifying velocity (Change Velocity)	(p.127)
[F2]	(Chg Ch)	Changing MIDI channel (Change MIDI Channel)	(p.128)
[F3]	(Chg Gt)	Modifying the note length (Change Gate Time)	(p.129)
[F4]	(Merge)	Merging two Phrase tracks/Patterns into one	(p.130)
[F5]	(Extract)	Extracting part of sequencer data from a Phrase track/Pattern and moving it to another Phrase track/Pattern	(p.131)

Menu 3

[F1]	(Shift)	Shifting sequencer data backward or forward (Shift Clock)	(p.132)
[F2]	(Thin)	Thinning out sequencer data (Data Thin)	(p.133)
[F3]	(Exchg)	Exchanging two Phrase tracks/Patterns (Exchange)	(p.134)
[F4]	(TimeFit)	Adjusting the song playback time	(p.134)
[F5]	(Truncat)	Deleting blank measures (Truncate)	(p.135)

Pressing [F4] (Micro)

		Viewing recorded sequencer data (Microscope display)	(p.144)
[F1]	(Create)	Inserting new sequencer data	(p.147)
[F2]	(Erase)	Erasing sequencer data	(p.149)
[F3]	(Move)	Moving sequencer data	(p.149)
[F4]	(Copy)	Copying sequencer data	(p.149)
[F5]	(Place)	Pasting copied sequencer data	(p.149)
[REC]		Step recording	(p.113)

Pressing [F5] (Loop)

		Setting loop play parameters	(p.120)
--	--	------------------------------	---------

Play display (Song)

Playing back a song
(p.98)

Play display (Pattern)

Playing back a Pattern
(p.101)

Pressing [F6] (List)		
	Displaying the song list (Song List window)	(p.98)
Pressing [REC]		
	Getting ready for realtime recording	(p.106)
[F1]	(->Part) Setting parameters of each Part	(p.111)
[F2]	(->Info) Checking MIDI messages received by each Part	(p.111)
[F3]	(Rec Sel) Recording specific sequencer data only	(p.109)
[F4]	(Quantiz) Performing quantization at recording	(p.106)
[F5]	(Loop) Setting Loop recording parameters	(p.120)
[F6]	(A.Punch) Setting Punch points (auto punch-in recording area)	(p.108)
[START/STOP]	Starting recording	(p.106)
	<During recording (Mix)>	
[F5]	(Erase) Deleting unwanted data during recording (Realtime Erase)	(p.110)
	<During recording (except manual punch-in recording)>	
[F6]	(Rehral) Checking instrument sounds or phrases during recording	(p.109)
	<During recording (Manual punch-in recording)>	
[F6]	(PunchIn) Performing manual punch-in recording	(p.109)
	<During tempo change recording>	
[F6]	(Tap) Recording tempo changes using Tap Tempo function	(p.110)
Pressing [LOCATE]		
	Setting Locate positions or moving to a Locate position	(p.119)

Chain Play mode [CHAIN PLAY]

Play display Playing songs in sequence (Chain Play) (p.154)	Pressing [F1] (Insert) Inserting a step (song/data file) (p.153)
	Pressing [F2] (Delete) Deleting a step (song/data file) (p.153)
	Pressing [F3] (Clr All) Deleting all chains stored in XP-80 memory (p.153)
	Pressing [F5] (Save) Saving a chain file (p.154)
	Pressing [F6] (List) Displaying the chain file list (Chain File List window) (p.154)

System mode [SYSTEM]

Pressing [F1] (Setup) Adjusting LCD contrast, keyboard touch, etc. (p.88)
Pressing [F2] (Tune) Adjusting tuning (p.89)
Pressing [F3] (MIDI)* Setting Local Switch, Performance Ctrl-Ch, etc. (p.90) Setting MIDI message receive/transmit parameters (p.91) Setting the Bank Select group (p.91)
Pressing [F4] (Control)* Assigning functions to C1/C2 sliders and System Controllers 1 and 2 (p.92) Assigning functions to Pedals 1--4 and the Hold Pedal (p.92) Making controller settings (p.93)
Pressing [F5] (Arpeg) Making arpeggio settings (p.93)
Pressing [F6] (Info) Confirming the Wave Expansion Boards installed and the XP-80's battery status (p.95)

* Each time [F3] and [F4] is pressed, the display will change

Utility mode [UTILITY]

* Each time [F6] is pressed, the Menu 1-3 will change.

Menu 1

Pressing [F1] (Write)

Writing Patch, Performance or Rhythm Set settings into memory (p.156)

Pressing [F2] (Copy)

Copying Patch, Performance or Rhythm Set settings (p.157)

Pressing [F3] (Init)

Resetting Patch, Performance or Rhythm Set settings to default factory settings (Initialize) (p.160)

Pressing [F4] (Xfer)

Transmitting Patch, Performance or Rhythm Set settings (Data Transfer) (p.161)

Pressing [F5] (Protect)

Preventing user memory from being rewritten (User Memory Protect) (p.164)

Menu 2

Pressing [F1] (SnglInit)

Clearing the internal song (Song Initialize) (p.164)

Pressing [F2] (Memory)

Checking the amount of data in internal memory (Internal Memory Information) (p.164)

Menu 3

Pressing [F1] (Factory)

Resetting all the settings stored in XP-80 to the factory default settings (Factory Preset) (p.165)

Menu display

Selecting a Utility function (p.155)

Disk mode [DISK]

* Each time [F6] is pressed, the fthe Menu 1-3 will change.

Menu 1

Pressing [F1] (Load)

Loading data from disk into the XP-80 memory (p.167)

Pressing [F2] (Save)

Saving data to disk (p.168)

Pressing [F3] (Format)

Formatting a disk (p.169)

Pressing [F4] (Backup)

Creating a backup disk (p.170)

Pressing [F5] (Verify)

Checking files on disk (p.170)

Menu 2

Pressing [F1] (Volume)

Assigning a new name (volume label) to a disk (Change Volume Label) (p.170)

Pressing [F2] (Delete)

Deleting unwanted files from disk (p.171)

Pressing [F3] (Rename)

Renaming a file (p.171)

Menu 3

Pressing [F1] (Info)

Displaying remaining disk memory, etc. (Disk Information) (p.172)

Menu display

Selecting a disk-related function (p.166)

Index

-
- A**
Arpeggiator35–37, 93
Auto calculate the check sum146
Auto punch-in.....104, 108
- B**
Backup170
Beat track96
Bulk dump.....161
- C**
Chain file.....97, 154, 168
Chain play153
Chain play mode20, 153, 154
Change gate time.....129
Change MIDI channel.....128
Change velocity127
Change volume label170
Chorus.....39, 40, 60, 64
Compare156
Control Channel90
Control depth.....58, 59
Control destination58, 59
Control source.....48, 59
Controller.....48, 49, 58, 59
Copy
 GM mode176
 Microscope edit.....149
 Patch/Performance/Rhythm set.....158/157/159
 Track edit124
Count in107
Create147, 148
Ctrl 1–3 (Controller 1–3)48, 49, 58, 59
Cursor23
Cursor buttons.....15, 23
- D**
Data file.....45, 168
Data reduce165
Data thin133
Data Transfer
 GM mode177
 Patch/Performance/Rhythm set.....161–163
Delete
 Disk mode.....171
 Track edit124
Digit hold function.....27, 29, 34
Disk.....45, 96, 166–172
Disk information172
Disk mode20, 166–172
Display groups.....6, 20
Display name6, 20
- E**
Edit
 Editing area.....122
 Editing a GM174
 Editing a Patch40–42, 46–65
 Editing a Performance43, 65–69
 Editing a Rhythm set.....44, 70–73
 Microscope edit.....144–149
 Track edit121–135
 Quantize.....136–143
- Effects
 Chorus.....39, 40, 60, 64
 EFX.....39, 40, 60–64
 EFX Parameter.....74–88
 Examples of Routing effects.....61–63
 Reverb.....39, 40, 60, 64
 Routing effects.....60
 Effects on/off40
- EFX39, 40, 60
- Envelope
 Pitch envelope53
 TVA envelope.....56
 TVF envelope54
- Erase
 Track edit123
 Microscope edit.....149
 Erasing unwanted data during recording
 (Realtime Erase)110
- Exchange.....134
EXP-A-D Slot.....45
Extract131
- F**
Factory presets165
- File
 Chain file.....97, 154, 168
 Data file45, 168
 Song file.....96, 168
 Standard MIDI file.....97, 168
 User groove template file143, 168
File list window166
File name.....97, 168
File number166
Format.....169
Function buttons.....14, 20
- G**
GM mode.....20, 173–177
Grid quantize137
Groove quantize139
- I**
Information
 Disk information.....172
 Internal memory information.....164
 Part information (GM)175
 Part information (Performance)69
 System information95
 Track information.....119
Initialize
-

GM mode	176	Muting Phrase tracks	100
Patch/Performance/Rhythm set.....	160	Muting the Tempo track.....	101
Song Initialize.....	105, 164	N	
Insert Measure	126	Name	
Internal memory.....	96	Assigning a name	24
Internal Song.....	96, 97	File name.....	97, 168
K		Patch name	26
Key Assign	28, 47	Pattern name	101, 118
L		Performance name.....	29
Layer.....	30	Rhythm set name	33
Layer performance.....	29, 30, 65	Song name	97, 118
Load		Volume label.....	97, 170
Chain file.....	154	Name window	24
Song/File	167	Non-stop loop recording.....	109
User groove template.....	142	Number	
User groove template file	143	File number.....	166
Local switch (Performance)	30, 67	Patch number	26, 181
Local switch (System)	90, 91	Pattern number	101
LOCAL/TX/RX window.....	30	Performance number.....	29, 181
Locate function	119	Rhythm set number	33, 181
Loop play.....	97, 102, 120	Song number	97
Loop recording	106, 120	Numeric keys.....	16, 23
Loop window.....	120	Numeric keys Special functions of the numeric keys.....	24, 25
M		O	
Manual punch-in.....	104, 109	Octave Shift function	37
Memory		P	
Internal memory	96	Palette display.....	41, 43
Preset memory	45	Panic function	38
System memory	45	Parameters	
Temporary area.....	45	EFX.....	74–78
User memory.....	45	GM	174, 175
Merge	130	Patch	46–65
Metronome	117	Performance.....	65–69
Microscope edit		System	88–95
Copy	149	Rhythm set.....	70–73
Create.....	147, 148	Part	19
Erase	149	Turning on/off a part.....	31
Move.....	149	Selecting a part.....	31
MIDI channel	67, 104	Part information (GM).....	175
MIDI Update function	99	Part information (Performance)	69
Mix.....	104	Patch.....	18
Mode		Patch group	26, 181
Chain play mode.....	20, 153, 154	Patch mode	20, 26–28, 40–42, 46–65
Disk mode.....	20, 166–172	Patch number	26, 181
Patch mode	20, 26–28, 40–42, 46–65	Patch parameters	46–65
Performance mode	20, 29–32, 43, 65–69	Selecting a Patch	26
Rhythm set mode.....	20, 33, 34, 44, 70–73	Editing a Patch	40–42, 46–65
Sequencer mode.....	20, 96–152	Patch receive channel.....	26, 90
System mode	20, 88–95	Patch transmit channel	26, 90
Utility mode.....	20, 155–165	Pattern	
MRC Pro song.....	96	Assigning a Pattern to a Phrase track.....	114
Multitimbral sound source	20	Playing back a Pattern.....	101
Mute			

Playing back a Patterns by pressing keys (RPS)	151	Rhythm set number	33, 181
Pattern beat	147	Rhythm set parameters	70–73
Pattern call message	145, 147	Selecting a Rhythm set	33
Pattern track	96	RPS	150–152
Peak&Hold	48	S	
Performance	18	Save	
Editing a Performance	43, 65–69	Chain file	154
Layer performance	29, 30, 65	Song/File	168
Performance group	29, 181	User groove template file	142
Performance mode	20, 29–32, 43, 65–69	User groove template	143
Performance number	29, 181	Sequencer	18, 20, 96
Performance parameters	65–69	Sequencer mode	20, 96–154
Single performance	29, 31, 65	Shift clock	132
Selecting a Performance	29	Shuffle quantize	138
Phrase tracks	96	Simultaneous voices	182
Playback tempo	97, 101, 145	Single Performance	29, 31, 65
Playing back a song		Slot (EXP-A–D)	45
Chain play	154	Solo	28
Loop play	97, 102, 120	Song	96
Playing back a S-MRC song	102	Song initialize	105, 164
Quick play	98	Song list window	98
Portamento	28	Song File	96, 168
Portamento settings	47	Song Name	97, 118
Preset groove template	139, 140	Song number	97
Preset memory	45	Sound list window	
Preview	136	GM	174
Q		Patch	27
Quantize		Performance	29
Grid quantize	106, 107, 137	Rhythm set	34
Groove quantize	139	Wave	51
Recording quantize	106, 107	Sound Palette	
Shuffle quantize	106, 107, 138	Changing sound characters (Patch)	28
Quick play	98	Changing sound characters (Performance)	32
R		Changing the volume of each Part	32
Realtime erase	110	Changing the volume of each tone	28
Realtime phrase sequence (RPS)	151	Transmitting MIDI messages using the Sound	
Realtime recording		Palette (GM)	175
Auto punch-in	104, 108	Transmitting MIDI messages using the Sound	
Manual punch-in	104, 109	Palette (Performance)	69
Mix	104	Sound Source	18, 20
Replace	104	Split	30
Recording		Standard MIDI file	97, 168
Realtime recording	106–112	Step recording	113–115
Step recording	113–115	SVQ format	96, 168
Recording quantize	106, 107	System Exclusive message	
Recording select window	109	Modifying System Exclusive messages	146
Rehearsal	109	System information	95
Rename	171	System memory	45
Replace	104	System mode	20, 88–95
Reverb	39, 40, 60, 64	System parameters	88–95
Rhythm set	19	System parameter window	90, 91
Editing a Rhythm set	44, 70–73	T	
Rhythm set group	33, 181	Tap tempo function	100
Rhythm set mode	20, 33, 34, 44, 70–73	Template	

Preset groove template	139, 140	Modifying a volume label	170
User groove template	142, 143	W	
Tempo		Wave Expansion board	
Muting the Tempo track	101	Installing a Wave Expansion board	45
Playback tempo	97, 101, 145	Window	
Recording tempo changes	110	File list window	166
Tempo change	145	LOCAL/TX/RX window	30
Tempo track	96	Locate window	120
Temporary area	45	Loop window	120
Test out	144	Name window	24
Time fit	134	Recording select window	109
Tone	18	Song list window	98
Turning on/off a tone	27	Sound list window	27, 29, 34, 51, 174
Selecting a tone	40	System parameter window	90, 91
Tone delay	51	Template list window	142, 143
Track		Transmit program change window	182
Beat track	96	Write	156
Pattern track	96		
Phrase track	96		
Tempo track	96		
Track edit			
Change MIDI channel	128		
Change gate time	129		
Change velocity	127		
Copy	124		
Data thin	133		
Delete	124		
Erase	123		
Exchange	134		
Extract	131		
Insert measure	126		
Merge	130		
Shift clock	132		
Time fit	134		
Transpose	126		
Truncate	135		
Track information	119		
Transmit program change window	182		
Transpose			
Transpose	38		
Transpose (Track edit)	126		
Tuning	89		
U			
Undo/Redo	24, 112, 115, 122, 136, 148, 149		
User groove template	142, 143		
User groove template file	143, 168		
User memory	45		
User memory protect	164		
Utility mode	155–165		
V			
Verify	170		
Voice priority	47		
Voice reserve	67		
Volume label	97, 170		

Information

When you need repair service, call your nearest Roland Service Center or authorized Roland distributor in your country as shown below.

AFRICA

EGYPT

Al Fanny Trading Office
P.O. Box 2904,
El Horrieh Heliopolis, Cairo,
EGYPT
TEL: (02) 4185531

REUNION

Maison FO - YAM Marcel
25 Rue Jules Mermet
Chaudron - BP79 97491
Ste Clotilde REUNION
TEL: 28 29 16

SOUTH AFRICA

**That Other Music Shop
(PTY) Ltd.**

11 Melle Street (Cnr Melle and
Juta Street)
Braamfontein 2001
Republic of SOUTH AFRICA
TEL: (011) 403 4105

Paul Bothner (PTY) Ltd.

17 Werdmüller Centre Claremont
7700
Republic of SOUTH AFRICA

P.O. Box 23032

Claremont, Cape Town
SOUTH AFRICA, 7735
TEL: (021) 64 4030

ASIA

CHINA

**Beijing Xinghai Musical
Instruments Co., Ltd.**
6 Huangmchang Chao Yang
District, Beijing, CHINA
TEL: (010) 6774 7491

HONG KONG

**Tom Lee Music Co., Ltd.
Service Division**
22-32 Pun Shan Street, Tsuen
Wan, New Territories,
HONG KONG
TEL: 2415 0911

INDIA

Rivera Digitec (India) Pvt. Ltd.
409, Nirman Kendra Mahalaxmi
Flats Compound Off. Dr. Edwin
Moses Road, Mumbai-400011,
INDIA
TEL: (022) 498 3079

INDONESIA

PT Citra Inti Rama
Jl. Cideng Timur No. 15J-150
Jakarta Pusat
INDONESIA
TEL: (021) 6324170

KOREA

**Cosmos Corporation
Service Station**
261 2nd Floor Nak-Won Arcade
Jong-Ro ku, Seoul, KOREA
TEL: (02) 742 8844

MALAYSIA

Bentley Music SDN BHD
140 & 142, Jalan Bukit Bintang
55100 Kuala Lumpur, MALAYSIA
TEL: (03) 2443333

PHILIPPINES

G.A. Yupangco & Co. Inc.
339 Gil J. Puyat Avenue
Makati, Metro Manila 1200,
PHILIPPINES
TEL: (02) 899 9801

SINGAPORE

Swee Lee Company
150 Sims Drive,
SINGAPORE 387381
TEL: 748-1669

CRISTOFORI MUSIC PTE LTD

Blk 3014, Bedok Industrial Park E,
#02-2148, SINGAPORE 489980
TEL: 243 9555

TAIWAN

**ROLAND TAIWAN
ENTERPRISE CO., LTD.**
Room 5, 9fl. No. 112 Chung Shan
N.Road Sec.2, Taipei, TAIWAN,
R.O.C.
TEL: (02) 2561 3339

THAILAND

Theera Music Co., Ltd.
330 Verg NakornKasem, Soi 2,
Bangkok 10100, THAILAND
TEL: (02) 2248821

VIETNAM

Saigon Music
138 Tran Quang Khai St.,
District 1
Ho Chi Minh City
VIETNAM
TEL: (08) 844-4068

AUSTRALIA/ NEW ZEALAND

AUSTRALIA

**Roland Corporation
Australia Pty., Ltd.**
38 Campbell Avenue
Dee Why West, NSW 2099
AUSTRALIA
TEL: (02) 9982 8266

NEW ZEALAND

Roland Corporation (NZ) Ltd.
97 Mt. Eden Road, Mt. Eden,
Auckland 3, NEW ZEALAND
TEL: (09) 3098 715

CENTRAL/LATIN AMERICA

ARGENTINA

Instrumentos Musicales S.A.
Florida 656 2nd Floor
Office Number 206A
Buenos Aires
ARGENTINA, CP1005
TEL: (54-11) 4-393-6057

BRAZIL

Roland Brasil Ltda.
R. Coronel Octaviano da Silveira
203 05522-010
Sao Paulo BRAZIL
TEL: (011) 3743 9377

CHILE

Comercial Fancy S.A.
Avenida Rancagua #0330
Providencia Santiago, CHILE
TEL: 56-2-373-9100

EL SALVADOR

OMNI MUSIC
75 Avenida Notre y Alameda
Juan Pablo 2 No. 4010
San Salvador, EL SALVADOR
TEL: (503) 262-0788

MEXICO

Casa Veerkamp, s.a. de c.v.
Av. Toluca No. 323 Col. Olivar de
los Padres 01780 Mexico D.F.
MEXICO
TEL: (525) 668 04 80

La Casa Wagner de

Guadalajara s.a. de c.v.
Av. Corona No. 202 S.J.
Guadalajara, Jalisco Mexico
C.P.44100 MEXICO
TEL: (3) 613 1414

PANAMA

Productos Superiores, S.A.
Apartado 655 - Panama 1
REP. DE PANAMA
TEL: (507) 270-2200

URUGUAY

Todo Music
Cuareim 1488, Montevideo,
URUGUAY
TEL: 5982-924-2335

VENEZUELA

Musicland Digital C.A.
Av. Francisco de Miranda,
Centro Parque de Cristal, Nivel
C2 Local 20 Caracas
VENEZUELA
TEL: (02) 285 9218

EUROPE

AUSTRIA

Roland Austria GES.M.B.H.
Siemensstrasse 4, P.O. Box 74,
A-6063 RUM, AUSTRIA
TEL: (0512) 26 44 260

BELGIUM/HOLLAND/ LUXEMBOURG

Roland Benelux N. V.
Houtstraat 3 B-2260 Oevel
(Westerlo) BELGIUM
TEL: (014) 575811

DENMARK

Roland Scandinavia A/S
Nordhavnsvej 7, Postbox 880
DK-2100 Copenhagen
DENMARK
TEL: (039) 16 6200

FRANCE

Roland France SA
4, Rue Paul Henri SPAAK
Parc de l'Esplanade F 77 462 St.
Thibault Lagny Cedex FRANCE
TEL: 01 600 73 500

FINLAND

**Roland Scandinavia As,
Filial Finland**
Lauttasaarentie 54 B
Fin-00201 Helsinki, FINLAND
TEL: (9) 682 4020

GERMANY

**Roland Elektronische
Musikinstrumente
Handelsgesellschaft mbH.**
Oststrasse 96, 22844 Norderstedt,
GERMANY
TEL: (040) 52 60090

GREECE

**STOLLAS S.A.
Music Sound Light**
155, New National Road
26422 Patras, GREECE
TEL: 061-435400

HUNGARY

Intermusica Ltd.
Warehouse Area 'DEPO' Pf.83
H-2046 Torokbalint, HUNGARY
TEL: (23) 511011

IRELAND

Roland Ireland
Audio House, Belmont Court,
Donnybrook, Dublin 4,
Republic of IRELAND
TEL: (01) 2603501

ITALY

Roland Italy S. p. A.
Viale delle Industrie, 8
20020 Arese Milano, ITALY
TEL: (02) 937-78300

NORWAY

**Roland Scandinavia Avd.
Kontor Norge**
Lilleakerveien 2 Postboks 95
Lilleaker N-0216 Oslo
NORWAY
TEL: 273 0074

POLAND

P. P. H. Bzostowicz
UL. Gibraltarska 4.
PL-03664 Warszawa POLAND
TEL: (022) 679 44 19

PORTUGAL

**Tecnologias Musica e Audio,
Roland Portugal, S.A.**
RUA SANTA CATARINA
131 - 4000 Porto -PORTUGAL
TEL: (02) 208 44 56

ROMANIA

FBS LINES
Plata Libertatii 1.
RO-4200 Cheorgheni
TEL: (066) 164-609

RUSSIA

Slami Music Company
Sadojava-Triumfalnaja st., 16
103006 Moscow, RUSSIA
TEL: 095 209 2193

SPAIN

**Roland Electronics
de España, S. A.**
Calle Bolivia 239 08020 Barcelona,
SPAIN
TEL: (93) 308 1000

SWEDEN

**Roland Scandinavia A/S
SWEDISH SALES OFFICE**
Danvik Center 28, 2 tr.
S-131 30 Nacka SWEDEN
TEL: (08) 702 0020

SWITZERLAND

**Roland (Switzerland) AG
Musitronic AG**
Gerberstrasse 5, CH-4410 Liestal,
SWITZERLAND
TEL: (061) 921 1615

UKRAINE

TIC-TAC
Mira Str. 19/108
P.O. Box 180
295400 Munkachevo, UKRAINE
TEL: (03131) 414-40

UNITED KINGDOM

Roland (U.K.) Ltd.
Atlantic Close, Swansea
Enterprise Park SWANSEA
SA7 9FJ,
UNITED KINGDOM
TEL: (01792) 700139

MIDDLE EAST

BAHRAIN

Moon Stores
Bab Al Bahrain Road,
P.O. Box 20077
State of BAHRAIN
TEL: 211 005

CYPRUS

Radex Sound Equipment Ltd.
17 Diagorou St., P.O. Box 2046,
Nicosia CYPRUS
TEL: (02) 453 426

ISRAEL

**Halilit P. Greenspoon &
Sons Ltd.**
8 Retzif Fa'aliya Hashnya St.
Tel-Aviv-Yaho ISRAEL
TEL: (03) 6823666

JORDAN

AMMAN Trading Agency
Prince Mohammed St. P.O. Box
825 Amman 11118 JORDAN
TEL: (06) 4641200

KUWAIT

Easa Husain Al-Yousifi
P.O. Box 126 Safat 13002
KUWAIT
TEL: 5719499

LEBANON

A. Chahine & Fils
P.O. Box 16-5857 Gergi Zeidan St.
Chahine Building, Achrafieh
Beirut, LEBANON
TEL: (01) 335799

OMAN

**OHI Electronics & Trading
Co. LLC**
P.O. Box 889 Muscat
Sultanate of OMAN
TEL: 959085

QATAR

Badie Studio & Stores
P.O. Box 62,
DOHA QATAR
TEL: 423554

SAUDI ARABIA

**aDawliah Universal
Electronics APL**
P.O. Box 2154 ALKHOBAR 31952,
SAUDI ARABIA
TEL: (03) 898 2081

SYRIA

**Technical Light & Sound
Center**
Khaled Ibn Al Walid St.
P.O. Box 13520
Damascus - SYRIA
TEL: (011) 2235 384

TURKEY

**Barkat Muzik aletleri ithalat
ve ihracat limited ireketi**
Straselviler Cad. Billurcu Sok.
Mucadelle Cikmeze No. 11-13
Taksim. Istanbul, TURKEY
TEL: (0212) 2499324

U.A.E.

**Zak Electronics & Musical
Instruments Co.**
Zabeel Road, Al Sherooq Bldg.,
No. 14, Grand Floor DUBAI
U.A.E.
P.O. Box 8050 DUBAI, U.A.E.
TEL: (04) 360715

NORTH AMERICA

CANADA

**Roland Canada Music Ltd.
(Head Office)**
5480 Parkwood Way Richmond
B. C. V6V 2M4 CANADA
TEL: (0604) 270 6626

Roland Canada Music Ltd.

(Toronto Office)
Unit 2, 109 Woodbine Downs
Blvd, Etobicoke, ON
M9W 6Y1 CANADA
TEL: (0416) 213 9707

U. S. A.

Roland Corporation U.S.
5100 S. Eastern Avenue
Los Angeles, CA 90040-2938,
U. S. A.
TEL: (323) 890 3700

As of June 11, 1999

For EU Countries

Apparatus containing Lithium batteries

ADVARSEL!

Lithiumbatteri - Eksplosionsfare ved fejlagtig håndtering.
Udskiftning må kun ske med batteri af samme fabrikat og type.
Levér det brugte batteri tilbage til leverandøren.

ADVARSEL

Ekspløsjonsfare ved feilaktig skifte av batteri.
Benytt samme batteritype eller en tilsvarende type anbefalt av apparatfabrikanten.
Brukte batterier kasseres i henhold til fabrikantens instruksjoner.

CAUTION

Danger of explosion if battery is incorrectly replaced.
Replace only with the same or equivalent type recommended by the manufacturer.
Discard used batteries according to the manufacturer's instructions.

VARNING

Eksplosjonsfara ved felaktigt batteribyte.
Använd samma batterityp eller en ekvivalent typ som rekommenderas av apparattillverkaren.
Kassera använt batteri enligt fabrikantens instruktion.

VAROITUS

Paristo voi räjähtää, jos se on virheellisesti asennettu.
Vaihda paristo ainoastaan laitevalmistajan suosittelemaan tyyppiin. Hävitä käytetty paristo valmistajan ohjeiden mukaisesti.

For EU Countries



This product complies with the requirements of European Directives EMC 89/336/EEC and LVD 73/23/EEC.

For the USA

FEDERAL COMMUNICATIONS COMMISSION RADIO FREQUENCY INTERFERENCE STATEMENT

This equipment has been tested and found to comply with the limits for a Class B digital device, pursuant to Part 15 of the FCC Rules. These limits are designed to provide reasonable protection against harmful interference in a residential installation. This equipment generates, uses, and can radiate radio frequency energy and, if not installed and used in accordance with the instructions, may cause harmful interference to radio communications. However, there is no guarantee that interference will not occur in a particular installation. If this equipment does cause harmful interference to radio or television reception, which can be determined by turning the equipment off and on, the user is encouraged to try to correct the interference by one or more of the following measures:

- Reorient or relocate the receiving antenna.
- Increase the separation between the equipment and receiver.
- Connect the equipment into an outlet on a circuit different from that to which the receiver is connected.
- Consult the dealer or an experienced radio/TV technician for help.

Unauthorized changes or modification to this system can void the users authority to operate this equipment.
This equipment requires shielded interface cables in order to meet FCC class B Limit.

For Canada

NOTICE

This Class B digital apparatus meets all requirements of the Canadian Interference-Causing Equipment Regulations.

AVIS

Cet appareil numérique de la classe B respecte toutes les exigences du Règlement sur le matériel brouilleur du Canada.

